

MODERN WIRELESS



1/-

Vol. 1. No. 6.

Edited by JOHN SCOTT-TAGGART, F.Inst.P., Member I.R.E.

July, 1923



No. 6

AN "S.T.100" SET FOR THE BEGINNER. *By* PERCY W. HARRIS.
 TWO-VALVE CIRCUITS. *By* JOHN SCOTT-TAGGART, F. Inst. P.
 SPEAKING BY LIGHT. *By* PROFESSOR A. O. RANKINE, D.Sc.
 EXPERIMENTS WITH THE S.T.100 CIRCUIT, *By* JOHN SCOTT-TAGGART, F. Inst. P.

How to make three different Broadcast Receivers.

Practical Hints for the Constructor.
Wave Set.

Free Templates for Drilling Valve Sockets.
How to Make a Wave-Meter.

How to Make a Long-Apparatus Tested.
Summer Time Radio.



Western Electric
ASSEMBLY No. 5

Consists of:—

Western Electric Frame Aerial Receiving Set, complete.

Western Electric Two-Stage Amplifier.

Western Electric Small Pattern (No. 44003) Loud Speaking Receiver.

The Western Electric Frame Aerial gives the maximum efficiency, and being constructed with enclosed wires, its appearance and excellent finish make it suitable for use in a room where the furniture and fittings have been the result of careful study and good taste.

The Detector is specially designed for use with the Frame Aerial and consists of three high frequency valves for detecting and tuning. It will operate without any earth connection or external aerial.

The Western Electric Low Frequency Amplifier is already well known, as also are Western Electric Loud Speaking Receivers, which have no equal for true reproduction and clarity of tone.

The whole assembly is neat and compact and gives the most satisfactory results.

Western Electric

MAKERS OF OVER HALF THE WORLD'S TELEPHONES.

WHOLESALE ONLY

CONNAUGHT HOUSE, ALDWYCH, LONDON, W.C.

Telephone: Central 7345 (9 lines).

BRANCHES: BIRMINGHAM, LEEDS, CARDIFF, MANCHESTER, NEWCASTLE, GLASGOW, SOUTHAMPTON.

STERLING

RADIO INSTRUMENTS

add a new enjoyment to the garden and the country.

INDISPENSABLE FOR THE
CARAVAN, LAUNCH, MOTOR,
GARDEN, PICNIC, etc., etc.

"STERLING" Combined Valve and Crystal Receiving Set—using High and Low Tension Dry Batteries, together with "STERLING" Head Telephones, is the ideal combination for the purpose.

Obtainable from all Electrical Dealers and Stores.

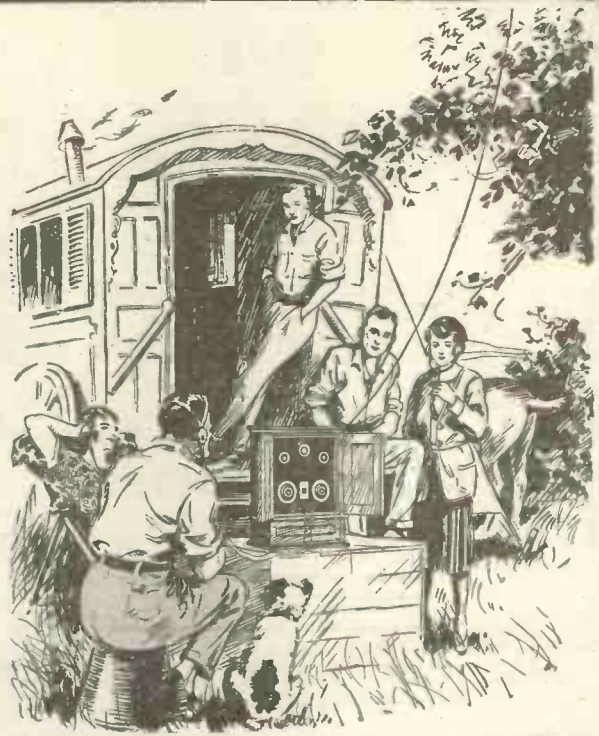

STERLING TELEPHONE AND ELECTRIC COMPANY, LIMITED,

Manufacturers of Telephones and Radio Apparatus, etc. (WHOLESALE ONLY.)

TELEPHONE HOUSE, 210-212 TOTTENHAM COURT RD., LONDON, W.1

Telephone: Museum 4144 (7 lines).

Telegrams: "Cucumis, Wesdo, London."

BIRMINGHAM: 150, Edmund Street.

CARDIFF: 10, Park Place.

MANCHESTER: 14, St. Peter's Square.

NEWCASTLE-ON-TYNE: 9, Clavering Place.

WORKS: Dagenham, Essex.



It answers your queries



If you are at all keen and enthusiastic you will continually find little queries which will puzzle you. Exactly what is Reaction? How does a Valve oscillate? What is Tuning? These are the sort of questions answered in this new Book by the Editor of *Modern Wireless*. Get a copy to-day—master its contents and you will begin to make real progress at once.

2/6

From all Booksellers or 2/3 post free.
Radio Press Ltd.
Devereux Court,
Strand, W.C.2.

Wireless Valves simply explained
By John Scott-Taggart F. Inst.P.

We are only accepting direct orders

Just issued— Wireless Map of Great Britain

THIS new map has been prepared under expert supervision, and gives the following useful information:—
All places with transmitting apparatus are shown in black. Call signs applying to these in red. Broadcasting, Commercial, Aviation, and Amateur and Experimental Transmitting Stations are all indicated by special symbols, also in red. Admiralty, Naval and Trinity House Stations specially shown in blue. A Complete Index to all Amateurs and Experimental Stations appears on the map, the origin of a call-sign being at once located by means of numbered squares. Diagrams with Compass bearings show the direction of important Overseas Stations in relation to different portions of the map. London and District: An inset map on an enlarged scale (1½ miles to 1 in.) clearly shows the stations within this area.

2/6

PRICES
On Paper folded in Cover 2/6 net, postage 2d.
Mounted on cloth folded in Case. 5/6 net, postage 4d.
Mounted on Cloth and Varnished, with Rollers. 7/6 net, postage 9d.

RADIO PRESS, Ltd., Devereux Court, STRAND, W.C.2.

**THE
QUALITY
EBONITE**

The result of over 70 years' experience in the manufacture of this material.

Large stocks kept in London for immediate delivery of :

- | | |
|---------------|--------------|
| SHEETS | DIALS |
| RODS | KNOBS |
| TUBES | Etc. |

WHOLESALE ONLY.

**AMERICAN HARD RUBBER CO.
(Britain) LTD.**

13a, Fore Street, London, E.C.2.
Telephone: 12754 Central. Telegraphic Address: "Eboniseth, Ave., London."

Dependable Radio Service

Aerial Wire, 7/22 bare copper stranded.. 100 feet	s. d.	2 6
Insulators, Reel 1½d., Egg 3d., Shell		6
Variometers, silk wound, fitted with ebonite dial and knob		4 6
Crystal Receiving Set, Variometer tuning		10 0
Unassembled		7 0
Crystal Detectors, on ebonite base 3s. 0d. and Glass covered		2 0
" "		3 6
Oojah Basket Coils, set of 7. 150-4,000 metres Slab		5 0
" " "		7 6
Basket Coils, our Special Line, set of 6. 170-3,500 "		2 6
Coil Holders, 3 Way		8 6
" " "	Extraordinary Value	6 6
Interval Transformers, not rubbish, 12s., 12s. 6d. and		16 6
Valves, soft Dutch. Ideal for detecting		10 6
" " " "	amplification	11 6
Amplion Loud Speakers upwards from £2		12 6
Variable Condensers: For Panel Mounting. In Celluloid Case		
.001	12s. 6d.	15s. 0d.
.0005	10s. 6d.	13s. 0d.
.0003	9s. 6d.	11s. 0d.

HEADPHONES.

" Sidpe " 4000 ohms.	£1 0 0	8000 ohms	£1 2 6
" British " 4000 "	£1 0 0	B.B.C. 8000 "	£1 2 6
" Brunet " 4000 "	£1 2 6	" Pival " "	£1 2 6

**THE WATERLOO ELECTRIC CO.
129, Waterloo Road, S.E.1.**

Closed on Thurs. 1 p.m. Sat. 9 p.m., other nights 8 p.m.
Hop 5649. Catalogues FREE.

**COMPLETE SET OF PARTS
for the Famous
S.T. 100 2-Valve Circuit**

as described in this Issue by
Mr. PERCY W. HARRIS.

Including 100,000-ohm Resistance with clips. Ebonite Panel with Rheostats, Valve holders and Terminals. Crystal Detector. 100 Volt. H.T. with plugs. 6 Volt. 40 A.H. Accumulator. 2 L. F. Transformers (specially suited for this circuit), 1 Dubilier Condenser .002, 1 ditto .0003, 2 Variable Condensers .0005.

Parts supplied separately if desired.

BEST QUALITY and BRITISH MANUFACTURE.

Price, including Packing, £6 : 15 : 0
If required 2 coils and coil holder, 17/6.
Cash with order.

BURNE-JONES & CO., LTD.,
Manufacturing Radio Engineers,
MONTFORD PLACE, KENNINGTON RD., LONDON, S.E.11
Phone: HOP 6257.

Experimental Stations (200 Metres)—
2.F.P. NEW CROSS
2.P.B. KENNINGTON
2.C.T. LAMBETH
6.C.W. STREATHAM

THE S. T. 100 CIRCUIT.

All components supplied to make up the model according to Mr. Percy Harris's article in this issue.

COMPLETE SET OF PARTS £4 - 0 - 0

Separate components as under :—

Baseboard	4/-
.0005 Condensers, in boxes	18/- each
Crystal Detector with crystal	5/- "
Valve Holders complete	1/3 "
Foster Transformers	21/- "
Terminals	1/5 dozen
Coil Blocks and Panels	1/9 each
Filament Resistances	3/6 "
100,000 ohms Resistance	4/6 "
Clips for Resistance	-/6 per pair
Dubilier Condenser .1002	3/- each
.0003	2/6 "

Write for full revised List No. 35.



15, Grape Street, Shaftesbury Avenue, W.C.
Telephone Regent 2636 & 2704.

BRANCHES:
15, Kingston Road, Wimbledon. Phone: Wimbledon 1030.
10, Station Road, Finsbury Park. " Hornsey ... 3373.
492, High Road, Chiswick, W. " Chiswick ... 2394.

Amateurs!

For 20 years the most beautiful work has been turned out by experimenters and model engineers possessing

DRUMMOND LATHES

The initial outlay is amply repaid—the pleasure obtained is endless.

Write for Lists.

They will show you the lathes in full detail; you will note the rigid construction, the modern design, the large capacity of these splendid tools. We illustrate above the 3½ in. lathe for treadle drive.

DRUMMOND BROS., LTD., Reid Hill, Guildford.

Post this Coupon.

Please send me lists of 4 in. and 3½ in. lathes, with details of deferred payment system.

(Send in unsealed envelope for 1d.)

NAME

ADDRESS

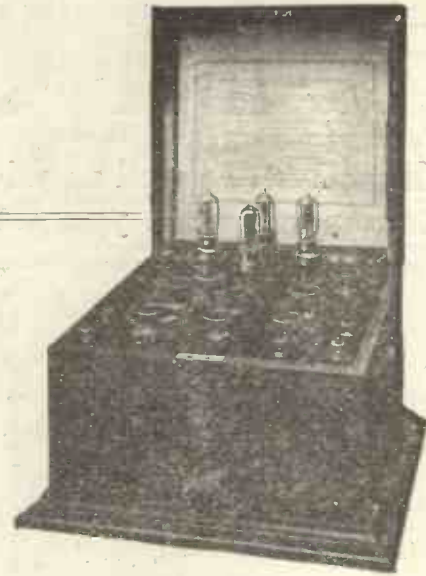
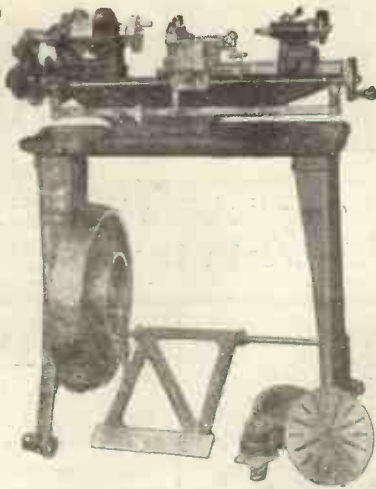

Reaction Sets

A THOROUGH investigation of the merits of the different makes of Broadcast Receiving Sets will quickly show that for performance the R.F.H. Reaction Sets (used under broadcasting licence) are unapproached.

A glance through the pages of any wireless paper will show that on the vital subject of range the majority of makers can only claim for a 2-valve broadcasting instrument a range of some 100 miles, while many are discreetly silent as to the range of reception.

On test at our Works, even a 2-valve reaction Broadcasting instrument receives perfectly from Königswusterhausen (630 miles), Paris (330 miles), The Hague (275 miles), London (110 miles), Newcastle (180 miles), and other British stations. These results are *telephony* and *not Morse signals*; they are received on a bona-fide 2-valve *without extra amplifiers*, and they are confirmed by letters which are pouring in every week from users in all parts of the country. The 3-valve and 4-valve sets are suitable for loud-speaker work.

These instruments are suitable for wave-lengths up to 3,000 metres. The reaction is contained in the instrument, and is variable over the whole of this wave-length range; there are no plug-in coils. They are guaranteed to tune-out a local broadcasting station even if only two or three miles away. Price of the 2-valve set complete with accessories (but without valves) with all B.B.C. royalties, etc., paid, is 25 guineas. 3-valve, 30 guineas. 4-valve, 35 guineas.

ROGERS, FOSTER & HOWELL, LTD.,
RADIO ENGINEERS.

EDWARD ROAD, BIRMINGHAM.

Telephone: No. 265.

Telegrams: "Autowire."

Your Aerial!

TAKE a little trouble with your Aerial and you will be amply repaid by the vastly superior results you will get.

Besides, a poorly erected Aerial is often a menace—it might collapse and cause serious damage. Better put up a good one while you are on the job.

Get a copy of this Book and read how easily a good one may be erected.

Radio Press, Ltd.,
Devereux Ct., Strand, W.C.2.

From all Booksellers and Newsagents, or 1/11 Post Free.

Radio Press Wireless Library No. 4.

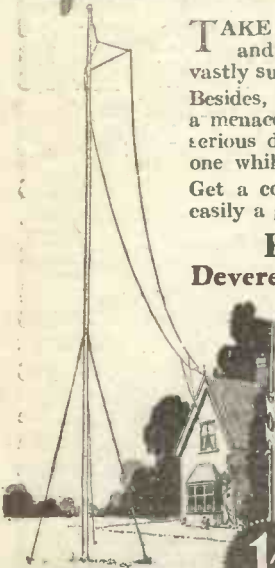

How to erect your Wireless Aerial

By B. Mittell, A.M.I.E.E.

1/-

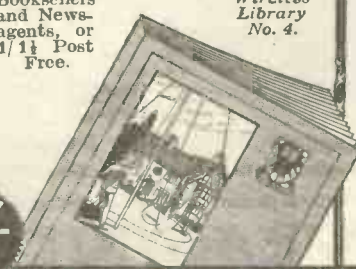

HULLO

Quality counts as well as price, something "cheap" and "nasty" is of no use to anyone. See you get an article worth the amount asked for it.

VARIABLE CONDENSERS

FIXED UP AS SHOWN.
(Drilled Ebonite Ends for same 1/- pair.)

Approx. Capacity in Mid.	PRICE.
·001	6/6
·0005	4/6
·0003	3/3
·0002	2/6
·0001	2/3
Vernier	1/9

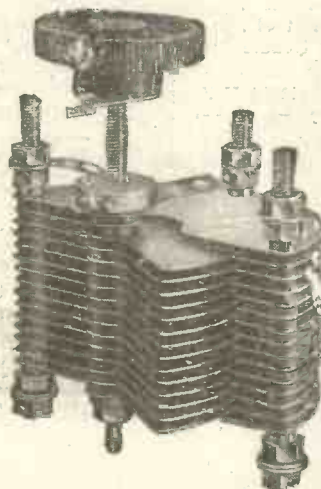

COMPLETELY ASSEMBLED AS SHOWN.

With ebonite ends and terminals.
Scale, 3d. extra.

·001 ...	8/-
·0005 ...	5/11
·0003 ...	4/11
·0002 ...	3/11
·0001 ...	3/6
Vernier ...	3/3



If required to be sent by post, the charge for post and packing is 1/3 per Set extra. Orders only accepted on this condition.

TRADE SUPPLIED,

NOT THROWN TOGETHER, BUT FIRST-CLASS GOODS.

ALL POST FREE

in this column.

ORDERS IN STRICT ROTATION.

- AERIAL WIRE, 7/22 100 ft. 3/9
- ALUMINIUM VANES 12 pairs 1/6
- Switch Arms ... 1/3, 1/6
- Filament Resistances, each 2/3, 2/-
- 7 ohms Filament Resistance, 4/-
- Valve Holders, moulded each 1/3
- Valve Holders, turned each 1/9
- EBONITE DIALS, 0-180 each 1/6
- INTERVALVE TRANSFORMERS (Radion Instruments, Ltd.), cannot be equalled ... each 26/-
- Voltmeters, 15 volt each 6/-
- Laminated Switch Blades, doz. 2/-
- Basket Coils, 6 in set each 3/6
- Twin Flex, 36 yds. ... 5/6
- Bell Wire, 12 yds. ... 1/-
- Glass Dustproof Detectors 4/3
- Green Egg Insulators doz. 3/6
- Knobs, 2 B.A. bush ... 3 for 1/3
- Scales, 0-180 ... 3 for 1/3
- TERMINALS, All Designs, Telephone, W.O., P.O., Fancy, etc., nuts and washers ... doz. 2/6
- Spacers, Large ... 3 doz. 9d.
- Small ... " 7d.
- H.T. Batteries, 60 volts ... 10/6
- Fixed Condensers, up to ·001 1/4
- Fixed Condensers, up to ·004 1/6
- Fixed Condensers ... ·005 2/-
- Fixed Condensers ... 006 2/6

Foreign Orders must be accompanied by extra postage in addition to above.

RIGHT OPPOSITE
DALY'S
GALLERY DOOR

M. RAYMOND
27, LISLE STREET, W.C.2.

Phone: Gerrard 4537
OPEN 9 to 8
Saturdays 9 to 6 p.m.
Sundays, 11 to 2.

EVERYBODY

Come along, Everybody. This is the place for the right goods at the right price. No rubbish offered.

PRICES TO CALLERS

(For post see special column).

- Accumulators charged .. 1/- to 1/6
- Aerial Earth & Phone Tabs, 3 for 2½d.
- Aerial Wire, bare copper 7/22, per 100 feet .. 2/4
- Aluminium Vanes .. 2 dozen 19d.
- Ball Joint each 1d.
- Basket Coils (6 in set) .. 2/8
- Bell Wire 1/20, good quality, doz. yds .. 8d. 110 yds. .. 4/6
- Bottom Bushes .. 9d. doz., each 1d.
- Condenser Bushes .. 9d. doz., each 1d.
- Contact Studs with Nut per doz. 6d.
- Copper Foil Sheet, 12in. by 3 in. each 3d.
- Crystal Cup, 4 screw, complete with screws .. 2 for 3d.
- Crystal Cup, 2 screws .. 2 for 2½d.
- Drilled ¼in. sq. Rod, 7in. 3d., 13in. 4d.
- Dutch Valves .. 8/- to 11/6
- Ebonite Dials with scale 0-180 10d. & 1/-
- Ebonite Dials with knob and scale 1/9 & 2/-
- Ebonite (turned) Valve Holders and 8 nuts .. 1/- & 1/3
- Filament Resistances, Extra quality 1/10, 2/3, 2/6
- Fixed Condensers, very good value, all capacities .. 11d.
- Grid Leaks 2 meg .. 1/-
- Inductance Coils each 1/6, 2/-, 2/6 & 3/-
- Insulators (Reel) .. 2 for 3½d.
- Interval Transformers, ratio 5-1 12/6, 14/- & 16/-
- Interval Transformers made by Radio Instruments, Ltd. .. 25/-
- Telephone Transformers made by Radio Instruments, Ltd. .. 20/-
- Lead-in Tubes and Brass Ends, 6in. 8d., 9in. 9d., 12in. .. 10d.
- Moulded Valve Holders, complete with nuts .. 11d.
- Moving Coil Holder, 1, 2, 3 way each 4/9 to 12/6
- Cossor Valves .. 15/-

PRICES TO CALLERS

(For post see special column).

- Nuts 2, 4, 5, 6 BA .. 3 dozen 6d.
- Phosphor Bronze Washers 3 for 1d.
- Polished Slider Knob and Plunger 3d.
- Rotax Accumulators, 4 v. 40 amps. 17/-
- Rubber Lead-in Wire, per dozen yards .. 1/3 to 1/9
- Scales 0-180 .. 3d. and 4d.
- Screwed Rod 2BA .. 12in. 3d.
- Screwed Rod 4BA .. 12in. 2½d.
- Spacer Washers, large, accurate, 3 doz. 6d.
- Spacer Washers, small, accurate 3 doz. 4d.
- Switch Arms, with bushes, knob, laminated arm, etc. .. 10d., 1/--1/8
- Switch Stops .. 2 for 1½d.
- Terminals, all kinds, W.O., Telephone, P.O., fancy designs, all good size and best quality, including nut and washer 2 for 3½d. per doz. 1/6
- Thousands of best quality bushed Knobs, with 2BA Nut at .. 3d.
- Valve Holders, turned ebonite, 8 nuts .. 1/3
- Valve Leg with nut .. each 1d.
- Variometer, with dial and knob 4/11 to 7/6
- Perikon Crystal Detectors, with two crystals .. 2/4 to 3/3
- Glass Dustproof .. 2/6 to 3/9
- Upright Dustproof .. 1/9 to 2/3
- 1000 Detectors at .. 1/- to 1/6
- Crystal Detector parts with cup and whisker .. 9d.
- Wound Formers, 12 by 4 .. 2/8
- Valve Pins .. doz. 7d.
- Stop Pins with shoulder .. doz. 5d.
- Shellac, large bottles .. 7d.
- Brass Washers, 4BA. 2BA 3 doz. 3d.

SPECIAL BARGAIN LIST.

No Post Orders at these Prices.

- ACCUMULATORS (The Best!), 4 v. 60 a., 18/11; 6 v. 60 a. .. 27/6
- Basket Coils, set of 6 .. 2/4
- Boxes, mahogany, 7 by 5 .. 3/3
- Green Egg Insulators (best Danish), doz. .. 1/9
- Hard Drawn 7/22 Aerial Wire, 100 ft. .. 2/4
- H.T. BATTERIES (The Goods!), 66 v., 9/-; 60 v., 8/6; 36 v., 4/6; 30 v., 4/6
- Phones, 6,000 ohms, fine value .. 19/6
- Pure Copper 7/22 Aerial Wire, 100 ft. .. 2/1½
- Sistoflex, 2 m/m, takes 18 gauge wire .. 3 yds. .. 1/1
- Switch Arm, with 12 studs and nuts, the lot .. 1/2
- Twin Flex, good quality, 12 yds. .. 1/7
- Variometers, W.L. 700, with knob (If Dial required, 9d. extra.) 3/9
- Voltmeters, 15-volt .. 5/-
- Wonderful Wound Coils, perfect finish—12 by 4, Turns 500, W.L. 3800 .. 2/8
- 9 by 3, Turns 300, W.L. 2750 .. 2/4

HEADPHONES.

(Postage 1/6 pair extra.)

- Brunet, genuine, 4,000 ohms. .. 21/6
- Ericsson, E. V., supplied to Marconi's, stamped B.B.C. (while they last) 15/-
- French Phones, very good value, 4,000 ohms .. 14/6
- Sipde, genuine, 4,000 ohms. (while they last) .. 15/11
- T.M.C., genuine, removed from sets to clear, B.B.C., 4,000 ohms. .. 24/6

Beware of Rubbish got up to look like Wireless Parts.

TO CALLERS!

I sell everything you want for your home-made Sets. No junk. No cheap Job lines. All low in price, but first-class quality.

Trade Supplied.

ALWAYS BARGAINS IN THE WINDOWS

TESTIMONIAL. 3/5/23

The Stratford-on-Avon and District Radio Society.

Dear Sir,
The Condensers to hand and many thanks for prompt despatch. I consider condensers are good value for money. You shall have further orders from this Society.
Yours faithfully,
E. W. Knight, Hon. Sec.

RIGHT OPPOSITE
DALY'S
GALLERY DOOR

M. RAYMOND
27, LISLE STREET, W.C.2

Phone: Gerrard 4637
OPEN 9 to 8
Saturdays 9 to 6 p.m.
Sundays, 11 to 2.



Contents

	Page
Editorial	397
The "ST 100" Receiver for the Beginner	399
By PERCY W. HARRIS.	
Two-Valve Circuits	404
By JOHN SCOTT-TAGGART, F.Inst.P.	
Regular Programmes from Continental Broadcasting Stations...	410
In Passing	411
A Simple Crystal Receiver	413
By E. H. CHAPMAN, M.A., D.Sc.	
The Photophone	415
By Prof. A. O. RANKINE, O.B.E., D.Sc.	
Positive and Negative	421
What Others Think	422
Experiments with the "ST 100" Circuit	425
By JOHN SCOTT-TAGGART, F.Inst.P.	
The Experimental Station 2 DX	428
By W. K. ALFORD.	
A Link in the Imperial Chain	430
A Portable Broadcast Receiver	431
By G. P. KENDALL, B.Sc.	
Some Experiments with Aerials and Earths	437
By PERCY W. HARRIS.	
Summer Radio	440
"Directional Wireless"	442
By J. ROBINSON, M.B.E., Ph.D., M.Sc., F.R.Met.Soc.	
Above and Below the Broadcast Wavelengths	446
By LAMBDA.	
Crystal Points	448
The Measurement of Wireless Quantities	450
By E. H. CHAPMAN, M.A., D.Sc., F.R.Met.Soc.	
A Simple Long Wave Set	454
By PAUL WOODWARD.	
An Easily-made Wave Meter for 300 to 9,000 metres	457
By H. C. EXELL, B.Sc.	
Types of Tuning Inductance	459
By R. W. HALLOWS, M.A.	
The "Crypto" Commutating Rectifier	463
A Glossary of Technical Terms used in Wireless Telegraphy and Telephony	464
How to Choose a Honeycomb Coil	465
Practical Notes	466
Tested by Ourselves	475
Information Department	477
"Modern Wireless" Free Template Page	xxx

Editor:
JOHN SCOTT TAGGART,
 F.Inst.P.

Assistant Editor:
 E. REDPATH.

Staff Editors:
J. H. T. ROBERTS
 D.Sc., F.Inst.P.
 E. H. CHAPMAN,
 M.A., D.Sc.
 A. D. COWPER, M.Sc.
 G. P. KENDALL, B.Sc.
 A. L. M. DOUGLAS.
R. W. HALLOWS, M.A.
 S. G. RATTEE.
 PERCY W. HARRIS.

Scientific Adviser:
 Prof. G. W. O. HOWE,
 D.Sc., M.I.E.E.

Advisory Editors:
 Prof. R. WHIDDINGTON,
 M.A., D.Sc.

Prof. C. L. FORTESCUE,
 M.A., M.I.E.E.
 Tel.—Central 4393.

Advertisement Managers:
 SCHEFF PUBLICITY
 ORGANISATION, LTD.
 125, Pall Mall, London,
 S.W. 1
 Tel.—Regent 2440.

MODERN WIRELESS

Radio Press Ltd
 PUBLISHERS OF WIRELESS WEEKLY
DEVEREUX COURT.
 • STRAND.W.C.2 •

All correspondence relating
 to contributions is to be
 addressed to the Editor of
 "Modern Wireless."

Nothing contained herein
 is to be regarded as per-
 mission or encouragement
 to infringe any patent
 rights.



RECENT letters in the *Times* and elsewhere clearly indicate that the public is beginning to be dissatisfied with the lack of selectivity in wireless apparatus now sold for broadcast reception. This is particularly the case in sea-board towns where interference from ship stations is particularly marked. Indeed, some readers go so far as to express the opinion that these stations should be made to work on some other wave-length than that which may happen to interfere with broadcasting generally. Such a request is bound to raise a smile amongst those who are acquainted with the paramount importance of nautical wireless, but no good purpose will be served by ignoring this public demand for better selectivity, and its relation to wireless signals received from coast stations and ships at sea.

* * *

As will be seen by reference to any current broadcasting programme, the wave-lengths used for British broadcasting range from 353 metres (Cardiff) to 425 metres (Birmingham). Most ship work is carried out on a wave length of 600 metres, but a considerable proportion is carried out on 300 metres, and the direction-finding work, which is of great importance to navigation, has allotted to it a wave-length of 450 metres. The Midland Railway boats running from Heysham Harbour to Ireland and certain vessels plying between Great Britain and the Continent use a wave-length very close to those adopted by

some of the broadcasting stations, and it is probable that the bulk of the interference complained of comes, not from the normal 600 metre working, but from the shorter waves used.

* * *

Sharpness of tuning is dependent, not only on the receiving apparatus, but upon the transmitting station itself. Further, if we are situated in the immediate vicinity of a transmitting station it will be much more difficult to tune it out when listening to a station on another wave-length than it would be if the interfering station were many miles away. For this reason people listening to the concerts in coastal towns can be interfered with by ships working on a wave-length quite different from that on which broadcasting is being received.

* * *

There is a great difference between various types of ship installations in the interference they can cause on wave-lengths other than their own. The best modern apparatus is quite sharply tuned and should not cause interference more than a few miles away. There is, of course, no excuse for ships working on wave-lengths other than those allotted to them, and we have recently heard of many cases where ships have been working on wave-lengths many meters above or below their normal. Some of the foreign ships and coast stations are particularly bad offenders.

Salvation for the listener-in who is interfered with in this way will mainly come by his obtaining greater selectivity in his own apparatus. In the wise endeavour to popularise their apparatus, many manufacturers have, perhaps, over-emphasised the point of simplicity, and in endeavouring to turn out what we may term "one handle" apparatus (all adjustments being made on one knob or dial) they have had to sacrifice the very selectivity which might rid the listener-in of all his troubles. Many people are inclined to think that manufacturers do not credit the purchasers of their apparatus with sufficient intelligence, as most people can easily learn to handle, say, a two-circuit tuner with its greater selectivity. In America, where the problem of interference is really far more serious than is generally realised by listeners-in in this country, the single circuit type of tuner, which is practically universally used here, is rapidly passing out of favour, and sets with two or three tuned circuits, giving, of course, greater complication of control, are found in the homes of most discriminating listeners-in.

* * *

In the early days of motoring some manufacturers attempted to place on the market motor-cycles and motor-cars in which all refinements of adjustments were sacrificed in order to obtain a similar "one-handle" simplicity. The motor-cycles and cars so made were never popular, as practically every motorist likes to feel that he is expressing his individuality in the various adjustments. We would, therefore, counsel manufacturers not to be unduly frightened of marketing apparatus in which selectivity is obtainable by sacrificing a little simplicity, for we must credit the average man with a reasonable intelligence, and when the uses of two or three controls are made clear to him it is much more likely that he will be prepared to pay a little more for the advantages thus obtained.

* * *

There is room for a great deal of research for obtaining selectivity in broadcast receivers, as even the best are unable to tune out the local broadcasting station if it is situated within four or five miles. In this connection we would like to point out that interference from the local station is considerably influenced by the size of the receiving aerial. Very high aerials are particularly susceptible to the waves from local stations, and frequently

it will be found that a long low aerial will give satisfactory signals from a distant station when cutting out the local broadcasting concerts, while an aerial twice the height and shorter in horizontal length will give very little better results from the distant station, but considerably greater local jamming.

* * *

We are deeply grateful to the readers of this magazine for their magnificent response to our invitation of criticisms. Notwithstanding that, owing to an unfortunate printer's error, the questions form was printed on the back of valuable editorial matter, and not, as planned, on the back of an advertisement, many hundreds of replies have been received, some of the forms being accompanied by long letters in which our readers have expressed their views in considerable detail. It is only by the intimate contact with our readers obtainable in this way that we can make MODERN WIRELESS what we aim to make it—the best wireless magazine in the world. We find on analysis of replies that the great majority of our readers express indifference regarding the paper the magazine is printed upon, provided the reading matter maintains its present standard. As, however, we aim to make fuller use of photographic illustrations, as will be seen from this number, it has been decided to adopt a higher grade of paper on which the greater proportion of this issue is printed.

* * *

Almost every form has contained a note of appreciation which has clearly indicated that MODERN WIRELESS is giving its readers the kind of magazine they wish to have. Future issues will reflect our readers' wishes, and we shall push steadily forward towards the goal we have set ourselves—the attainment of the ideal in radio magazines.

* * *

Many readers have expressed the opinion that it would be better to place the advertisements in a section by themselves rather than interleave some of them with the reading matter. We would point out that the advertisements in MODERN WIRELESS are so arranged that they can be removed without injuring the copies when they are bound, for advertisements are backed by advertisements and it is quite a simple matter for the binder to lift out these sheets when reassembling the copies for binding.

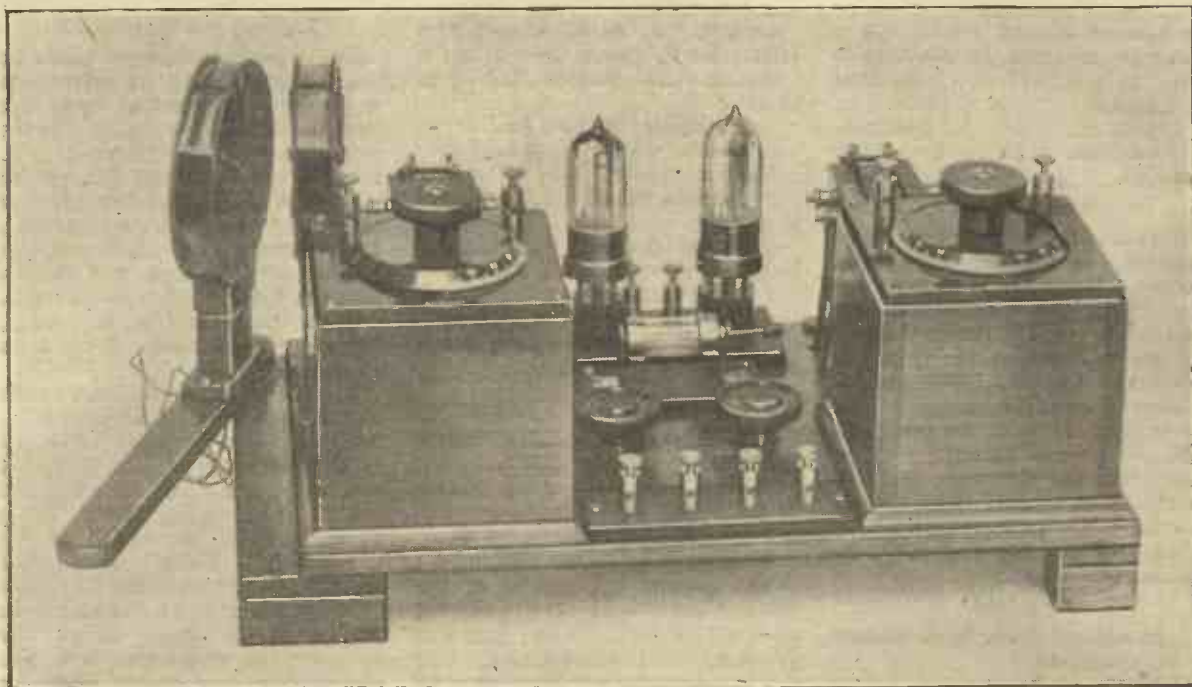

The neat "ST 100" set described in this article.

THE "ST 100" RECEIVER FOR THE BEGINNER A Simple and Efficient Design that all can Make

By PERCY W. HARRIS, Staff Editor.

In the June issue of MODERN WIRELESS Mr. John Scott-Taggart described the highly efficient dual-amplification circuit to which the name "ST 100" has been given. In his article sufficient data were supplied to enable the experimenter to build up the circuit and try it out for himself, with the result that large numbers of readers have written in to express appreciation of the wonderful results obtained. In this article—the first contributed by Mr. Percy W. Harris to this magazine—the new circuit is built into a very neat design, and the fullest possible constructional details are given, so that any reader—even if he has yet to make his first instrument—will be able to start work immediately on completing the perusal of the description.

WIRELESS ceases to be a selfish amusement when all around can listen, but this desirable ideal is not particularly easy of achievement. We really have two alternatives: on the one hand we can provide a sufficient number of headsets, and on the other we can invest in a loud speaker with its attendant amplifier. There are drawbacks to both methods. If we buy enough telephones (and "enough" generally turns out to be one pair less than the number of guests who want to listen) it is a frightfully expensive business; while if a loud speaker is installed, it generally means a multi-valve set to run it. As many know by painful experience, the man who installs a broadcast

receiver which gives good results with two valves has been accustomed to find that if he wants to run a loud speaker two more valves are needed. And here the wife steps in and says that quite enough has been spent on the set already and she wants a new hat.

The reader is probably wondering what all this has to do with the "ST 100" circuit; but this little preamble is necessary to explain why the device has already achieved such a wonderful popularity. It is largely because a two-valve set built to this design is quite powerful enough for, and is so admirably suited to, loud-speaker work, and because it can be built so inexpensively, that the more experienced experimenters all

over the country are building it in hundreds.

The Question of Expense

Take, for example, the instrument described in this article. To build it represents but a few evenings' work. If we exclude the cost of two valves and their batteries, as these are already in the hands of many beginners who have experimenters' licences, the whole of it can be built with first quality components for less than £7 10s., and if to this we add £6 2s. 6d. for a really good quality loud speaker the outlay is well under £14, which cannot in any way be called an extravagance. And if the reader is under the impression that a loud-speaker equip-

ment must always sound like a cheap gramophone, he has only to listen to the "ST 100" working an Amplion, Claritone, Magnavox, or any of the good loud speakers, to have this impression speedily removed.

Components

Here is a list of the components required. Be sure they are of good quality. Don't buy cheap unnamed intervalve transformers and then write to Mr. Scott-Taggart and me to say that the circuit is no good. In this instrument it is more than ever essential that the component parts be free from fault, as several have to perform more than one function, and the imperfections will be doubly magnified. Cheap components have a habit of turning out very expensive.

Required

A baseboard made in a manner to be described.

Quantity of brass wood screws known as Nr. 4's, $\frac{3}{8}$ in. long, with round heads.

A few brass wood screws Nr. 6's, $\frac{1}{2}$ in. long, with countersunk heads.

4 wood screws, $1\frac{1}{4}$ in. long.
4 yards insulating tubing.

Quantity of tinned copper wire (about Nr. 22 gauge) for wiring up. Ebonite as follows (all $\frac{1}{4}$ in. thick):

- 1 strip, $4\frac{1}{2}$ in. by $1\frac{1}{4}$ in.
- 1 strip, $4\frac{1}{2}$ in. by $2\frac{1}{4}$ in.
- 2 strips, 2 in. by $\frac{3}{4}$ in.
- 2 filament resistances for panel mounting.
- 1 crystal detector complete on base (preferably enclosed).
- 2 valve sockets.
- 2 good intervalve transformers.
- 2 variable condensers .0005 microfarad each (in boxes).
- 10 terminals.
- 2 coil sockets.
- 1 fixed condenser .002 microfarad.
- 1 fixed condenser .0003 microfarad.
- 1 resistance of 100,000 ohms.
- Plug-in coils, to be described.

The general appearance of the finished instrument will be gathered from the photographs and diagrams which accompany this article. The design has purposely been made as economical as possible consistent with the highest efficiency, and for this reason ebonite is only used where it is necessary—a point, by the way, which accounts for many shillings saving.

Making the Baseboard

Our first consideration must be the baseboard, and its actual size is somewhat dependent upon the component parts purchased. In the writer's instrument it measures 15 in. by $8\frac{1}{2}$ in. by $\frac{3}{8}$ in. thick; $\frac{3}{8}$ in. planed wood, of this width, is obtainable at any timber yard at a very low cost, and ordinary deal when properly finished off with stain and varnish presents quite a good appearance. Oak or mahogany is, of course, better, but naturally much more expensive.

First of all cut off a piece of such length that it will take your components, when arranged as shown in the photographs, and then cut two strips, one $2\frac{1}{4}$ in. wide and the other $1\frac{1}{4}$ in. wide, both being $8\frac{1}{2}$ in. long (or the width of the baseboard). These should be secured to the ends of the underside of the baseboard with glue and three screws each. These strips are necessary as stiffeners. You will also require four corner pieces of the shapes shown to raise the whole instrument above the table so as to allow of room for the components mounted on the underside, and the wiring. These corner pieces should be not less than 1 in. thick, and are

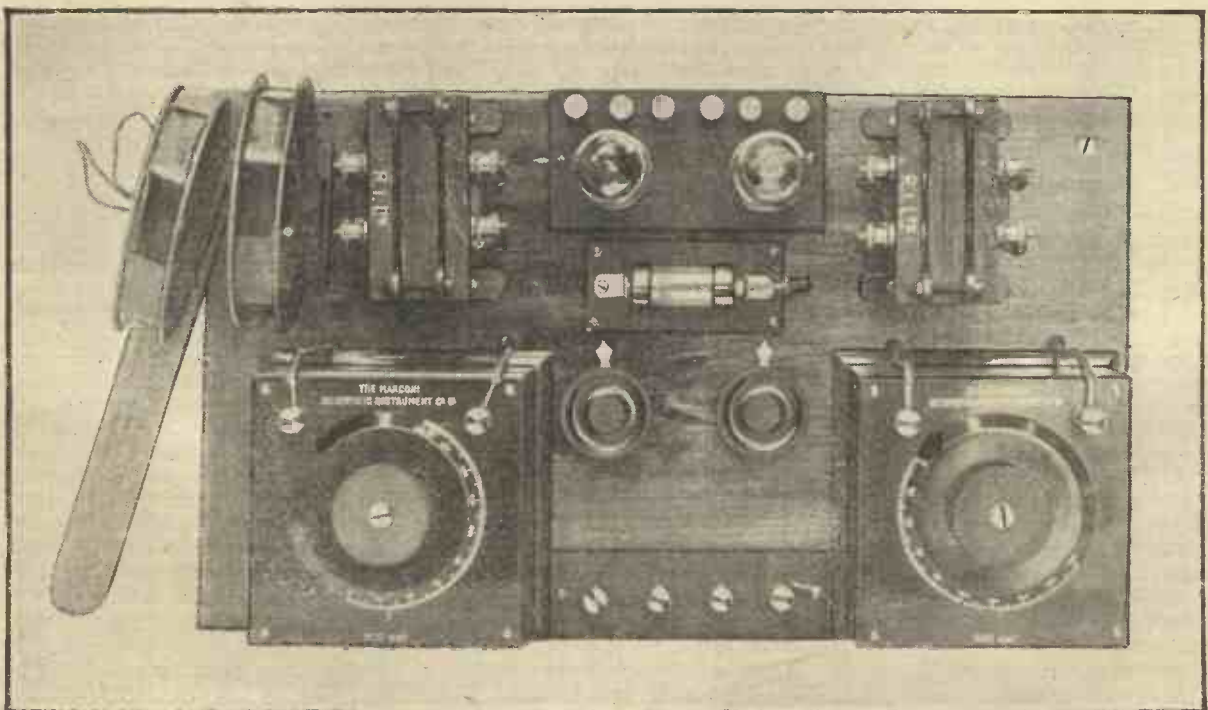

A top view of the finished instrument showing the disposition of parts.

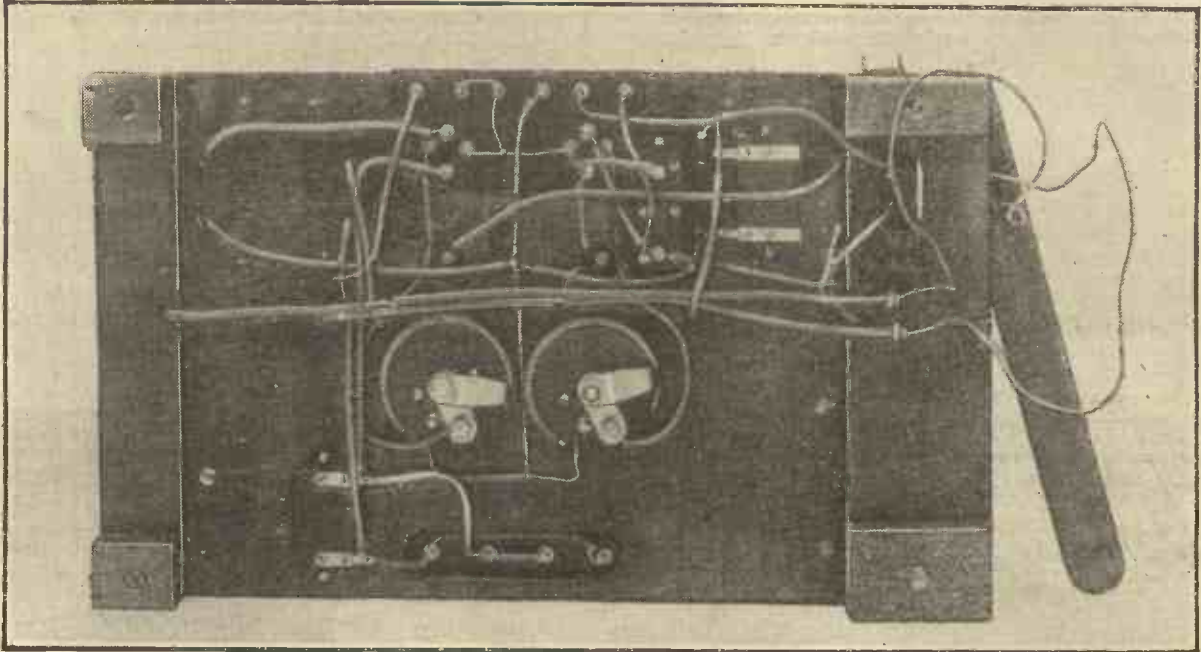

A photograph of the underside of the baseboard.

secured by the four $1\frac{1}{4}$ in. wood screws mentioned in the components list.

It will be noticed that the wider strip is mounted so as to project about 1 in. from the left side of the baseboard. This is so that it will carry the swinging reaction arm at the right level. This arm is simply a strip of wood about 1 in. wide and as long as the baseboard will allow, and is mounted by a single countersunk-head screw. Both ends should be rounded as shown, one from necessity to allow movement and the other for convenience in handling.

When this work has been done the whole board should be carefully smoothed off with sandpaper or emery cloth, and given two coats of varnish stain of whatever colour pleases the fancy of the builder. It can then be drying while you make the other parts. Don't forget to stain the underside, as all your friends will be turning it over to look at the wiring!

Ebonite

Now cut the ebonite pieces, and then remove the surface shine by rubbing them with fine emery cloth. This is necessary, as the surface of ebonite is frequently covered with a semi-conducting skin which ruins the insulating properties of the substance. All the ebonite drilling

can be done with a No. 27 Morse drill, which will bore a clearance hole for a 4 BA metal screw where needed. Notice that in addition to the holes for mounting the components you must also drill holes for securing the strips to the baseboard. If you have any trouble in locating the positions for the valve legs, you will find a free template at the end of this issue. The holes for the terminals on the front strip can be 1 in. apart, and those on the back panel $\frac{3}{4}$ in. apart, although slight variations of these spacings will not matter much.

You will probably have purchased the crystal detector complete on an ebonite base, but if it is not so fitted it must be mounted on a strip of suitable size.

A Plug Socket Tip

The mounting of the plug sockets may give a little trouble with some kind of socket, but if you obtain the pattern supplied by Burndept, Ltd., you will find it quite easy, as these have two 6 BA metal screws passing through their base. These can be unscrewed, and if two holes are drilled in the ebonite strips at the same separation, the same screws (or two a little longer) can be passed through and will then secure the plug firmly to the strip. Connec-

tions can be soldered to the underside. The Igranite type of plug socket may need to be drilled and tapped, which is a little troublesome to the beginner. Why on earth no manufacturer has been enterprising enough to market properly mounted sockets for instrument boards passes my comprehension. *Verb. sap.*, let us hope.

When all the strips have been drilled and the parts mounted on them, we must cut the baseboard so that the terminals do not touch wood anywhere. It will be found very useful to invest in a $\frac{3}{4}$ in. wood boring bit, which is just the right size to make a hole where a terminal will fall. The diagrams on the next two pages show what to do in cutting out. Care must be taken not to split the thin wood when cutting. As the swinging reaction arm rubs on the projecting wood strip, two grooves must be made on the underside to allow clearance for the flexible leads.

Mounting

Now set your components in place and drill the necessary holes to allow the wiring to pass through the baseboard, and then mount the parts as shown. All parts can be mounted with the round-headed screws. Before fixing the panels in place file the ends of all terminals to be soldered with a fine file so

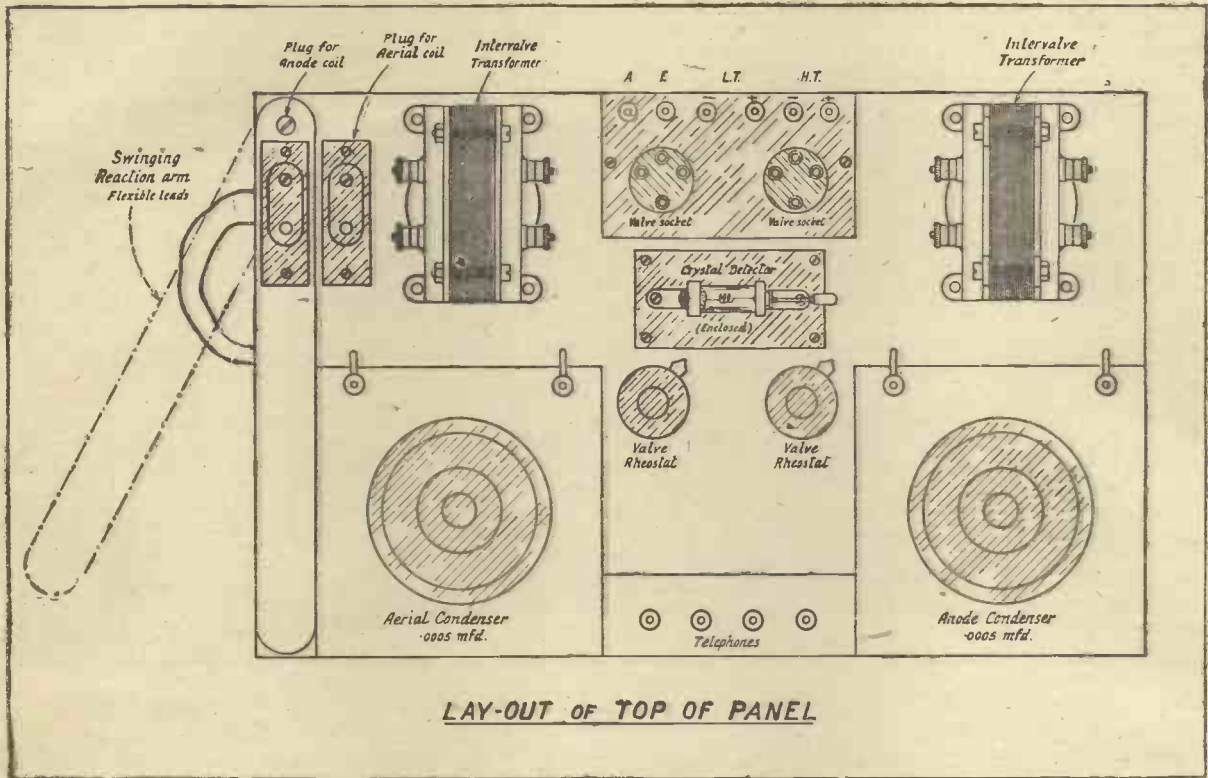

LAY-OUT OF TOP OF PANEL

as to present a bright surface to which the solder will adhere properly. It will be convenient to solder the flexible leads to the plug socket before mounting it on the swinging arm. A single screw will serve to hold the arm in place and act as a pivot; but a washer should be placed on the underside so that the swinging motion is quite smooth.

When soldering use but the slightest touch of soldering paste, for if this substance melts and runs over the ebonite it will form a highly injurious conducting layer which may take away your signals altogether. Use a hot, clean soldering bolt, and, if you can, heat it in a clean flame, such as that of a gas ring. Use only sufficient solder to make a good joint, and after all soldering is finished be sure to tighten up the various locknuts which will have been loosened by the heat. When soldering, fix a goldwire catwhisker in place of that fitted when you bought the detector, as this wire will give you better results and greater constancy of adjustment. As to crystals, I find Hertzite works very well in this circuit. Zincite-Bornite, I am told, is also a good combination in this receiver.

Coils Needed

A point where the constructor may go wrong is in the spacing between the fixed and moving sockets. This is dependent upon the size of the coils you are going to use. The writer uses two Gambrell inductances in this receiver, the coils marked A and B just nicely covering the broadcast band. A Burndept No. 2 and No. 4 of the concert series does the same, but wider separation is needed. Igranic 25 and 50 also serve well. The smaller coil is always in the fixed socket.

In Mr. Scott-Taggart's article last month the aerial condenser was shown in series or in parallel. The writer finds it best in parallel, even with a fairly large aerial, and it is so wired in the instrument being described.

On the underside of the board are mounted the 100,000 ohm resistance (in this case made by the Marconi Scientific Instrument Company, Ltd.) and the two Dubilier fixed condensers. Other makes of condensers and resistances would of course do if the values were right. Attention is particularly drawn to the fact that in several cases wires cross and join, and where this happens a black dot is shown.

In other places they do not join at the crossing. In the diagram of the underside the holes through which the wires pass are marked to show to what they are connected on the other side. The flexible leads connected to the plug socket on the swinging arm are simply pieces of electric lighting flex and are soldered to stiffer wire on the underside. To prevent the stiff wire moving about, it is secured to the baseboard at the point of joining the flexible leads with two staples.

I have not given any details for the mounting of the filament resistances, as these are made in so many different patterns that it would be useless to do so.

The insulating tubing should be pushed on when one end of each wire has been secured, and should be carefully measured so that as little wire as possible is left bare.

First Tests

You will now come to the most fascinating part of all—the first test. If you have made the instrument according to the instructions given here, you will find all is well. Test first of all on your nearest broadcasting station (this instrument is most efficient when the signals are fairly strong), and

before tuning place the catwhisker in contact with the crystal. Both condensers will need to be varied, and when you notice signals from the station you want to hear, adjust both condensers to give the best results. Next note the best position for both condensers, and then deliberately detune until signals are weak. Now adjust the crystal until the signals are as good as you can get them, and finally return to the best settings of the condensers, when you will hear the speech and music in tremendous strength for two valves, and of a purity which will probably be much better than you have ever heard before on a valve set.

If you are used to handling a tuned anode receiver, you will find that the coils needed for any particular

wave-length are the same as in your own aerial and anode circuits.

Reaction and its Use

This set is fitted with variable reaction; but, of course, this must not be used on broadcast wave-lengths, in compliance with the ruling of the Postmaster-General, and in consideration for other listeners-in. As a matter of fact, the reaction, while increasing the strength of signals, does not increase them to as large an extent as in some other instruments, so you do not lose much sensitivity by refraining from using it. It is, of course, an advantage when receiving "Radiola" and other longer wave stations from a great distance.

The set described in this article, unlike many dual-amplification sets,

is very stable, and is quite as easy to handle as the more common tuned-anode sets. The luxuriously inclined will find it very easy to mount the set on an ebonite panel with the condensers below and with a two-coil holder on the side of the box, as the wiring will be just the same. To assist those who find the wiring up the most difficult part of all, a full size blue print of the diagram on this page will be sent to any reader post free on receipt of 1s. 6d. The set can then be wired up with the blue print alongside, and without any risk of spoiling this copy of the magazine by too constant handling.

MODERN WIRELESS will be very pleased to hear from readers who successfully construct the set from this article.

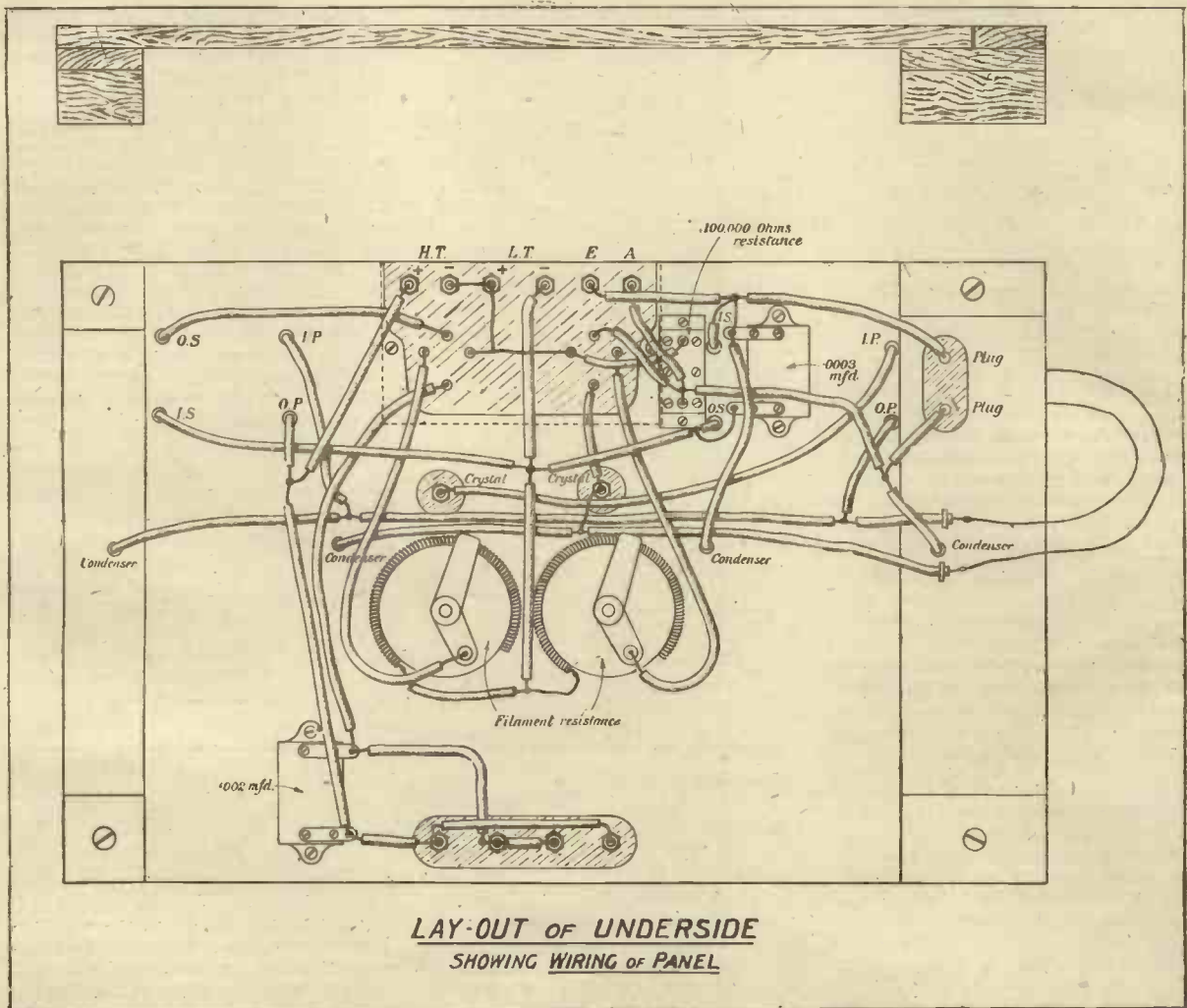

TWO-VALVE CIRCUITS

Their Arrangement and Operation

By JOHN SCOTT-TAGGART, F.Inst.P.

This article gives particulars of numerous two-valve circuits, together with instructions for operating them.

THERE are probably more experimenters in the two-valve class than any other. When more than two valves are used, the expense, in many cases, becomes ap-

preciable and often greater skill is required in handling the apparatus. I have previously discussed the use of crystals in conjunction with valves, and it is therefore proposed to omit crystal combinations in the circuits which follow. These circuits are all of a practical nature and may be used with confidence. In some cases, one type of circuit will be used, whereas under different conditions perhaps another one is to be recommended.

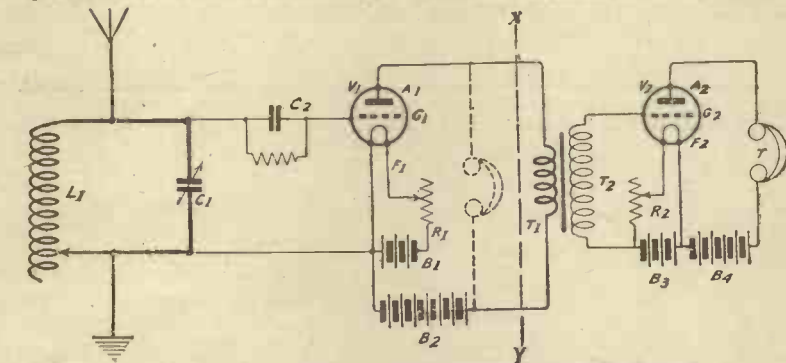

Fig. 1. Theoretical detector and note magnifier circuit.

Where the signals are initially strong, the circuit shown in Fig. 2 may be used, and will be found to give no trouble whatever. There is only one adjustment, namely the condenser C_1 , and perhaps the inductance L_1 . This circuit is built up from the theoretical arrangement shown in Fig. 1. In this figure, to the left of the dotted line X Y, we have a simple detector valve V_1 . The aerial circuit, which includes the variable inductance L_1 and the variable condenser C_1 , is connected across the grid and filament of the valve V_1 . In the grid circuit we have the grid condenser C_2 , having a capacity of $0.00025 \mu\text{F}$. or $0.0003 \mu\text{F}$. shunted by a resistance having a value of about 1.5 or 2 megohms. It will be seen that the connection from the earth

lead is taken to the positive terminal of the filament accumulator B_1 . The leaky grid condenser C_2 is for the purpose of rectifying the high-frequency oscillations, and in some cases

lead is taken to the positive terminal of the filament accumulator B_1 . The leaky grid condenser C_2 is for the purpose of rectifying the high-frequency oscillations, and in some cases

X Y. This portion consists of a low-frequency amplifying valve V_2 . A step-up intervalve transformer $T_1 T_2$ has its primary winding T_1 connected where the telephones would ordinarily go, these latter, of course, being now taken out of the anode circuit of the valve V_1 .

The secondary winding T_2 is connected across the grid G_2 and filament F_2 of the second valve V_2 . In the anode circuit of this valve we have the high-tension battery B_3 and the telephones T. As this is not a practical arrangement, we dispense with the additional accumulator and high-tension battery, and rearrange the circuit as in Fig. 2. There are two points which might be mentioned with regard to the Fig. 2 circuit. One is that the left-hand side of the winding T_2 is connected to the negative terminal of the accumulator, the rheostats R_1 and R_2 being connected in the lead to the negative electrode in the lead to the negative terminal of the filament accumulator. The purpose of this is to give the grid of the second valve a slight negative

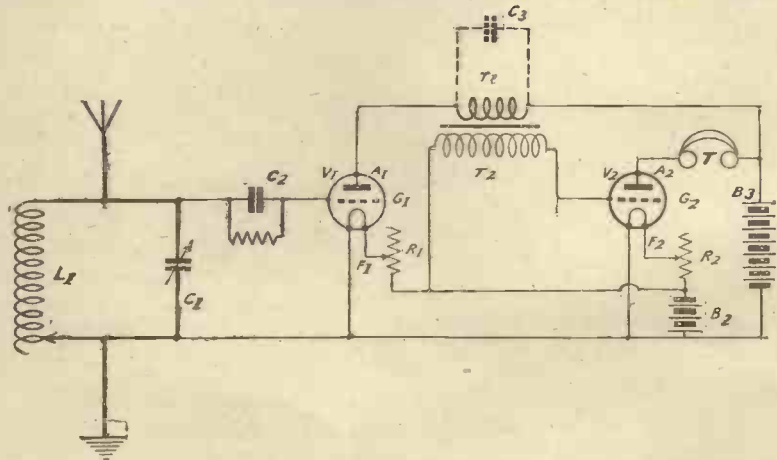

Fig. 2. The same circuit made practical.

better results. In the anode circuit of the valve we would normally have the telephones T, but to enable us to obtain stronger signals we now add the portion to the right of the line

potential with respect to the negative end of the filament, this negative potential being caused by the drop of voltage across the rheostat R_1 .

The other point to mention is the

condenser C_3 connected across the primary winding T_1 of the step-up transformer $T_1 T_2$. This condenser C_3 has a value of $0.002 \mu\text{F}$, but in many cases it serves no useful purpose and may be omitted.

The results obtainable with the circuit of Fig. 2 are very ordinary, but on the other hand, the circuit is extremely reliable, the adjustments are a minimum, and the set will never oscillate.

Use of Reaction

The circuit of Fig. 2 may be easily modified so as to give very much louder signals. This modification consists in including an inductance coil in the anode circuit of the first valve, and coupling this coil to the inductance in the grid circuit.

Fig. 3 shows a theoretical arrangement in which the function of the two valves is kept separate. The first valve carries out two functions. In the first place it acts as a detector, as in Fig. 1, and in the second place the valve is used as a means of introducing reaction into the aerial circuit. This reaction boosts up the signal strength in the aerial circuit, as explained in No. 3 of MODERN WIRELESS. It is important, of course, to see that the leads to the coil L_2 are the right way round. When using honeycomb coils it is not sufficient merely to reverse the coil in its holder. As the inductance coil L_2 is brought closer up to L_1 , the signal strength should be greater after a slight readjustment of the condenser C_1 . The mere fact that there is no increase in signal strength as the result of bringing L_2 closer to L_1 , is no indication that reaction has not been introduced. The variation of reaction is nearly always accompanied by a change in the wave-length of the circuit into

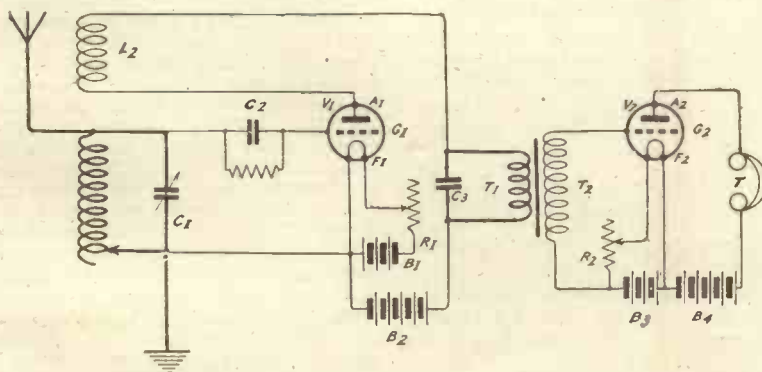

Fig. 3. Theoretical circuit with reaction added.

which reaction is introduced. It will be found that in nearly all cases the capacity of the condenser C_1 has to be increased slightly. Whenever the reaction is adjusted, a slight readjustment should be effected.

It may seem at first strange how there could be two sets of current

variations in the anode circuit of the valve V_1 . We have the high-frequency currents in the anode circuit, and at the same time we have low-frequency current variations, due to the variations of grid potential produced by the rectifying action of the leaky grid condenser. In "Wireless Valves Simply Explained," I give an analogy which ought to help students. If we have an ammeter through which

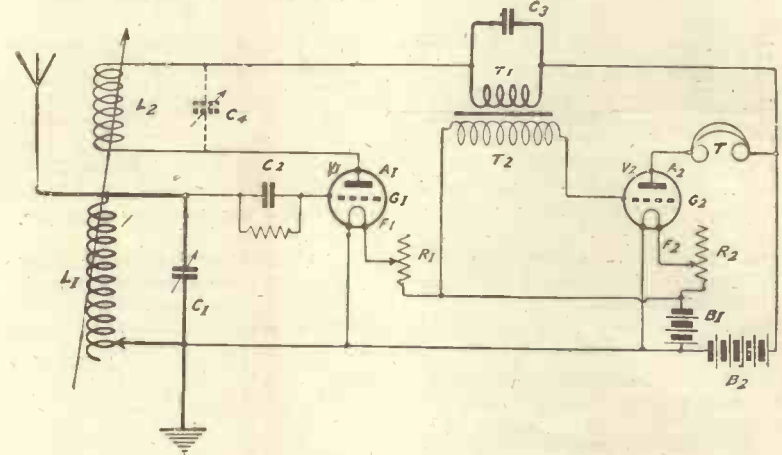

Fig. 4. Previous figure made practical.

a steady current of, say, 2 amperes is passing, and we now send through this ammeter a feeble alternating current having a maximum amplitude of 1/10th of an ampere, the needle of the ammeter, although normally at 2 amperes, will flicker above and below this value. If now we vary the steady current through the ammeter without varying the alternating current, the needle may move down to, say, 1 ampere, but the flickering still continues. We can, in fact, vary the steady direct current up and down at

an iron core, of course, the position would be different.

As regards the winding T_1 of the step-up transformer $T_1 T_2$, which is used for passing the low-frequency currents on to the valve V_2 for amplification, this transformer winding does not pass high-frequency currents because the impedance offered to the high-frequency currents is so great that the latter prefer to go through the condenser C_3 , which acts as a short circuit, as it were. The high-frequency currents differ from low-frequency ones in that they pass through a condenser very readily, and, in fact, prefer to pass through a coil of very large number of turns, such as T_1 .

The condenser C_3 is called a by-path condenser, and usually has a capacity of $0.002 \mu\text{F}$ microfarad. This condenser is recommended in practically all circuits where there is a useful high-frequency current flowing in the anode circuit of the valve. This high-frequency current, in the present case, in no way interferes with the transfer of the low-frequency currents to the second valve, the anode circuit of which contains the telephone receivers.

Fig. 4 shows the practical form which the Fig. 3 circuit takes. There are now no separate batteries. The condenser C_3 is sometimes omitted, but this is not to be recommended as general practice. When it is omitted and reaction can still be obtained, this is due to the self-capacity of the winding, T_1 , the high frequency currents

a low-frequency without altering the flickering effect which takes place all the time. In the case of the valve V_1 of Fig. 3, the grid G_1 becomes negative at low-frequency intervals, and this produces decreases of similar frequency in the anode current. While these decreases are taking place

stepping across, as it were, the small condenser formed by the turns at one end of the coil and the turns at the other, and, in fact, between individual

tioned that the use of reaction in this way is strictly forbidden by the Post Office, in view of the fact that if the coupling is made too tight between

High-Frequency Amplification Circuits

We now come to a class of circuit which is particularly suitable for the experimenter who desires to receive over long ranges or on a poor aerial. When a station is inaudible on one valve, or is received only very weakly, it is desirable to use the first valve as a high-frequency amplifier, and the second as a detector.

Fig. 5 shows a theoretical two-valve circuit in which the first valve V_1 acts as a high-frequency amplifier and the second valve V_2 as a detector. It will be seen that in the anode circuit of the valve V_1 we have the oscillatory circuit L_2, C_2 , which is tuned to exactly the same frequency as the incoming signals. The anode circuit of the first valve is F_1, A_1, L_2, C_2, F_1 . The oscillating potentials on the grid G_1 produce increases and decreases of anode current which pass through the inductance L_2 . A sudden variation of the current flowing through L_2 will set up an oscillation

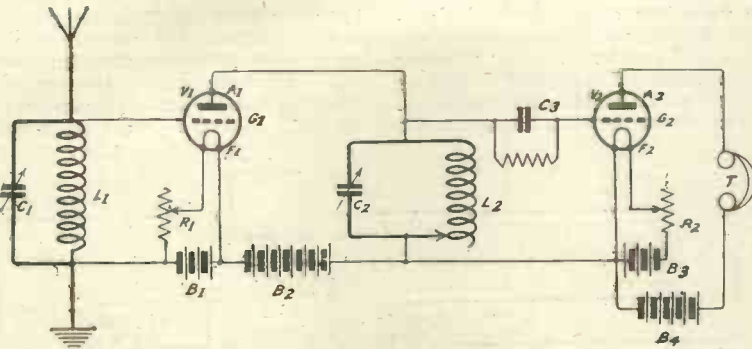

Fig. 5. Theoretical circuit in which first valve is a high-frequency magnifier.

turns. If the condenser C_3 is omitted it will usually be necessary to couple L_2 more tightly to L_1 .

L_2 and L_1 , the first valve will oscillate or generate continuous oscillations, which being passed into the aerial will cause the set to act as a miniature

Tuning the Reaction Coil

In Fig. 4 I have shown a variable condenser C_4 connected across the reaction coil L_2 . The condenser is in dotted lines, because if its use can be avoided, so much the better. In many cases, however, difficulty is experienced in obtaining sufficient reaction, and under the circumstances, matters may be improved by tuning the circuit L_2, C_4 to the wavelength of the incoming signals; a stronger reaction effect will then be obtained. The magnitude of the reaction, of course, may be varied, not only by varying the coupling between L_2 and L_1 , but by varying the tuning of L_2, C_4 . Maximum reaction effect is obtained when L_2, C_4 is tuned to the same frequency as the incoming signals. A slight detuning will cause a large variation of the reaction, and if the circuit is tuned completely off the incoming wavelength, no reaction effect at all will be obtained.

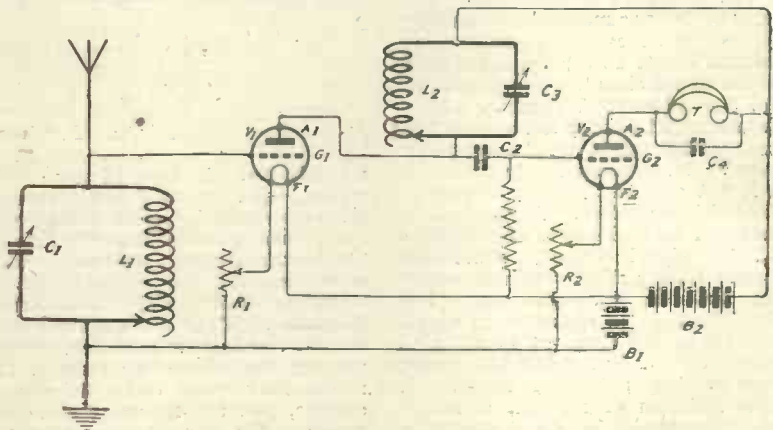

Fig. 6. The above circuit in practical form.

transmitter. When oscillating in this condition, the set will receive continuous wave stations, and the circuit is therefore particularly useful on

in the circuit L_2, C_2 , but this oscillation would only carry on for a fraction of a second. If, however, we keep on giving impulses of current through L_2 , we can keep the oscillations in L_2, C_4 swinging. This, however, necessitates accurate tuning of the circuit L_2, C_2 . If the tuning is different from the incoming one, the anode current variations will not set up oscillations in the circuit L_2, C_2 . Even a slight detuning of this circuit will weaken considerably the oscillations set up in it.

Having obtained in L_2, C_2 oscillations of similar frequency but greater intensity than those in the aerial circuit, we now proceed to rectify them by applying the potentials across the grid and filament of the second valve V_2 acting as a detector on the leaky grid condenser principle. The rectified signals are heard in the telephones.

The Fig. 5 circuit is reproduced in Fig. 6, a single high-tension battery and a single filament accumulator only being used. An additional modifica-

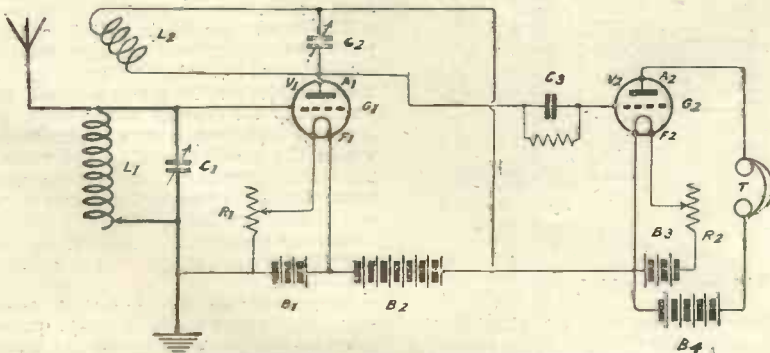

Fig. 7. The previous circuit modified to use reaction on the aerial-coil.

The Ban on Reaction

Before passing from the circuit of the Fig. 4 type it ought to be men-

tioned that the use of reaction in this way is strictly forbidden by the Post Office, in view of the fact that if the coupling is made too tight between longer wave-lengths. When oscillating, however, it is practically impossible to receive speech and music clearly.

tion has been introduced. The grid leak, instead of being connected across the condenser C_3 , is now connected directly between grid and the positive terminal of the filament accumulator. The reason for this change is that if we left the leak across C_2 , some of the positive potential of the high-tension battery B_2 would be communicated to the grid through the leak. If, instead of having a leak of high resistance, we used an ordinary piece of wire, the grid, of course, would have a positive potential equal to the voltage of a high-tension battery, and the circuit, of course, could not possibly work.

The action of the leak does not, in any way, differ when connected in the position shown in Fig. 6.

This method of coupling the two valves together is known as the tuned anode method, and is unquestionably the most fool-proof and efficient in nearly all cases.

Unintentional Reaction

When a circuit of this kind is connected up, it sometimes happens that the coupling between the circuit $L_2 C_3$ and the circuit $L_1 C_1$ is sufficiently great for a reaction effect to be obtained. This, of course, does not matter much and, in fact, is an advantage, provided the first valve does not tend to produce oscillations. The coupling effect, if the inductances L_2 and L_1 are kept well apart, is due to the capacity between the grid and anode of the valve V_1 , this capacity acting as a small coupling condenser as explained in my previous article on reaction. If this set tends too readily to oscillate, it is desirable to try connecting the earth lead, not to the negative terminal of the filament accumulator B_1 , but to the positive terminal, or to an intermediate point on the filament accumulator. This introduces damping into the grid circuit of the first valve, and lessens the tendency to oscillate.

grid leak of too high a value. Many home-made grid leaks, and quite a number of commercial grid leaks, have much too high a value, with the result that the set tends to oscillate.

Fig. 7 circuit is given in Fig. 8. In operating this apparatus, the main points to be noticed are as follows:—
The inductance coil L_2 should be at first kept widely separated from L_1 .

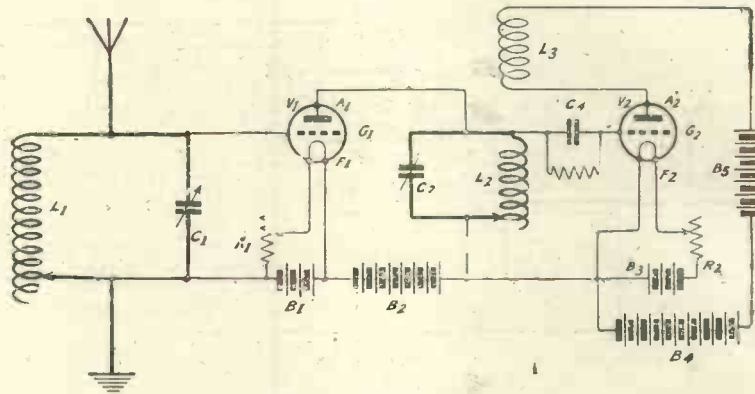

Fig. 9. Tuned anode coupling with reaction on the anode.

It is also desirable on a circuit of this kind to connect a condenser C_A across the telephone receivers. This condenser may have a capacity of $0.002 \mu F$, and will also tend to lessen self-oscillation of the set. On the other hand, where the tendency to oscillate is not present, it is quite likely that the addition of the condenser C_A will lessen the strength of signals.

Use of Direct Reaction

Although reaction may not be used on to an aerial circuit or closed receiving circuit when listening-in to British broadcasting, yet when listening-in to foreign stations, experimental transmissions and other signals, reaction on to the aerial circuit may be used with beneficial effects, and the arrangement shown in Fig. 7 is one which can be confidently recommended. The circuit is exactly the same as that of Fig. 5, but the

The two circuits $L_1 C_1$ and $L_2 C_2$ are then tuned until the loudest signals are obtained in the telephones. The coil L_2 is then gradually approached to L_1 , retuning being accomplished on the condenser C_1 and C_2 at every movement of the inductance L_2 . It will be found that if the inductance coil L_2 is brought too close to L_1 , the first valve V_1 will commence generating continuous oscillations. This, in some cases, may help the reception of distant spark signals, but will seriously interfere with the reception of speech. To test whether the valve is oscillating or not, it is a good plan to try the effect of touching the aerial terminal of the apparatus. A "plonking" noise indicates that the valve is oscillating. Loosen the coupling between L_2 and L_1 and try touching the aerial terminal again. If the valve is brought out of the oscillating stage, the noise heard in the telephone, due to touching the aerial terminal, will be very much smaller and will not have the same characteristic note. This test is not absolutely infallible in cases where the valve is producing only very feeble oscillations. The best test is the effect on spark stations. As the coupling is tightened, the musical note of the spark station is gradually lost and it becomes harsher. When the valve is oscillating, spark signals all seem to have the same note.

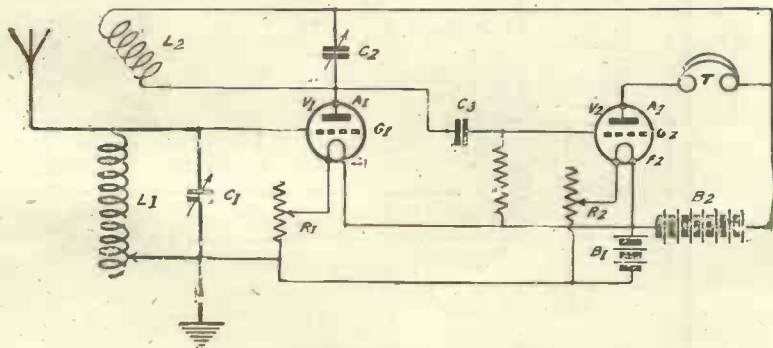

Fig. 8. Practical arrangement of Fig. 7.

Another expedient is to lessen the value of the grid leak. This leak introduces damping into the circuit $L_2 C_3$, and the undesirable tendency to oscillate may be due to having a

inductance L_2 has been coupled to L_1 . As before, both circuits $L_1 C_1$ and $L_2 C_2$ are tuned to the incoming wave-length.

The practical arrangement of the

Tuned Anode Coupling with Reaction

We now come to the ST34 type of circuit which, although it was described long before broadcasting came into vogue, has become the principal circuit at present used in this country, partly because of its effective operation and partly because it permits of reaction being used without contravening the Postmaster-General's regulations.

In Fig. 9 we have the theoretical arrangement in which reaction is introduced into the circuit $L_2 C_2$ by coupling the inductance coil L_3 in the anode circuit of the second valve to

quite readily. When this happens the oscillations may be transferred to the aerial circuit by the coupling between L_3 and L_2 in the anode of the first valve; the

In either case something should be done at once, as interference will be caused to neighbours. The coupling between L_3 and L_2 should be decreased, and some method adopted to prevent the first valve oscillating. One method is to connect the earth lead to the positive terminal of the filament accumulator instead of to the negative terminal. This will introduce grid damping into the grid circuit, due to the establishment of a grid current caused by the positive half-cycles impressed on the grid.

Alternatively, damping may be introduced into the anode circuit $L_2 C_2$ by lowering the value of the grid leak. Self-oscillation may also be largely prevented by using fairly large values of capacity in the condensers C_1 and C_2 . Generally speaking, it is desirable to have these values fairly low, but if too low the first valve will frequently oscillate, and if this happens a smaller value of inductance, and a larger value of capacity is desirable.

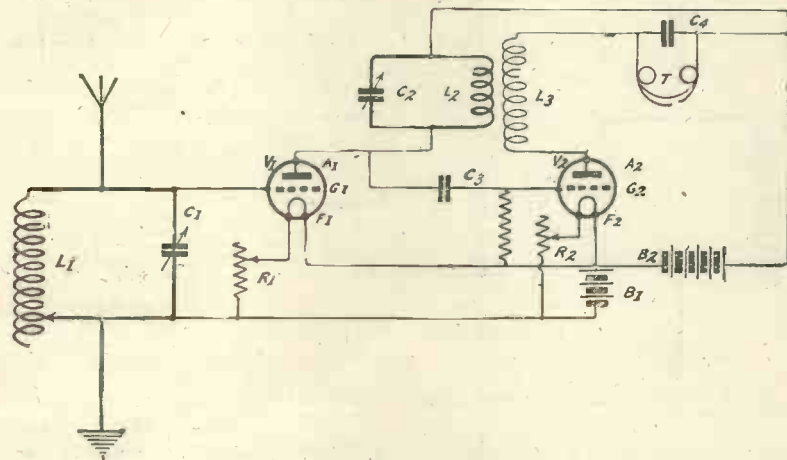

Fig. 10. A practical arrangement of Fig. 9.

the inductance coil L_2 . Of course, in this, as in all other reaction circuits, the experimenter should try reversing the leads to the reaction coil. If the leads are the wrong way round, the reverse effect of reaction will be produced, and tightening the coupling will only result in a loss of signal strength. Both the grid circuit $L_1 C_1$ and the anode circuit $L_2 C_2$ have to be tuned to the wave-length of the incoming signals, and at every new adjustment of the reaction coil L_3 , a slight readjustment of tuning of C_2 is required.

Fig. 10 shows the practical arrangement of the Fig. 9 arrangement, and here we have what is unquestionably one of the best possible straight-forward circuits for broadcast reception. This identical circuit was first published in my book, "Thermionic Tubes in Radio Telegraphy and Telephony." A speaker at a recent meeting, apparently questioning this statement, stated that the circuit had appeared repeatedly in the *Wireless World* for years. This, no doubt, is a tribute to the efficacy of the circuit, but only goes to show how easy it is when one has become fairly familiar with a circuit to forget its origin; the first time the circuit appeared in the *Wireless World* was May 6th, 1922—months after it had appeared in the above-mentioned book.

The value of the reaction coil L_3 is important, and different coils should be tried when experimenting on different stations. It is, of course, possible to tune this reaction coil by a variable condenser.

It must not be assumed that under all conditions this circuit will not radiate. In the first place the second valve may always be made to oscillate

radiation, however, will be very small. A great danger is that the first valve will oscillate, due to the coupling through the valve between the circuit $L_1 C_1$ and the circuit $L_2 C_2$. This is particularly the case if a loose-coupled tuner is used instead of a direct coupling, as shown in the figure. The oscillation test by touching the aerial terminal, is a fairly good one to see whether the first valve or the second valve is oscillating. If the first valve is oscillating, a variation of the condenser C_1 will produce a loud howl with the carrier-wave of, say, a broadcasting station. The slightest variation of the condenser C_1 will alter the

Another High-frequency Amplifier Using Reaction.

Fig. 11 shows the practical circuit for the reception of anything but British broadcasting. The circuit may not be used for the latter purpose as reaction is introduced on the aerial circuit. It will be seen that in this circuit, instead of the reaction being introduced directly into the aerial circuit from the second valve, or from the second valve into the tuned anode circuit, it is introduced from the anode circuit of the second valve to the grid circuit of the first. By doing this, not only do we get reaction into the aerial circuit, but there is also a reaction effect produced into the tuned anode circuit in

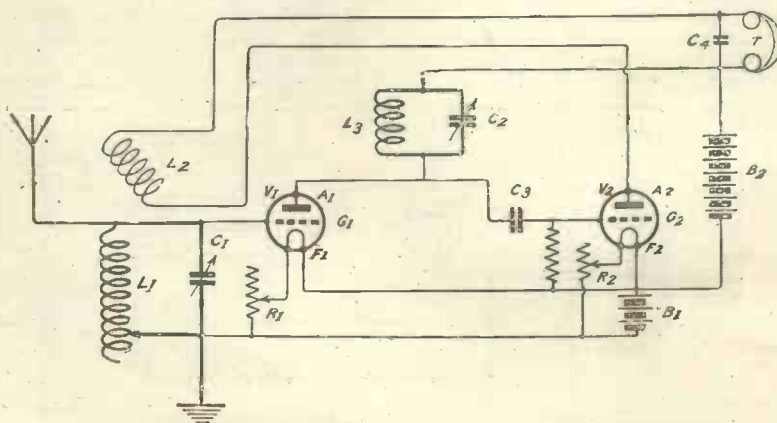

Fig. 11. A circuit in which reaction on the aerial circuit is obtained.

note of this howl. If, however, a howl is heard, due to the second valve oscillating, a slight variation of C_1 will only produce a very slight variation of the pitch of the howl.

an indirect manner. Whenever there is a chain of high-frequency amplifying valves, and reaction is introduced from the last valve to the grid circuit of the first, the benefit of the reactio

is introduced into all the intermediate circuits. The double reaction effect which I described in No. 1 of MODERN WIRELESS if used would help to ensure that the reaction is properly distributed over all the circuits in such a way that each is used to its best advantage.

The point to notice about this circuit is that since the currents flowing through the reaction coil L_2 have been amplified twice, the coupling between L_2 and L_3 need not be as great as if the currents had only been amplified once. It is therefore usual to employ a smaller reaction coil L_3 than would ordinarily be used. It is important in a circuit of this kind to see that the first valve does not oscillate, and various precautions, outlined above, may be adopted.

A Double Reaction Circuit

A circuit which must not be used for the reception of British broadcasting, but which may be used with good

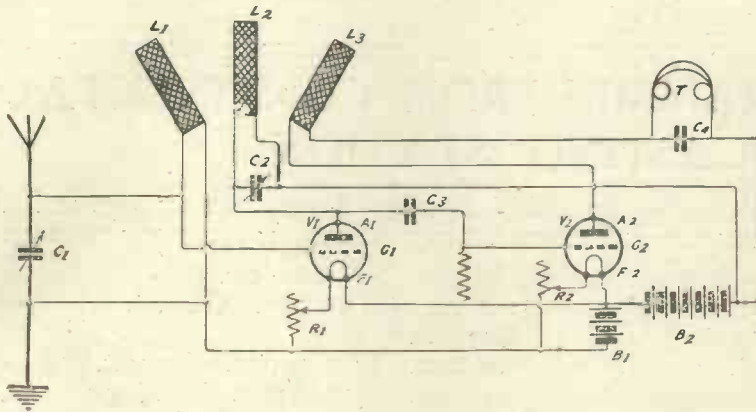

Fig. 12. An interesting circuit for the experienced experimenter.

effects on other signals, is illustrated in Fig. 12. It will be seen that there is a grid inductance L_1 , a tuned anode inductance L_2 , and a reaction coil L_3 . The coil L_2 acts as a reaction coil for the aerial circuit, and L_3 acts as the reaction coil for the tuned anode circuit $L_2 C_2$. If the different inductance coils are carefully chosen, very good results may be obtained with this circuit, and the selectivity is also very good. The circuit, however, will not work well unless in the hands of an experienced experimenter, and the beginner is advised not to use it.

Under some conditions an increase of signal strength of ten per cent. is obtained, and under other circumstances an increase of strength of fifty per cent. is obtained over the ordinary reaction arrangement. This depends entirely upon the design of the apparatus and the aerial employed, particularly the latter.

When using the arrangement of Fig. 10, a certain amount of reaction

leaks over, as it were, into the aerial circuit, due to the coupling of the valve V_1 . Whether this reaction is negligible or effective, may be judged by whether the tuning of the aerial circuit is critical or not. If the tuning of the aerial circuit is flat, and the condenser C_1 does not have to be adjusted very accurately, the use of a circuit of the Fig. 12 type will give improved results, as it provides a

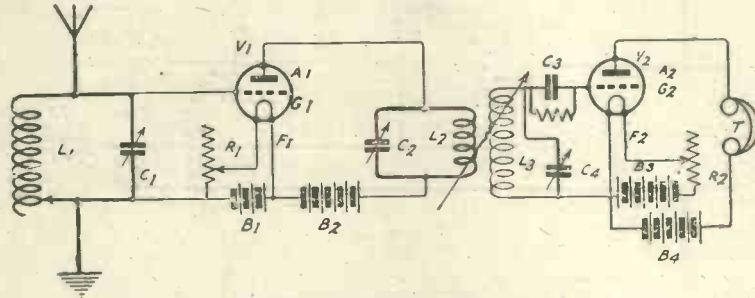

Fig. 13. Theoretical circuit using transformer coupling.

Transformer Coupling

Although tuned anode coupling has become very popular on account of its simplicity and effectiveness, yet transformer coupling is also very good if really good transformers are employed. There is, however, a great deal in the correct design of an intervalve high-frequency transformer.

In Fig. 13 is shown a theoretical circuit in which the first valve acts as

a high-frequency amplifier, and the second valve as a detector. It will be seen that the coupling is effected by two inductances L_2 and L_3 , each of which is shunted by a variable condenser to tune it to the incoming wave-length. The coupling between L_2 and L_3 may either be fixed or variable. When variable, the arrangement will be very selective, and on this account the practical form of the circuit is shown in Fig. 14.

If the transformer windings are fixed in relation to each other a certain degree of coupling will usually be found to be the best. If the coupling is fairly tight, there is need only to tune one of the transformer windings and this may either be the anode circuit, as shown in Fig. 15, or the grid circuit. Both arrangements seem to give equally good results.

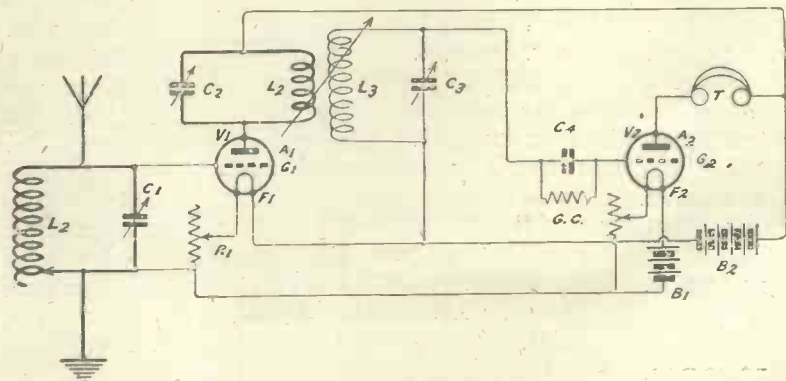

Fig. 14. Practical form of Fig. 13.

means of introducing more reaction into the aerial circuit, and the fullest reaction may be introduced into both the aerial circuit and the tuned anode circuit, the best results being obtainable under these two conditions.

Adding Reaction

Reaction may be added to the Fig. 15 circuit by connecting a reaction coil in the anode circuit of the second valve and coupling it, either to the

aerial inductance L_1 , or to the anode inductance L_2 . If the reaction is to be used on British broadcasting signals, the reaction must be introduced into the coil L_3 .

Conclusion

In nearly all cases, readers desire to have some opinion on the relative merits of all these different circuits, and it is always the most difficult

part of an article to give advice which will apply to all. In fact, it is practically impossible to give an opinion which will not be questioned by half one's readers. For general work on broadcasting, I favour my own circuit shown in Fig. 10. For other work, the circuits of Fig. 12 and Fig. 8 are probably best. It has always been my opinion, however, that the experimenter should buy component parts all mounted up with separate units, such as valve holders, coil holders, etc., and to wire these up in different ways. It is infinitely better to do this than to make up a complete set out of parts, and then pull it to pieces again when some new circuit comes out, or when one is tired of the results obtained. As a standby, of course, it is very useful to have a made-up set, but for experimental work the chief interest lies in trying out different circuits. The most curious thing about experimental work is that no two experimenters ever agree as to the relative merits of different circuits.

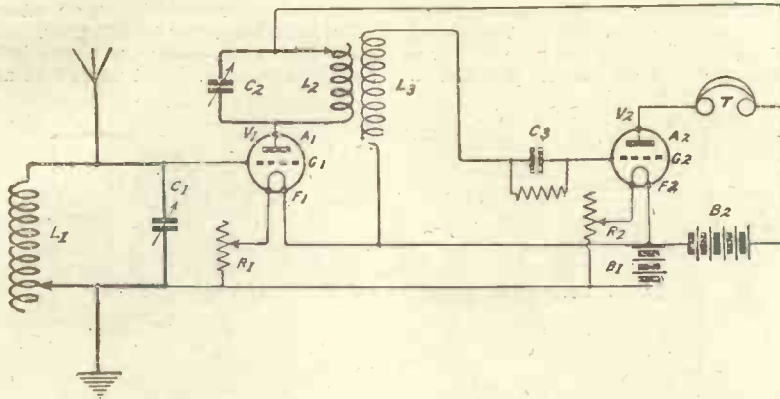

Fig. 15. A modification of Fig. 14 in which only one winding of the transformer is tuned.

REGULAR PROGRAMMES FROM CONTINENTAL BROADCASTING STATIONS

(Times in British Summer Time.)

For British Broadcast Programmes see page 424.

FRANCE.

PARIS, EIFFEL TOWER. (FL, 2,600 metres.)

Weekdays (daily).

- 7.40 a.m. Meteorological forecast.
- 12.15 p.m. Meteor. forecast and time giving
- 3.30 p.m. Financial bulletin.
- 6.10 p.m. Concert.
- 7.20 p.m. Meteor. forecast.
- 11.15 p.m. Meteor. forecast.

Sundays.

- 6.10 p.m. Concert.
- 7.20 p.m. Meteor. forecast.

Other concerts specially announced from time to time.

PARIS, RADIOLA. (1780 metres.)

Weekdays (daily).

- 12.30 p.m. Information (Cotton Exchange, Havre, Liverpool, Alexandria).
- 12.40 p.m. Concert.
- 5.0 p.m. Commercial information.
- 5.10 p.m. Financial information.
- 5.20 p.m. Concert.
- 8.45 p.m. News.
- 9.0 p.m. till 10.0 p.m. Concert.
- Thursday, 9.45 p.m. till 10.30 p.m. Dancing concert.

Sundays.

- 2.0 p.m. till 3.0 p.m. Concert.
- 8.45 p.m. News.
- 9.0 p.m. till 9.45 p.m. Concert.
- 9.45 p.m. till 10.30 p.m. Dancing concert.

PARIS. SCHOOL OF POST AND TELEGRAPHS.

Tuesday and Thursday.

8.30 p.m. Concert.
And very frequent radiophone transmissions of plays (comic operas).

LYONS. YN, 3,100 metres.

- 10.45 a.m. Concert (gramophone).
- 3.35 p.m. Financial news.

NICE. RADIO RIVIERA.

- 12.0 noon. News and concert.
- 6.7 p.m. News and concert.
- 9.10 p.m. News and concert.

HOLLAND.

NEDERLANDSCHE RADIOINDUSTRIE. THE HAGUE. PCGG, 1,085 metres.

- 3.0 p.m. to 5.40 p.m. Concert, Sunday.
- 8.40 p.m. to 9.40 p.m. Concert, Thursday.

GERMANY.

KONIGSWUSTERHAUSEN. LP, 3,200 metres.

- 4.0 p.m. to 5.30 p.m., and at intervals during the day.



Our Fine New Words

EVERY new sport, pastime or hobby that comes along adds its contribution of new words to the enormous and ever-growing vocabulary of our language. What will happen to the Murrays and the Websters of a century hence one can scarcely think; the dictionary of their day will probably require the best part of the shelving of a good-sized library to its own cheek. Wireless is no exception to the rule, and besides having added a considerable number of fresh words, it has made many that would otherwise have been confined within the covers of learned books on science familiar, almost household, terms at the present day. A year or two ago, if one had mentioned in a drawing-room such words as "hysteresis" or "heterodyne," one's hostess might have looked pained at the time and have mentioned quietly afterwards when suitable opportunity arose, that she might be old-fashioned, but still she didn't care to hear medical terms of that kind used when young people of both sexes were present. Now she will fall upon your neck, if in an absent moment you let slip one or two technical jawbreakers. Often she is prepared to take you up, and to argue ably about a point that you have raised. If not, she gushes, "Oh, Mr. Snookins, I know you're *such* an authority on this fascinating wire-

less. Do tell us how it works." In either case you are for it.

A Short and Easy Way with Bores

The possession of a stock of sesquipedalian wireless terms of the most abstruse kind may, however, afford a present help when one is hard pressed by certain types of bore. One day at my club the most devastating of these came up to me, slapped me on the back, and said, "Ah, Listener, I've just got half an hour to spare. D'you mind explaining to me exactly how wireless is done?" Attack was obviously the only sound form of defence in this case. In two minutes I had so frightened him with "pi's," square roots, and the ever-blessed words inductance and capacity that he suddenly remembered an appointment and fled headlong. There is another kind of fellow, too, whom you can rout decisively and with great speed. I refer to the man with one idea. He may be a musical fanatic, a golfer, an angler, a racing maniac, or a collector of postage stamps. He sits down beside you and proceeds forthwith to recount, let us say, how he did the umpteenth hole in three, thanks to his new skew-faced mashie. You retaliate by giving him a description of the way in which you make certain of receiving America broadcasting by using the latest double reaction circuit. You will go into details.

He wilts visibly. Pale but determined he tells his thrilling adventures on the green. You cut him short with a disquisition on the merits of anti-capacity valves. In a few brief moments victory is yours. The evil spirit flees, exorcised by the exuberance and abstruseness of your vocabulary, and all the world looks smiling once more.

The Crop of Aerials

There are few more amazing sights than that to be witnessed by anyone who cares to look out of the windows of a railway carriage whilst his train is approaching London. Aerials have sprouted everywhere, stretching from trees, masts, clothes' props, and even fence-rails to various parts of the anatomy of the houses to which they belong. Wireless appears somehow to be infectious. If one house has an aerial, its neighbours seem to be similarly provided. You will see a little group of the wires and spreaders that mark the dwellings of good men and true who are wireless enthusiasts to the last amp of their accumulators. Then comes a gap inhabited by the unenlightened. This again is succeeded by other clusters of aerials. Some of them are beautifully put up, others would pass in a crowd, of others again perhaps the less said the better. One that I pass every day is a perfect example of how not to do it. It was erected, I am told, by a firm

who sent a platoon of workers down especially for the purpose. The house is a long one with admirable chimney stacks—I envy their owner those chimneys—at either end. Naturally the masts are fixed to the stacks. On one gable end is a wooden arm provided with an excellent insulator which is meant to lead-in at arms' length, so to speak, on its way from aerial to window-frame. Unfortunately, the genius who put up this affair allowed a too generous amount of slack between the aerial and the insulated strut. The result is that several feet of the bare lead-in rests gently upon the tiles of the roof. Can you not imagine the worthy owner of the set wondering why he can't get such results as should be his by right, cursing this and that, writing scathing letters to the makers of valves, batteries, 'phones and the hundred and one bits and pieces that go to make up a receiving set, and generally having as rotten a time as a hardly dealt with wireless man can have? The source of his troubles, if he but knew it, is, of course, that his aerial is at all events partially earthed before it can get near his set. He wants his full share of transmitting stations and believes that he is getting it. In reality he is receiving but a fraction of the kicks that each signal makes.

Neglected Districts

It is curious to strike a place that has not so far received a visit from the wireless microbe and therefore knows nothing of the epidemic of aerals. I was in York a few months ago, and the astonishing thing was that there was hardly a visible sign of the wireless man's craft to be found. Things have probably altered since then, though I rather doubt it, for York is not well-off as far as broadcasting is concerned. Newcastle lies a long way North; to the West—very much to the West—there is Manchester, and away in the Midlands there is Birmingham. Conditions are even worse as one moves towards the coast, for there the nearest broadcasting station is so remote that the crystal unaided by valves is of very little use. The West Riding of Yorkshire is, I believe, the most densely populated part of England, with the exception of London.

If it were provided with a broadcasting station, or even a relay station, at Leeds an enormous amount of trade should be done in wireless apparatus, for your Tyke always want to be up-to-date, and 'e'll find t'brass fer woon o' these 'ere wireless sets as soon as there's owt to listen to, tha knaws. Such a station would also serve York and the East Riding.

An Aid to Beauty

The effects of any great new movement are always far-reaching; and sooner or later the popular Press discovers them and points them out to its readers in columns packed with lurid adjectives and introduced by three-line headings. We have had the cycling slouch, the golfing bad temper, the angling tendency to untruthfulness, the motoring face seamed with anxious wrinkles duly retailed for our delectation. But so far little has been said about wireless, which is certainly one of the most important of modern short cuts to masculine beauty. Have you not noticed a marked improvement in the personal appearance of those of your friends who have adopted it? You haven't! Tut, tut! Where are your powers of observation? Regard, for example, the ears of Jones. A few short moons ago rude boys remarked upon their obtrusiveness, for they stood out on either side of his cranium like the spinnaker and mainsail of a racing yacht running home before the wind. What of them now? Thanks to long evenings spent with the 'phones tightly clamped about his head, Jones has all unwittingly, but to his profound satisfaction, curbed the exuberance of those ears. No longer do they project east and west at right angles from his skull. Instead they lie as closely and as tidily as the most fastidious could desire. Robinson had unruly hair, of the type that defied the stickiest brilliantine, or even (during his army days) gear-box grease. Look at him to-day. His locks lie as closely about his head as those of the most begreased of dandies. Pressure from the head-bands has worked wonders.

The Fly in the Ointment

But there are those who claim to be able to detect at sight the wireless face. There are lines denoting ill-temper, they say,

around the mouth, their presence being due to interminable searches after unfindable faults. Then the mouth itself is apt to be held slightly ajar, which lends a vacant look to the least nightmarish of faces. The first insinuation I resent most strongly, for I feel sure that no one could be endowed with a more sunny temper than the average wireless man. It must be so, else he would kill out of hand those who laugh at him when he is investigating the cause of some trifling mishap which has just put the set out of action for the time being, or those who ask the inane question to which he must submit a score of times during the day. The second has in it just that substratum of truth that makes one think. Don't you, when you are listening for very faint distant transmissions, unconsciously allow the lower jaw to sag? Notice next time you are so engaged. It is quite reasonable to do so, for one hears better with the mouth open.

A Shocking Affair

A kitten has just adopted me. It walked in a day or two ago, climbed on to my shoulder without any introduction and intimidated by every possible sign short of actual speech that it intended to stay. As I write it is lying on my table, sunk in the most blissful slumber. Save that it will keep edging on to my paper—all cats love paper as a bed—it is a most excellent companion. It gave me a nasty turn this afternoon, though, when it arrived on my littered wireless bench, and proceeded to wander amongst a number of almost priceless low-temperature valves. However, it negotiated all these obstacles, and a good many more, without so much as moving a thing. I do not think all the same, that it will repeat its visits to this particular spot. At the end of the table were flex leads coming from a collection of dry batteries used for grid biasing purposes. Puss pawed them delicately, then suddenly seized first one and then the other in his mouth. A jump, a spit like the explosion of a soda water syphon, a glance of mingled sorrow and anger, and he was racing full tilt down the garden. A score of volts on a wet tongue must have produced something more than a nasty taste!

THE LISTENER-IN.

A SIMPLE CRYSTAL RECEIVER

By E. H. CHAPMAN, M.A., D.Sc., F.R.Met.Soc., (Staff Editor).

The design of this instrument will please many new readers who have decided to build a crystal set but have had some difficulty in choosing an efficient yet simple method of construction.

THE crystal receiver described in the present article was designed to fulfil the following requirements:

- (i.) robust construction;
- (ii.) simple tuning;
- (iii.) cheapness.

The first of these requirements was considered to be the most essential, and robust construction was taken to include the necessity for providing a crystal detector which would give a sensitive setting lasting for weeks without attention or alteration.

Experience had shown that the more usual type of crystal detector in which contact is obtained with a wire or, as it is appropriately called, a "cat-whisker," was frequently requiring re-adjustment. Some of the "cat-whisker" crystals, Hertzite for example, are very sensitive, and a heavy-footed visitor walking across the floor of a room will put any "cat-whisker" off its mark and necessitate a trying search for a sensitive spot. Accordingly, in order to get a firm and lasting contact, a double crystal combination was decided upon for the set now described.

It was also a matter of experience that an inductance coil with slider for tuning purposes can be very stubborn at times and that nothing short of a rolling wheel contact can be considered consistently reliable. Of other methods of tuning, those requiring a variable condenser were, like a rolling wheel contact on an inductance coil, passed over on the grounds of expense.

After a little consideration it appeared to the writer that the best proposition for a cheap and simple method of tuning was a

variometer made of inexpensive material.

The Variometer

As will be seen from the photograph in Figure 2, the variometer finally decided upon consisted of a flat cardboard disc rotating inside a cardboard cylinder of slightly larger internal diameter. The actual measurements of the cylinder were:

- Outside diameter $3\frac{1}{4}$ inches.
- Inside diameter $3\frac{1}{8}$ inches.
- Length $2\frac{1}{2}$ inches.



Fig. 1.—The complete instrument.

The cardboard disc had a diameter of 3 inches, the central portion free from wire being 1 inch across.

On the cylinder 30 turns of No. 22 d.c.c. wire were wound, 15 turns on each side of a space $\frac{3}{8}$ inch across left for the spindle of the rotating disc (see Figure 2).

The cardboard disc had 7 radial slits cut in it at equal intervals, and altogether there were 42 turns of No. 24 d.c.c. wire on the card, 21 on each side.

The mounting of the disc on a brass rod $2\frac{1}{4}$ inches long was

accomplished in a simple manner. Over one end of the rod a piece of thick red rubber tubing 1 inch long was slipped. This rubber tubing fitted the brass rod very tightly. As the wire was wound on the disc, all the turns on one side were taken over the rubber-covered brass rod which was carefully held in position along a radius of the disc. It was found quite easy to pull the wire taut and get a good grip on the rubber. When the winding of the card was complete, it was found that the brass rod could not be rotated without rotating the "spider-web" coil with it.

The two ends of the wire on the flat coil were pushed through the hole made in the cylinder, the brass rod also being pushed through the same hole. So that the leads from the flat coil should have plenty of room to move, the hole in the cardboard cylinder was made much bigger than would have been required for the brass rod alone. One free end of wire from the disc was soldered to one of the free ends of wire on the cylinder.

The Crystal Detector

The crystal detector was made on the lines of that described on page 27, *Wireless Weekly*, No. 1, April 11th, 1923. The base was a strip of ebonite 4 inches long and $\frac{1}{4}$ inch wide. A terminal was mounted on the ebonite and a strip of brass sheeting $4\frac{1}{2}$ inches long, $\frac{1}{2}$ inch wide, with two holes punched through. It was then fitted on the shaft of the terminal as shown in Fig. 3. On the free end of this brass strip, a crystal cup was mounted in an inverted position. Two other crystal cups were mounted on the

ebonite strip, one at each end, in positions such that they would come directly under the inverted crystal cup on the brass strip. Under each of the lower crystal cups a small piece of copper foil was placed so that connecting wires could easily be soldered to the foil and contact readily established with the crystals.

In the upper inverted cup a small piece of zincite was screwed. In one of the lower cups a piece of bornite was placed and in the other cup a piece of crystal which is sold under the name molybdenite.

By turning the brass strip round the terminal shaft the zincite could be made to work with either the bornite or the molybdenite.

The Containing Box

In order to make the set steady and firm in use, the base of the containing box was made of wood an inch thick. This baseboard was 6½ inches long and 5½ inches wide. The two sides and back were nailed securely to the baseboard. It is only necessary to state that the overall height of the box was 5½ inches, and that the wood used for all except the base was ¼ inch thick, in order to give working measurements for making a similar box. A novel feature was that the front of the box was made to slide in grooves provided in the baseboard and in the top of the box.

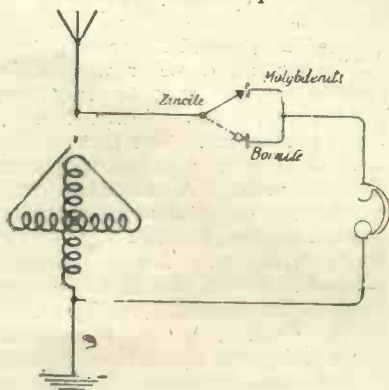

Fig. 4.—The circuit used



Fig. 2.—The box open, showing simple variometer.

The reason for the sliding front is apparent from Fig. 2, which shows how the crystal detector was mounted inside the box, so that when the crystal detector has once been set, the box can be shut up and the crystals protected from dust.

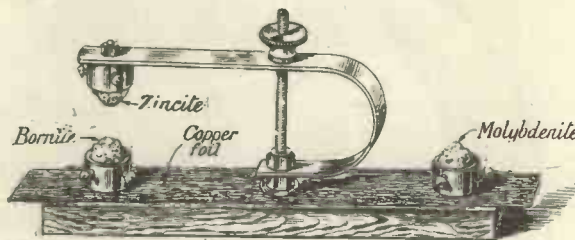

Fig. 3.—The double crystal detector.

The variometer was mounted on the lid of the box, a knob being fitted along with a pointer on the brass rod outside the box. Two small screws were sufficient to hold the cardboard cylinder of the variometer in place. On the top of the box one terminal was provided for the aerial lead and a second for the earth. The telephone connections consisted in this set of two valve sockets, the telephones used having had their leads soldered to valve pins mounted on a small strip of ebonite. It is perhaps worth mentioning that the terminals and valve sockets on the lid were each fitted with two fibre washers, one on the outside of the lid and the other on the inside, the holes through the lid being larger than the shafts of the terminals or valve sockets.

the magnifier, to obtain much greater strength. Such magnifiers, however, do not increase the range of the set, but only the strength of signals.

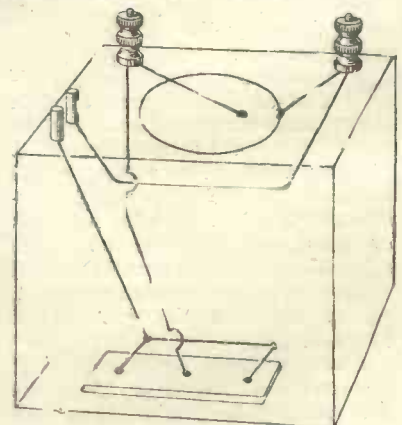

Fig. 5.—The wiring diagram.

Circuit and Wiring

The circuit used was similar to that known as *Wireless Weekly* Circuit No. 1, the modifications being the substitution of the variometer for the sliding inductance and the two-way crystal detector. Fig. 4 shows the circuit diagram in the usual manner and Fig. 5 is a pictorial representation of the way in which the wiring was done in the box.

Results

2LO at a distance of 14 miles is very clear on the telephones, and the addition of two low-frequency amplifying valves gives good loud-speaker strength.

Perhaps the best thing that can be said about the set is that no fewer than three near neighbours who have seen the set working have promptly borrowed it and made one like it.

For Strong Signals

Those readers who wish to obtain a greater strength of signal can, of course, add valve magnifiers quite simply. It is only necessary to attach the "input" terminals of the note magnifier to the telephone terminals of the crystal set, and transfer the telephones themselves to the corresponding terminals of

THE TRANSMISSION OF SPEECH BY LIGHT

By Professor A. O. RANKINE, O.B.E., D.Sc., Imperial College of Science and Technology, South Kensington.

On April 25th Prof. Rankine broadcast a lecture from 2LO on the above subject. This has excited considerable interest, and in response to the wishes of a large number of our readers, Prof. Rankine gives below a full account of his invention and the results he has obtained.

WIRELESS telephony is understood to mean the transmission of sound by the agency of ether-waves, the reproduction of the sound depending upon the modulation of the form of the waves. This development of wireless telephony is of fairly recent growth.

But a form of wireless telephony was invented and used many years ago which had much in common with the wireless telephony of to-day, in that it employed ether-waves, these, however, being within the visible spectrum (light-waves). In 1880 Graham Bell invented the "photophone," an arrangement by which a beam of light was sent from a transmitting to a receiving station, variations being impressed upon the intensity of the beam corresponding to the sound-waves of the voice, and the sound being reproduced at the receiving end. In 1900 Ernst Rühmer carried out photophone experiments for the German Government; he used an electric arc as his source of light and caused the current through the arc, and hence the candle-power, to be varied in accordance with the speech sounds at the transmitting end.

Both these methods were attended with some success, and it can therefore be said that a form of wireless telephony existed a matter of forty years ago.

In 1916, whilst working for the British Admiralty, under the direction of Sir William Bragg, I had the duty of investigating possible methods of short-distance directional wireless communication, and, the use of light having been suggested, it occurred to me that the method of the photophone might be improved, so as to permit of

greater simplicity and reliability. After thinking the matter over very carefully one evening, I decided upon the design of the apparatus and was able the next day to have it constructed in crude form and tried, with the gratifying result that it was at once successful. A large amount of experimental work has since then been carried out with this device, but it is of interest to note that no essential alterations in the arrangements have needed to be made since the original trial.

Before dealing with my invention, however, I will give a brief

account of the intensity of the incident light.

My invention is concerned largely with improvements in the means of imposing the variations, due to the sound-waves, upon the transmitted beam; that is to say, it is connected chiefly with the transmitting apparatus. The receiving apparatus employed is similar to that which was employed by previous investigators. It will be useful to describe next the principle upon which the receiver depends.

Action of Light on Selenium

There are certain substances, of which selenium is the best-known example, which have the remarkable property that their electrical resistivity is affected by the incidence of light upon them. If a piece of suitably prepared selenium be mounted between metal contacts and included in a circuit with a telephone receiver and a battery, the total resistance of the circuit

will vary when light falls upon the selenium. The arrangement of the selenium in its metal contacts is known as a "selenium cell." If the light which falls upon the selenium cell varies rapidly in intensity, the current through the telephones will vary with the same rapidity. For example, let us suppose we have a beam of light projected upon a selenium cell (see Figure 1) and interposed in the path of the light a rotating disc in which 10 slots are cut, the disc rotating, say, 20 times per second. The beam will thus be interrupted 200 times per second, and the current through the telephones will be varied with the same frequency: thus a note will be heard in the telephones corresponding in pitch to the frequency of variations of the light-beam.

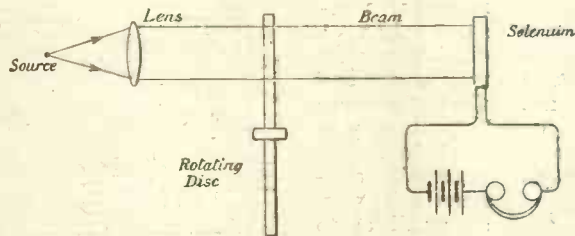

Fig. 1.—Interrupted light-beam falling upon selenium cell and producing note in telephone.

account of the earlier work of Graham Bell and Rühmer.

Principle of the Photophone

The photophone, both in the earlier and the latest forms, consists essentially of the following components: firstly, a device at the transmitting end which shall project a beam of light to the receiving station (which may be several miles away), together with some arrangement whereby the intensity of the light-beam may be caused to fluctuate in accordance with the sound-waves which it is desired to transmit; secondly, at the receiving end, a device which shall enable the light-energy to control electrical energy, so as to actuate a telephone receiver, the strength of the current varying in

Selenium is not the only substance from which a "photoelectric cell" (as it is called) may be made. There are other substances which are known to have

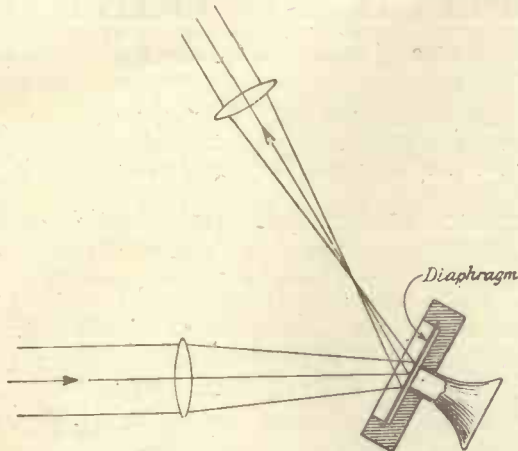

Fig. 2.—Principle of Graham Bell's original photophone. Diaphragm acts as mirror and varying curvature causes variations in intensity of beam.

photoelectric properties. For example, T. W. Case has recently constructed what he calls a "thalofide cell," the active substance being sulphide of thallium, and W. S. Gripenberg has produced the "antimonite cell," the active substance being sulphide of antimony. The relative merits of these various cells, however, need not concern us here.

The system indicated in Figure 1 represents the underlying principle of the photophone receiver.

Graham Bell's Photophone

Using this scheme, Graham Bell set to work to devise a method of imposing fluctuations upon the light-beam, to correspond to the sound-waves to be transmitted. The method which he eventually adopted was to employ a thin

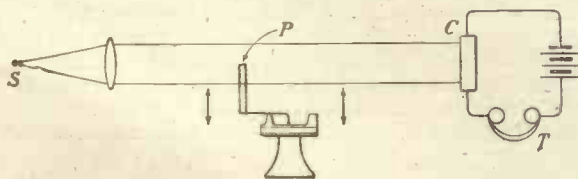

Fig. 4.—To illustrate roughly principle of the modern photophone. Opaque shutter P cuts off varying amounts of light when diaphragm is in vibration.

concave mirror (see Figure 2), from which the light was reflected and concentrated upon the selenium cell. The mirror acted also as an acoustic diaphragm; when sound-

waves fell upon the mirror and caused it to vibrate, its radius of curvature was varied in accordance with the sound-waves and the position of the focus was altered. Thus the selenium cell, being in a fixed position, was at varying distances from the shifting focus. Or to put the matter in another way, the effect was the same as if the curvature and focus of the mirror had remained constant and the selenium cell had vibrated in position about the focus, in accordance with the sound-waves. The net result was that the total amount of light falling upon the selenium cell was fluctuating and thus the variations due to the sound-waves gave rise to variations in the electric current in the receiving circuit, and could

again be transformed into sound-waves in the telephone receiver.

There were several objections to Bell's system, the principal being that the vibrations of the mirror, considered as a diaphragm, were very small, and the variations in the intensity of the light falling upon the selenium cell were so small as to render the reproduction extremely faint.

Rühmer's Photophone

Rühmer's method was different in principle from Graham Bell's. He employed as his source of light an electric arc, and by means of a transformer (as roughly indicated in Figure 3) and a microphone transmitter, he was able to superimpose electrical variations, corresponding to the speech sounds, upon the steady current which maintained the electric arc: thus the brightness of the arc was varied in accordance with the sound. This method was used with some

success by the German Government, and it was claimed that speech was transmitted over a distance of several miles. There were several serious disadvantages met with in the use of this apparatus, however, the chief one being the difficulty of maintaining the arc in a steady condition. Oscillations are liable to occur in an electric arc, as is well-known, and these gave rise to hissing and other noises in the receiving telephones. Furthermore, the variations of current which could be superimposed were small compared with the steady current maintaining the arc. Another practical limitation of this apparatus was that it was confined to electrical sources of light; in particular, it was not available for use with reflected sunlight, which is very powerful, and hence convenient for photophone signaling by day. It may be mentioned that during the war H. Thirring used a method similar to Rühmer's, but with a filament lamp instead of an arc.

The Vibrating Image "Shutter"

The method which I have evolved in my recent development of the

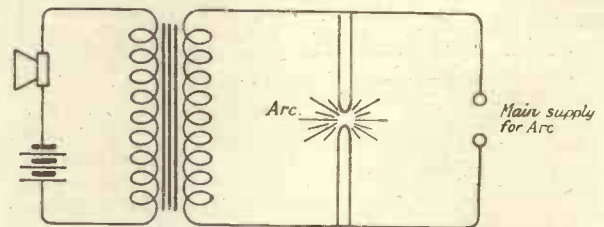

Fig. 3.—Principle of Rühmer's photophone. Speech-currents are superimposed upon steady current maintaining arc or electric lamp.

photophone depends upon what may be called a "vibrating shutter" which, by its vibrations, in effect opens and closes an aperture through which the light-beam passes.

It constitutes an improvement on a device suggested by Sir William Bragg, who at the time was unaware of the fact that Graham Bell had already evolved the principle—had, indeed, patented it—but had made no use of it because of difficulties in the way of its practical application. A consideration of this unsuccessful proposal will, however, serve to elucidate the steps whereby it has been improved.

In Figure 4 is shown a beam of light from a source S concentrated upon a selenium cell C. In the

path of the beam is interposed an opaque screen P which is attached to the stylus-arm of a diaphragm, such as that of an ordinary gramophone sound-box. It will be evident that if speech sounds enter the trumpet, the diaphragm will vibrate in the direction indicated by the small arrows and the opaque screen P will also vibrate as indicated by the

If a screen, in which a wide slot is cut, be placed behind the lens L_1 in Figure 6, the light, after reflection from the mirror, may be made to throw an image of this slot upon another screen placed before the lens L_2 , a slot being cut in this latter screen similar to that in the first screen. If the image of the original slot coincides with the second slot, the light will all get through, but if the mirror vibrates so that the reflected beam oscillates through a small angle the image of the first slot will vibrate about the position of the second slot and the amount of light which gets through will fluctuate in accordance with the vibrations.

divided into a number of parallel strips, a very small lateral movement of the image upon the second grating will bring the light strips of the image coincident with the opaque strips of the second grating, in which position the light will be totally extinguished (see Fig. 7); in other words, a very small motion of the diaphragm of the sound-box will produce a transition from what we may call "full light" to "total extinction." At intermediate positions the strength of the beam will be intermediate between its maximum strength and its minimum strength (the latter we may consider for the purpose of the argument to be zero).

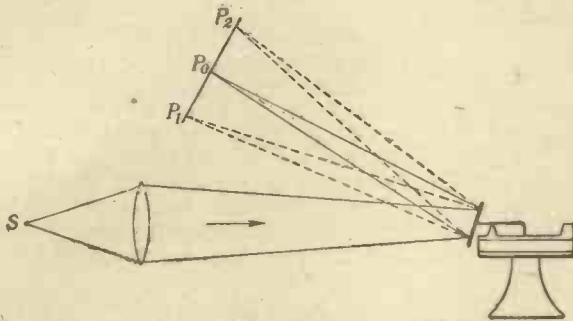

Fig. 5.—Light reflected from mirror. Vibrations of focus are magnified versions of vibrations of diaphragm.

arrows in such a way that it is alternately pushed further into the path of the beam and withdrawn from the beam: fluctuations in the intensity of the beam will thus be produced, corresponding to the vibrations of the diaphragm and these will cause corresponding variations in the electric current through the selenium circuit, with the reproduction of the sound in the telephone T.

The practical objection to the arrangement indicated in Figure 4 is, of course, that the motion imparted to the diaphragm, in practice, is much too small to produce appreciable fluctuations in the light, but it serves to illustrate in a simple way the underlying principle of my method.

Now consider Figure 5: here we have a gramophone sound-box, but instead of an opaque screen mounted on the stylus-arm, we have a small concave mirror M. If light is projected from the source S upon this concave mirror it will be reflected to a point P_0 . It will be evident that if sounds fall upon the diaphragm and cause it to vibrate, the mirror will vibrate, and in doing so it will be rotated through a small angle, with the result that the light rays will vibrate between two points, say P_1 and P_2 , which are, in fact, separated by a much greater distance than the actual vibration range of the diaphragm itself.

The system illustrated in Fig. 6 represents the essential principle of the modern photophone which I have now perfected.

In order to allow a large amount of light to pass through the system, it would be necessary (if we used the simple arrangement indicated in Fig. 6) to have the slot fairly wide, and this would mean that the image thrown upon the second slot at the position L_2 would have to vibrate with an amplitude of the same order of magnitude as the width of the slot. It is desirable, however (for reasons which are probably obvious), to make the apparatus capable of operating efficiently with only small amplitudes of vibration of the diaphragm.

The Gratings

Suppose, however, we adopt a plurality of slots, the width of each slot being the same as the distance between adjacent slots, it will be seen that half the area of the lens L_1 is covered by the opaque strips, and half is open for light to pass through. The image of this grating is focussed upon a second grating placed before the lens L_2 . Now, since the total open space is

The Completed Photophone

The arrangement shown in Fig. 7 is that which is adopted in the latest form of my photophone, and which has been found to be entirely satisfactory. In practice, matters are so arranged that when no sound is falling upon the diaphragm the position of the image upon the second grating is about midway between the positions for maximum and minimum light. Fig. 8 gives a photograph of the apparatus arranged for use with reflected sunlight, the two gratings being shown placed side by side. These gratings are carefully machined from thin brass plate. Fig. 9 is a photograph of the sound-box and

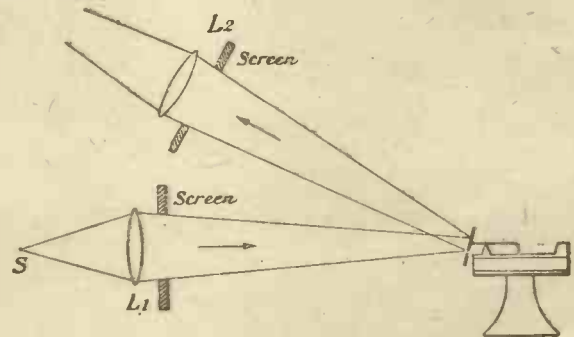

Fig. 6.—Rudimentary grating used with photophone: image of first slot is focussed upon second slot.

trumpet; the small concave mirror will be seen mounted normally at the end of the stylus-bar of the gramophone sound-box remote from the diaphragm. It will be noticed that the sound-box system is capable of rotation about a vertical axis by means of a worm-screw; this is to permit of the proper adjustment of the position

of the image upon the second grating in the normal undisturbed condition.

Practical Trials

The apparatus in the form illustrated and described above has been successfully used for the

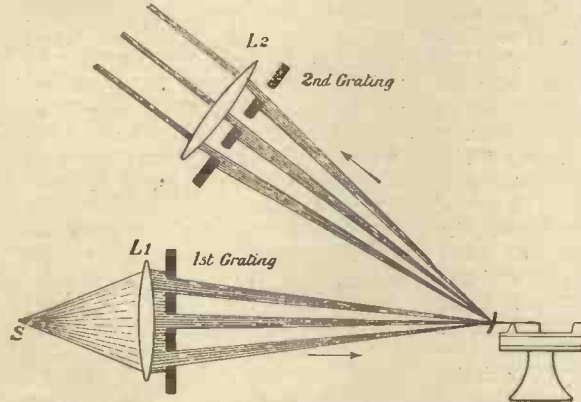

Fig. 7.—Principle of the latest form of photophone, showing first and second gratings.

transmission of speech over a distance of several miles. Any system for the transmission of speech by light is subject to the limitation that no opaque obstacles shall intervene between the transmitting and receiving apparatus; the possible range is thus, in any case, limited by the curvature of the earth. The photophone method, however, is not intended to compete with ordinary wireless telephony for long distances, and is essentially an apparatus for use at short ranges, and particularly for certain special uses which will be described presently. It may be mentioned, however, that its directiveness—*i.e.*, its capability of confining the light projected to a very small angle, gives it the advantage of secrecy not yet properly achieved in ordinary wireless.

The reproduction of the speech is remarkably faithful, and by means of valve-amplifiers the loudness can be enhanced in the usual way.

Recording Speech by Light

Probably the most important use of the photophone method is in connection with the recording of speech and its subsequent reproduction. Various attempts have been made by different experimenters to produce "talking pictures," that is, a cinematographic representation accompanied by the corresponding speech and

music. Most of the earlier attempts involved the synchronisation of some form of gramophone with the cinematograph film. The film, however, suffers various breakages and repairs, with consequent shortening, and in practice it has been found very difficult to maintain any sort of reasonable correspondence between the pictures and the sound.

Wavy Sound-trace

Attempts of quite a different kind have been made to record the sound actually upon the film itself, so that synchronisation should be automatic. In such experiments it has been usual to record the sounds upon the film by *transverse*

vibrations, such as, for example, the trace made by a vibrating spot of light on a moving photographic film. The record thus obtained does not lend itself readily to re-

production, although Mr. Bergland has recently announced the successful production of such a sound record upon a separate film, the sound-film and the picture-film being run simultaneously. More recently, Mr. Grindell Matthews has placed both the records upon the

Recording by Intensity

one film: he also uses the "wavy" trace for the sound. I have not witnessed demonstrations of either of these inventions, but Prof. Arrhenius, who was present at the first demonstration of the Swedish talking pictures, tells me that Mr. Bergland also employs the "wavy" sound-trace.

The recording of sound photographically by changes of the intensity of a beam of light renders the reproduction much easier. This process is not new, having been used in 1900 by Rühmer (an account of whose experiments is described in his book on "Wireless Telephony" translated into English by J. Erskine-Murray in 1908). The method was developed by Rühmer as a means of testing conditions under which the greatest variations of light-intensity could be produced by the action of microphonic currents superimposed upon the steady current maintaining the arc in his experiments (as described in the earlier part of this article). Rühmer finally succeeded in recording sounds by this means and also in reproducing them, but he

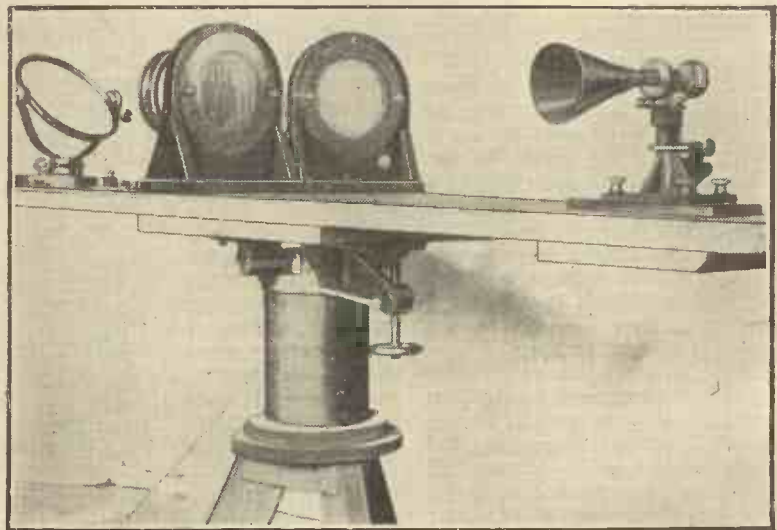

Fig. 8.—Photograph of photophone arranged for use with reflected sunlight. The first and second gratings are shown side by side.

points out that the manipulation is laborious, mainly owing to the difficulty of keeping the arc in a sensitive condition.

The Recording Camera

The photophone transmitter which I have developed surmounts

these difficulties very successfully and enables photographic records of sounds to be obtained with great ease and precision.

The arrangement by which the sound-record film is made are indicated in Figure 10. The light from a 500 c.p. Pointolite lamp is passed through the transmitter, and the resulting fluctuating beam is concentrated upon a slit S, an image of which is then focussed upon a cinematograph film in a suitable camera actuated by clock-work. The film may be run through the camera at a speed between 40 and 200 cm. per second. In some of my experiments the speed of the film was about 170 cm. per second and the slit was very narrow, about 0.1 mm. These arrangements were made in order to secure as much detail as possible on the film, but the film was rather underexposed, and improvements can be made by using a brighter source of light. Examples of spoken words are given in Figures 11, 12, 13.

An interesting observation which I have made from the study of a large number of such records is that when the same person repeats the same word several times, details of the articulation, as shown by the record, are not identically reproduced, and furthermore, what is perhaps even more striking, when the sound is reproduced from the record, visible differences in the definition on the film do not make any appreciable difference in the ease with which the reproduced sound may be interpreted.

Reproduction of Sound from the Film Records

For the purpose of reproducing the sound, the arrangements shown in Figure 14 were used. The light from a suitable source (the electric arc) was concentrated upon a slit S and an image of the slit was produced at the point F, the light then falling upon a selenium cell in circuit with a battery and telephone receiver in the usual way. The film bearing the sound-record passes through the beam at the point F, where the bright-line image of the slit S is parallel to the markings upon the film.

It is found that there is no need to make a positive film from the original negative film, the negative

film itself serves quite well. This means that the phase of the vibrations may be reversed throughout, without any effect upon the sound reproduction.

duced sounds, as in the case of the ordinary gramophone.

The most remarkable observation of all, however, is that considerable variations in the width

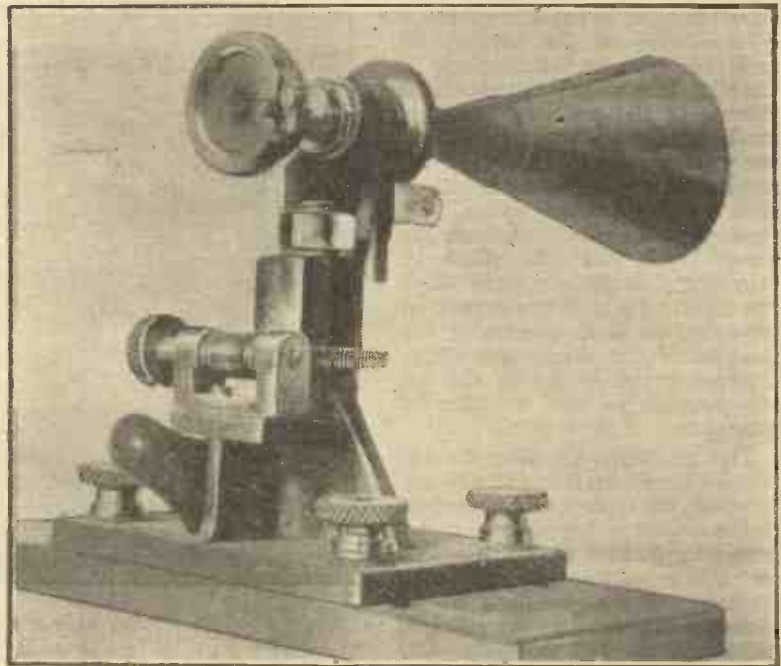

Fig. 9.—The sound-trumpet and diaphragm. Note the small mirror attached to the stylus-arm of diaphragm.

Secondly, it is quite unnecessary to take special precautions so as to secure that the opacity shall be proportional to the intensity of the light which was originally incident upon the film: it is apparently quite sufficient that the main frequency-characteristics shall be represented by suitable alternations of opacity.

of the illuminated slit have very little effect upon the articulation of the reproduced sound. For example, when the width of the recording slit was about 0.1 mm, the widening of the reproducing slit up to more than 10 times that amount made very little difference to the faithfulness of the reproduction.

This means that the ear has a remarkable capacity for interpreting sounds, provided that the main characteristics are present, and it is probable that, in speaking, different persons vary very considerably in the details of their articulation, without one being noticeably easier or more difficult to understand than another.

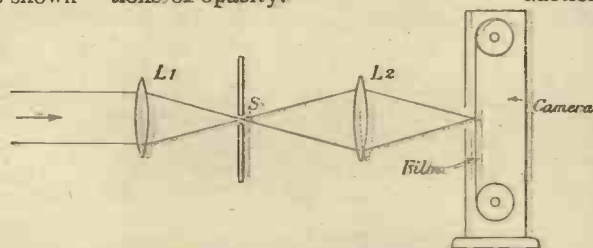

Fig. 10.—Diagram of arrangements for producing film records by means of phonograph.

The velocity of the film in reproduction need not be precisely the same as in recording: any reasonably small difference in the recording and reproducing velocities simply means a difference in pitch of the recorded and of the repro-

"Pictures." of Sound Waves

It is well known that sound-waves in the air are longitudinal, that is to say, the displacement of the air particles when the wave passes is parallel to the direction of propagation of the wave. In the

more usual method of representing or recording sound-waves (for example, by means of a spot of light reflected from a mirror attached to a vibrating diaphragm), the result is indicated by a wavy trace which is, in effect, a *graphical representation* of the rarefactions and compressions taking place in the air. It is true that gramophone records of the ordinary kind are made by the recording of such a wavy trace, but it must be remembered that in the reproduction from a gramophone record, the passage of the needle through the wavy track has the effect of vibrating a diaphragm, from which the resulting sound-waves proceed *normally*, so that eventually the motions of the diaphragm which produce sound-waves in the air are parallel to the direction of propagation of the waves.

The photographic film records which I have been discussing above, however, are quite a new departure in the matter of sound-wave representation, in that they amount to an actual *picture* of the rarefactions and condensations taking place in the air (the wave-length being considerably reduced). Or, to put the matter in another way, the changes of photographic density on the film correspond to the changes of density in the air, and the record of any sound obtained

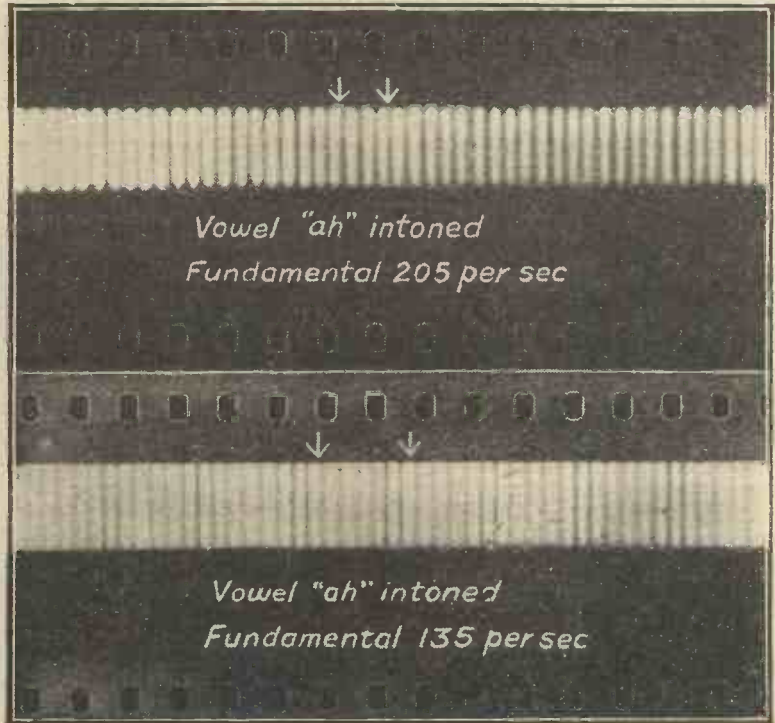

Fig. 11.—A record of vowel sounds.

in this way may be regarded as a condensed instantaneous picture of the succession of compressions and rarefactions in the associated sound-wave.

Some Applications of the Photophone

By running the film at a higher speed when making the record, it is possible to accentuate the details of different speech sounds and to show very clearly the difference between such sounds as, for example, "th" and "z," an application of the method which may perhaps be useful in the study of phonetics.

"Talking Pictures"

It will be seen that this method of recording and reproducing sounds is especially adaptable to the making of "talking pictures," and, so far as I am aware, no previous attempt has been made on these lines to achieve this particular object, although many attempts have been made on other systems, some unsuccessfully and some with a certain measure of success. Whether the "talking picture" will ever become an established institution is open to question, as it is held by many that the public has now become accustomed to the film as the "silent drama." An important practical difficulty in connection with "talking pictures," further-

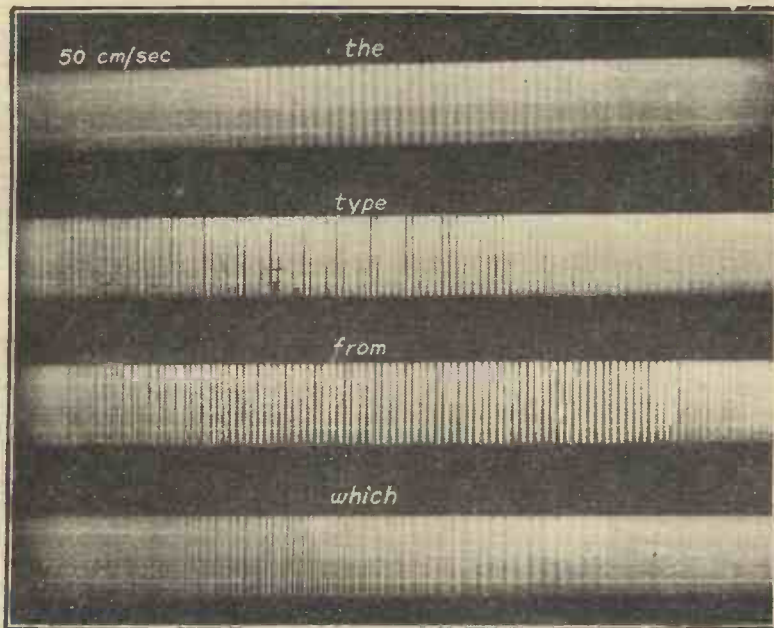

Fig. 12.—A specimen record of spoken words.

more, is the recording of the voices of artists who are obliged, by their movements when acting, to be at considerable and varying distances from the recording apparatus.

Photophone Used as Microphone

I have already mentioned that the speech as reproduced by the photophone transmitter is remarkably faithful to the original; it will be observed that the photophone transmitter and receiver, regarded together as one unit, may be substituted for the microphone in connection with telephony transmission, and it is of interest to note that, for the above reason, a photophone transmitter of my design has been in use in place of the usual microphone for modulating the radio-frequency waves at the Manchester Broadcasting Station for several months past and has been found very successful.

NOTE.—Many readers will be interested by the explanation given by Professor Rankine of the experiments conducted at Manchester recently. The photophone transmissions can usually be recognised by the extremely sharp and clear-cut quality of their reproduction.

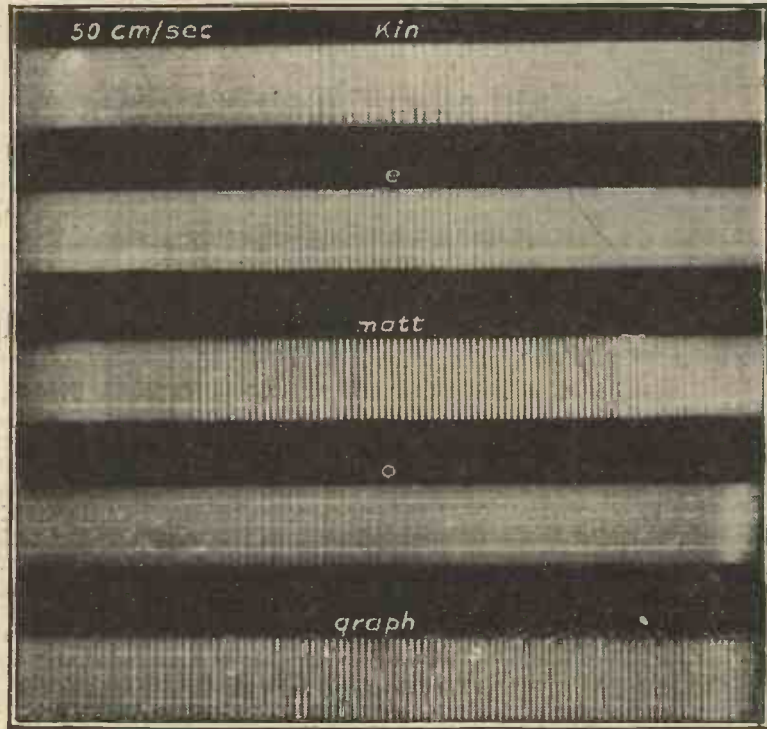

Fig. 13.—The word "kinematograph" recorded.

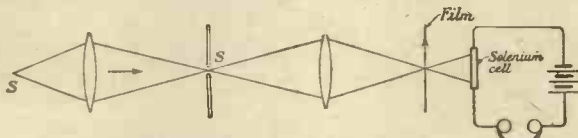

Fig. 14.—Experimental arrangements for the reproduction of the sound from the film-record.

POSITIVE AND NEGATIVE

ONE is apt, sometimes, to overlook the fact that electrical potential, like position and time, is purely relative and that just as height is measured up or down from a reference datum so is electrical potential positive or negative in relation to an arbitrary zero.

In the case of the thermionic valve it has become customary to regard the negative end of the filament as being at zero potential—i.e. to make this our datum—and in receiving valves the anode or plate is maintained at a potential some 50 volts positive in relation to the filament. In other words, the anode, on account of the

"HT" battery, carries a considerable excess of positive electricity. The grid carries a small excess of positive or negative electricity, and is relatively positive or negative as the case may be.

Now the incandescent filament emits particles of negative electricity or electrons, just as boiling water emits steam, and as these travel to relatively positive points, when free to do so, most of them will flow to the anode where a continuous neutralisation of positive electricity gives rise to a make-up current from the HT battery.

One end of the incandescent filament is positive in relation to the other, hence there is a con-

stant, though much smaller, stream of electrons from the negative end through the vacuum to the positive end; and if the grid is positive in relation to the filament, it will receive its stream of electrons also. If the grid is negative in relation to the positive end of the filament, but positive in relation to the negative end, it will still collect electrons, for there remains a portion of the filament that is relatively negative.

When we say that electrons travel to relatively positive points, we are referring to points relatively positive in the circuit, for although the individual electrons may be said to have potential—this varies during its travels according to its position in the circuit. In practice it is with the circuit therefore that we are concerned when we talk of electrical potential or voltage. Thus, when free to do so, an electron will flow from a point in a circuit that is highly positive to a point that is more highly positive, just as it will flow from a point that is negative to one that is positive, and it may be noted that in so doing it will reduce its own (negative) potential.

H. McC.



"A Compact Broadcasting Receiving Set"

To the Editor of MODERN WIRELESS

SIR,—I was very much interested in Mr. Redpath's article anent the above subject in your March issue. In studying the pros and cons of same, it struck me that—in the case of amateurs doing their own turning—the jig would not, in all probability, receive the attention it ought to, owing to its transient utility. No doubt, care would be taken to follow every detail regarding stator and rotor; but if the jig does not receive similar attention good results cannot be achieved, for, unless the convex portion of the jig is true to gauge, it is impossible for the whole coil of wire to receive due pressure when transferring to stator.

I think Mr. Redpath laid too much stress upon coating the coil with shellac when upon jig; if the stator has efficient coatings, I cannot see the necessity of laying it thick upon the coil before being transferred, in fact, it lends itself to trapping the unwary into *fixing* the coil to jig—especially if they wait for any length of time.

In turning my jig I made one exception to the drawings, I substituted, in place of disc, a piece of wood (as shown in photo) turned to fit and come through the hole on the outside of stator, which eliminated any chance of the jig slipping

out of place when pressing same in stator. I had no trouble whatever with the transfer. I gave the stator a coat of shellac, which dried almost immediately; followed by a second one; I then coated the coil on jig with shellac and transferred without delay. Upon releasing the jig it came away without any trouble whatever, leaving the coil spick and span in stator.

Regarding Mr. Wilkes' letter in

Indoor Aerial in Sweden

To the Editor of MODERN WIRELESS

DEAR SIR,—I suppose it might interest you to hear that in Gothenburg (Sweden), 650 miles from London, I can hear the broadcasting from Marconi House (2LO), London, with only an indoor aerial. This aerial is very simple, fixed in a temporary way round the ceiling in my room, and consists of a single 7-stranded bare copper wire forming a simple rectangle with sides of about 3½ and 4½ yards respectively. The aerial is not insulated from the walls but is carried on ordinary iron hooks fixed in the walls. The earth consists of the lead-covering on the telephone cable for my private telephone.

In fact I have not fixed up anything outside my room.

The receiver is a home-made 4-valve set, using one H.F. and 2 note magnifiers, and reaction from the detector-valve to the aerial inductance. No secondary circuit is used.

The set is built from a diagram by J. Scott-Taggart, published in the March number of MODERN WIRELESS, but I have found it more efficient to make some small alterations.

Yours sincerely,

G. H. D'AILLY, D.Sc.
Berzeliigatan 20 III, Gothenburg,
Sweden.

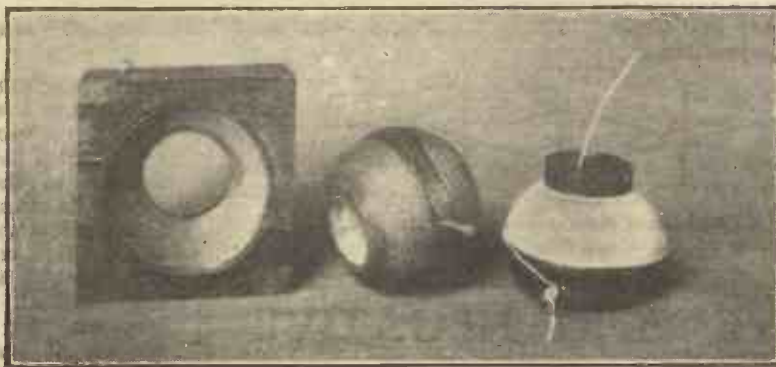

Mr. Mitchell's method of fixing a Stator Winding.

your May issue. Either one or both points mentioned above—re making jig and shellacking coil on jig—were the cause of your correspondent's failure: his jig was not "turned in unison" with his stator, or else the coil was fixed to the jig through being too liberally soaked with shellac—instead of transferring it became a case of "transfixing," with odds on the "fixing." There is no need to resort to the paper stunt if Mr. Redpath's drawing is adhered to, taking due care not too liberally to coat the coil with shellac whilst on jig.

H. MITCHELL,
East Barkwith, Lincoln.

The ST 100 Circuit

To the Editor of MODERN WIRELESS

SIR,—It may interest some of your readers to know that with your ST 100 I get 2 LO up here on a loud speaker.

I have just finished listening-in to the opera "Siegfried," Act 3, and previous to using ST 100 I used a 1 H.F., 2 L.F., with reaction on tuned anode, receiver, which was no better than the 2-valve on London and not so good on Glasgow!

I would strongly recommend all your readers, in this district anyway, to try it.—Yours, etc.,

Dundee. W. M. SMITH.

To the Editor of MODERN WIRELESS

SIR,—Please accept my congratulations on your ST 100 circuit.

I built one up yesterday from spare "junk" in my workshop, and immediately I switched the filaments on, 2 LO was heard. I had evidently got the positions of the variable condensers right. I shall give the circuit a good try out so that I can demonstrate to the club members. I did not want to upset my cabinet set, and it might interest you to know that C1 was a .0015 variable, and C2 was a .0003 variable. Perhaps with standard parts I could get still better results, as everything was home-made, including the L.F. transformers. I tuned in all the Broadcasting stations from Glasgow to London, and I should say it was about the strength of a 3-valve set using reaction. This was on the phones, as I had not sufficient strength for loud-speaker work. Of course, my nearest station is nearly 100 miles away. I have a very efficient aerial, as I can get F.L.'s music on any evening of the week with a Hertzite crystal.

Wishing you and MODERN WIRELESS every success.—Yours, etc.,

Isle of Wight. A. BALL.

Re Variometers

To the Editor of MODERN WIRELESS

SIR,—I made up two variometers of the type Mr. Redpath described in the March issue of MODERN WIRELESS, one with 22 and one with 24 s.w.g. The rotors were a little larger than the diameter given, and were 3 in. and 3½ in. respectively, turned up from ebonite balls. The 3 in. just

picked up in tune 2 LO at zero and Croydon at 140°. The 3½ in. wave-length was too long, so I took off some of the windings and now pick up 2 LO at 10° and Croydon at 110°, both tuning in very well. They are built up a little differently from Mr. Redpath's and are complete in themselves.—Yours, etc.,

N.21. S. M. SPRATLEY.

A Schools Radio Society

To the Editor of MODERN WIRELESS

SIR,—Many readers may be aware that I have for many years past been interested in the development of radio in schools. From figures which I have at hand I find that during the past two years there has been a rapid growth in this direction which is far greater than any of us ever anticipated. Many of us in the teaching profession feel the time has come when we should put our house in order. There is a tendency in many schools to fix up a receiving set and then listen to pretty music. We feel that no good purpose can be served educationally by adopting this practice, and if radio is to stay in the school it must have greater utility. To accomplish this is not a difficulty, provided schools organise themselves and exchange ideas.

Nearly every day I receive communications from schools asking for the best means to obtain a permit in order to carry out various experiments. The general tone of the correspondence seems to suggest that special facilities should be granted to educational institutions to meet their exceptional needs. There are strong grounds for this, for we must bear in mind that it is from the schools that we shall obtain our future scientists and research workers. Consequently the natural characteristic of curiosity which every child possesses should not be retarded by hard-and-fast rules and regulations, but rather encouraged. In my own experience I have found numerous boys who have made receiving sets out of the most unbelievable things, and showing great ingenuity in their efforts. Yet owing to permit restrictions they are unable to use their sets. However, we must bear in mind that the P.M.G. has no easy task at the present time. It is apparent that he does not wish to handicap anyone, but instead to create

an orderly and undisturbing system of radio reception. When we consider the difficulties with which he is beset, we should give him the sympathy which he deserves in his almost insurmountable task. We should not grouse, but instead assist and offer him suggestions when an opportunity permits. This can only be done through some organised authority such as a society.

At a recent meeting of the Radio Society of Great Britain, of which Dr. Eccles, F.R.S., is President, it was decided to form a "Schools Radio Society" which will be a branch and under the guidance of the parent society. The idea is that every school will have a club of its own which will be under the authority of the School Radio Society in London, from which it will be able to obtain advice and assistance.

Some of the aims which it hopes to achieve are:—

(1) To foster the growth of radio in schools and to gain the interest and assistance of school governors, managers and local educational authorities.

(2) To obtain greater facilities and safeguard the interest of all schools possessing radio.

(3) To gain greater freedom in school experimental work and demonstrations which are necessary to explain certain radio phenomena.

(4) To organise the teaching of wireless in schools and to formulate a suitable and educationally useful syllabus.

(5) To organise inter-school tests, experiments and competitions.

(6) To found a radio scholarship.

(7) To obtain greater facilities for pupils to construct their own apparatus.

(8) To arrange lectures and demonstrations at various schools, by the leading authorities on radio.

These are only a few of the many aims which the society have in view, and further suggestions will be very welcome.

Any school which is interested in the scheme or desires to join the society, will they please communicate with the Organising Secretary,

Mr. R. J. HIBBERD,
Grayswood Mount,
Haslemere, Surrey,

who will give them every assistance possible. A stamped addressed envelope will ensure a speedy reply.—Yours, etc., R. J. HIBBERD.

More Appreciations of the ST 100.
To the Editor of MODERN WIRELESS
SIR,—Allow me to congratulate you on the excellence of circuit ST 100.

Yours, etc.,
T. ROBERTSON.
Southwark, S.E.17.

To the Editor of MODERN WIRELESS

SIR,—I have spent some considerable time on this circuit and I confess the results are excellent. Congratulations on the circuit.

Yours, etc.,
W. ISON.
Salisbury.

To the Editor of MODERN WIRELESS

SIR,—I have pleasure in reporting to you my first tests with circuit ST 100 as detailed in MODERN WIRELESS.

Newcastle is much too loud for the head 'phones, and the Brown loud-speaker (large) was easily operated.

Later London was tuned in 310 miles away, and the opera, "Il Pagliacci" received perfectly. Too loud to be comfortable on the 'phones and just audible enough to be readable in a 12ft. square room on the loud-speaker. This performance of the set astonished me and bears excellent testimony to the sensitivity of this circuit.

Yours, etc.,
F. A. DEOME.
Wooler, Northumberland.

To the Editor of MODERN WIRELESS

SIR,—I was much interested in the account of ST 100 in the June

number of MODERN WIRELESS, so finding I had all the necessary parts except the valve panels by me, I put two valve holders on a strip of ebonite and wired it up yesterday afternoon. With Burndep't concert coil No. 4 as L₁'s and a 75 of the same make as L₂, and 85 volts HT, I tuned in 2 LO at 5.30 and got the loudest, clearest

To the Editor of MODERN WIRELESS

SIR,—With reference to circuit ST 100 and your request for reports on same, I have pleasure in informing you that I have been able to hear successfully The Hague, Radio la Paris and Eiffel Tower, Paris concerts, and, of course, 2 LO. Have also picked up Croydon, Lympne, and LeBourget and local amateurs.

I am using two solenoid coils (I believe this is the correct term for single-layer coils on card former), one for A.T.I. and one for anode; these are fitted with sliders and obviate the necessity of using large capacity condensers. I have two small variable condensers, about .0001, which are quite O.K. for fine tuning.

Yours, etc.,
H. E. W.
Forest Gate, E.7.

To the Editor of MODERN WIRELESS

SIR,—Many thanks for the wonderful ST 100 circuit. Several of our members have tried it and find it simply marvelous. We are able to work a loud speaker easily from the first valve alone, without having to use the second valve at all.

Also, long life and prosperity to your new magazine — *Wireless*

Weekly. All of our members speak highly of it, and are giving up the older wireless journals and taking it in instead.

We look forward to every number.

Yours, etc.,
H. F. SOUTH,
Hon. Sec., Woolwich Radio Society,
Eltham, S.E.9.

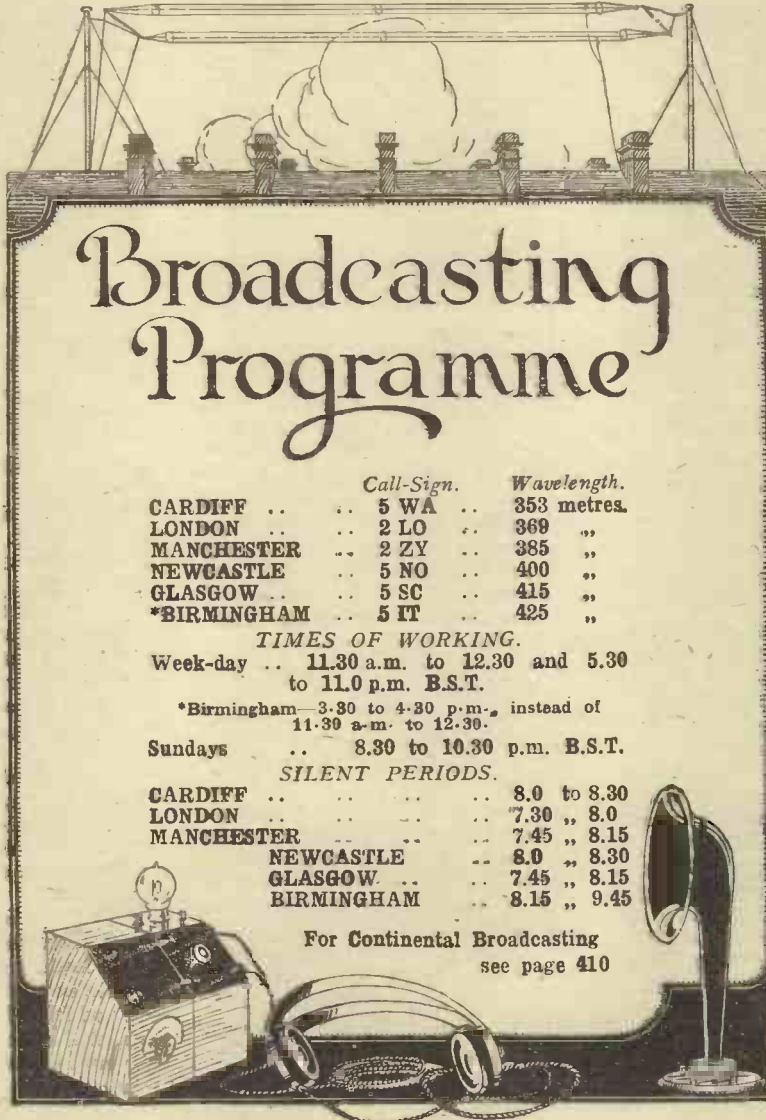

Broadcasting Programme

	Call-Sign.	Wavelength.
CARDIFF	5 WA ..	353 metres.
LONDON	2 LO ..	369 "
MANCHESTER	2 ZY ..	385 "
NEWCASTLE	5 NO ..	400 "
GLASGOW	5 SC ..	415 "
*BIRMINGHAM	5 IT ..	425 "

TIMES OF WORKING.

Week-day .. 11.30 a.m. to 12.30 and 5.30 to 11.0 p.m. B.S.T.

*Birmingham—3.30 to 4.30 p.m., instead of 11.30 a.m. to 12.30.

Sundays .. 8.30 to 10.30 p.m. B.S.T.

SILENT PERIODS.

CARDIFF	8.0 to 8.30
LONDON	7.30 ,, 8.0
MANCHESTER	7.45 ,, 8.15
NEWCASTLE	8.0 ,, 8.30
GLASGOW	7.45 ,, 8.15
BIRMINGHAM	8.15 ,, 9.45

For Continental Broadcasting see page 410

and best telephony I have ever heard.

There was no difficulty in working the set at all. I am now wondering if it is possible to put in a further stage of HF first.

With best wishes.
Yours, etc.,
A. H. ATKIN.
Kensal Rise, N.W.10.

EXPERIMENTS WITH THE ST 100 CIRCUIT.

By JOHN SCOTT-TAGGART, F. Inst.P.

It is proposed in the following article to deal with some miscellaneous points in connection with the ST 100 circuit.

THE simplified arrangement is shown in Fig. 1, which is reproduced from June 13th issue of *Wireless Weekly*. Fig. 2 shows a correct pictorial diagram of the connections to different component parts. In a reflex circuit of this kind, or in fact in any reflex circuit, i.e., one in which valves act in the dual capacity of high and low-frequency amplifiers, self-oscillation at audible frequencies is very commonly experienced. If properly handled, and when using suitable components and values of high-tension voltage and filament currents, the ST 100 is a relatively stable circuit, and personally I have had no trouble, although several different sets have been made to my specifications and have given excellent results.

As several readers, however, have stated that they are troubled by the set oscillating and producing a howling noise, I propose to give some information which may prevent this happening.

In the first place the 100,000 ohms resistance is a very important factor in stabilising the whole circuit, and many experimenters who use home-made resistances or some of the variable grid-leaks at present on the market will have trouble. These resistances, in most cases, do not go down to a sufficiently low value. The resistance may have a value from 20,000 to 100,000 ohms according to individual circumstances. It is not, of course, permissible

to use reaction on the aerial circuit on broadcast wavelengths by coupling the two coils. This tends to make the set howl, although, if the set be properly arranged and handled, reaction may be introduced without any fear of howling. If too much reaction is introduced, the set will oscillate at high frequency and then begin howling at low frequency, and when this happens the reaction should immediately be loosened, when the low frequency oscillation should stop.

Another likely source of trouble is the crystal detector. Make sure that the crystal detector is doing its full duty. If it is a poor crystal, or if signals are very strong in the first place, the absence of the crystal detector will not make very much difference, and signals may be heard

with the crystal point lifted from the crystal. This, of course, should not happen when no reaction is used, but the effect may be obtained when reaction is employed. To adjust the crystal detector it is as well to detune the aerial circuit until signals are very weak, then adjust the crystal detector and retune the aerial circuit. A very light pressure between the spring and the crystal detector may tend to make the set howl. If it is possible to obtain a fairly firm pressure without sacrificing signal strength, the apparatus will remain more stable. Also try reversing the leads to the detector.

To enable the different components, coils,

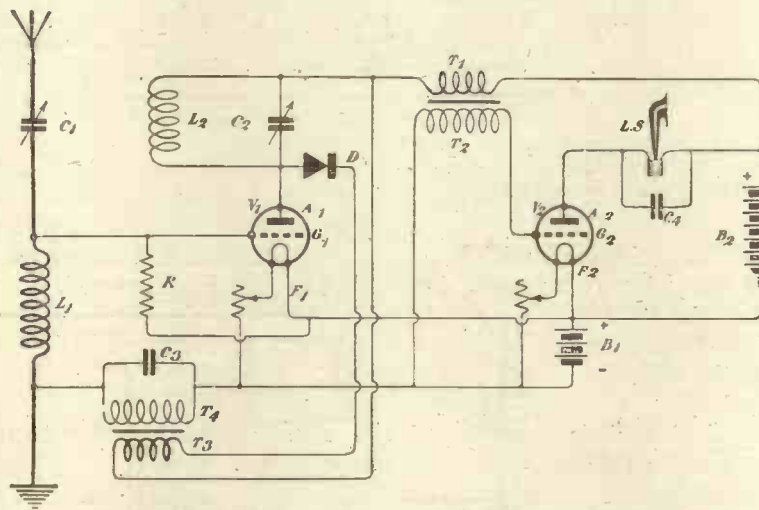

Fig. 1.—Simplified arrangement of the ST 100 circuit.

etc., to be tried out, I would advise the experimenter, if he has any trouble, to wire up the circuit shown in Fig. 3, which is a straightforward arrangement. If first-rate results are obtained with this circuit, the different com-

used there is a greater likelihood of howling owing to the capacity of the human body in relation to earth and different parts of the receiver. This particularly applies when certain types of phones are used. If you fear that

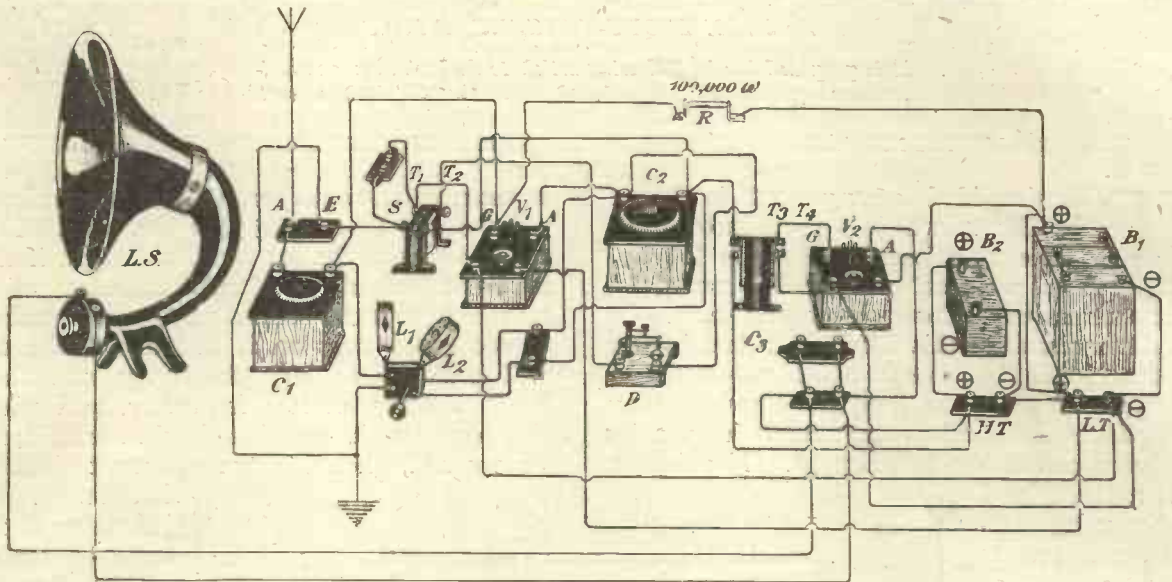

Fig. 2.—Pictorial diagram of the connection of parts.

ponents may be wired up for the ST 100 circuit with the addition of the extra transformer and resistance.

If very loud results are obtained with the Fig. 3 circuit, there is obviously no point in trying to convert it to the ST 100, as it is only possible to obtain a certain signal strength with two valves on loud signals.

I have found that the circuit is not very effective on long distance signals. This is because there is only one stage of high-frequency amplification. Its chief use seems to be in obtaining very loud results when within 50 miles of a broadcasting station.

The voltage of the high-tension battery is an important factor, and 100 volts is recommended. The actual high-tension battery I employed is one supplied by Messrs. A. H. Hunt Limited and is of the Hellesen type. It is preferably shunted by a 1 microfarad condenser.

The question of whether phones or a loud speaker is employed is also one of considerable importance. I find that when phones are

low frequency howls are due to this trouble, try placing the phones on a sheet of dry paper on the table. If the howl persists, the source of the trouble lies elsewhere.

The circuit is essentially one for obtaining

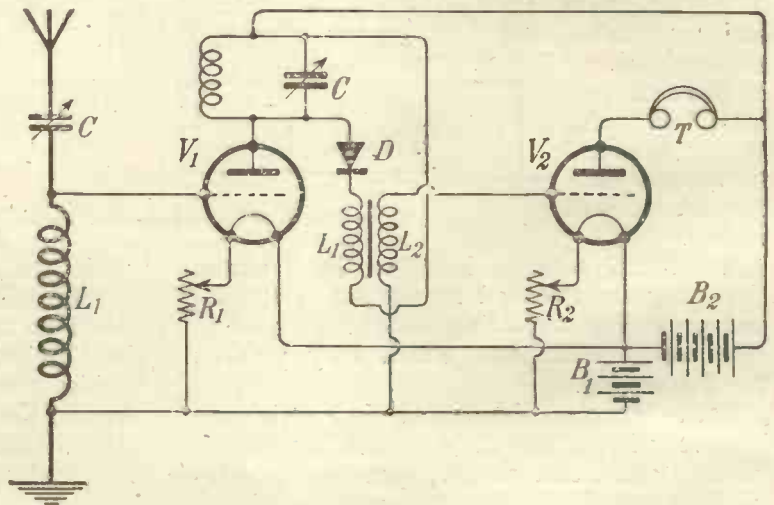

Fig. 3.—A simpler valve and crystal circuit.

results with a loud speaker. One correspondent receives 2LO on a loud speaker at Aberdeen, but this seems exceptional.

Further experiments with the ST 100 circuit have resulted in obtaining even louder results

than before, and a number of highly successful demonstrations have been given.

I find that by applying a negative potential of from 4 to 9 volts on the grids of both valves materially improves the quality of speech and the amplification. Two flash lamp batteries connected in series will be found suitable. An intermediate tapping between the two batteries will enable the experimenter to apply about 4 volts to the grid.

The new circuit in which is incorporated a 1 microfarad condenser across the high-tension battery is shown in Fig. 4, which should be tried by all who have operated this circuit.

Many experimenters will probably find the circuit easier to tune by connecting the variable condenser across the aerial inductance, rather than in series with it.

At the time of going to press, hundreds of letters are coming into the office indicating the success which has attended the use of this circuit, but there are also a number which

indicate that some of our readers are having difficulties. We find that quite a number, who have never made a set before, have commenced with this circuit.

Allow me to assure the readers of MODERN WIRELESS that there is nothing tricky about the circuit or apparatus. Everything works in a perfectly straightforward manner, and no trouble should be experienced by the average experimenter.

Some readers are obviously not using the correct values of inductance for tuning purposes. The aerial inductance should be a No. 25, 35 or 50 Igranic honeycomb coil. The coil in the anode circuit of the valve should be a No. 50 or No. 75 Igranic honeycomb coil and the reaction coil should be a No. 75 Igranic honeycomb coil. Other coils of corresponding value may be employed.

The condenser C_3 across T_4 will have a value which will depend upon the make of transformer. In many cases the condenser may be omitted without making any difference.

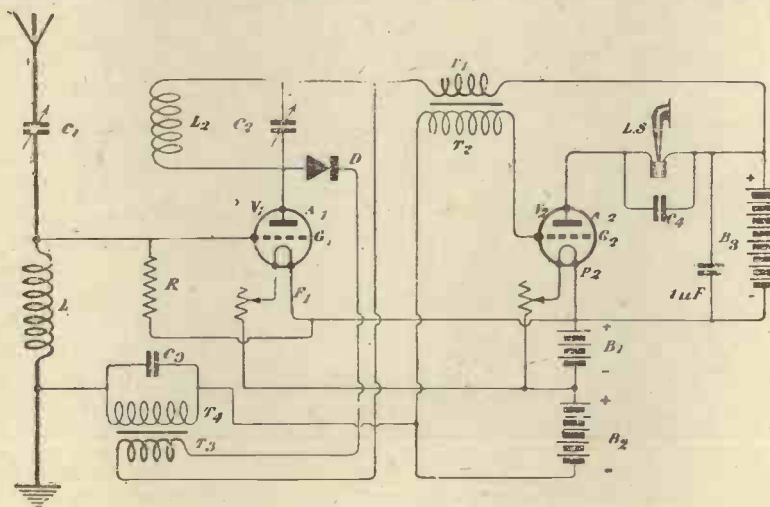
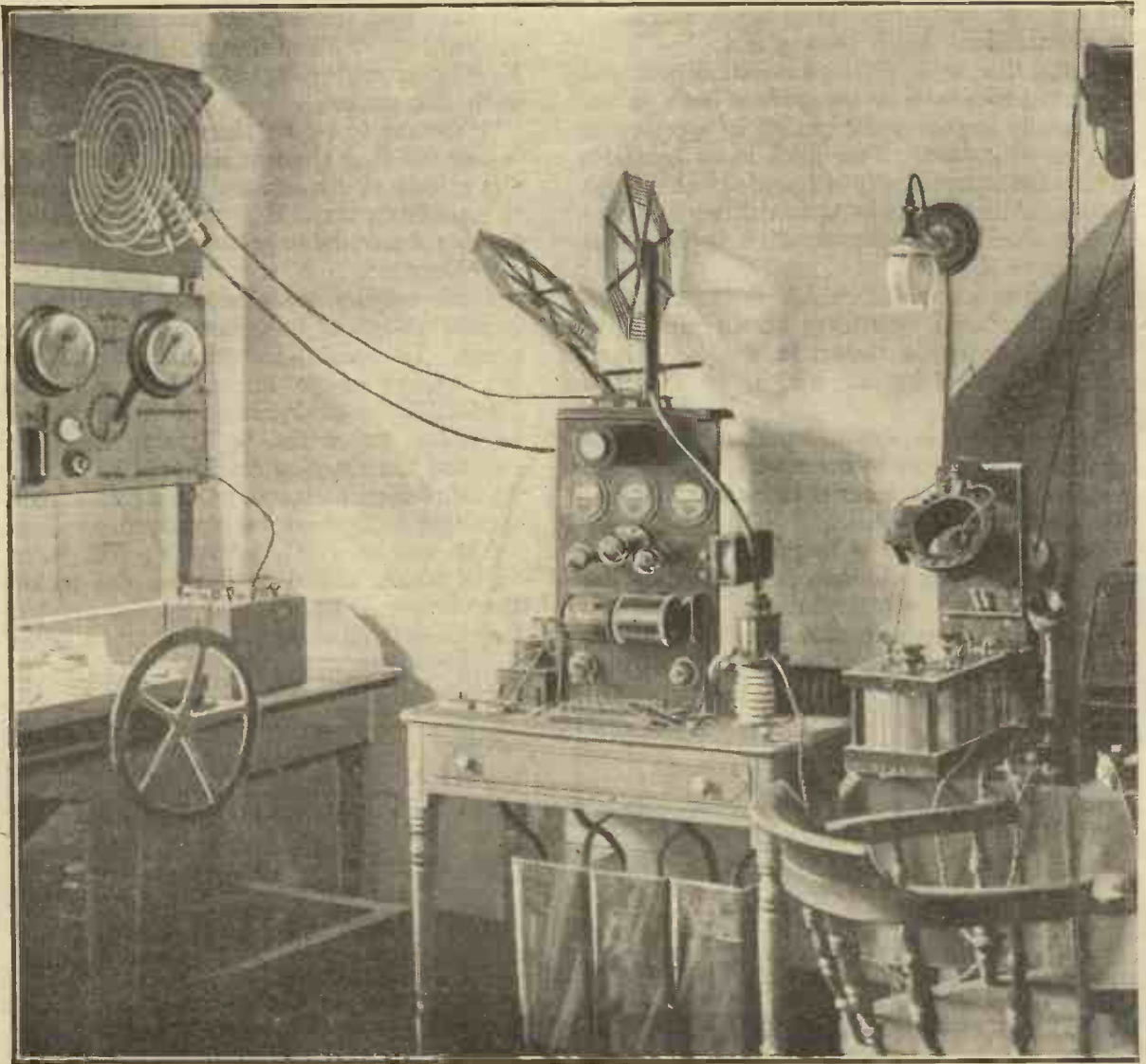

Fig. 4.—A modification of the ST 100.

WHAT AN ENTHUSIAST CAN DO

THE following amusing paragraph appeared in a recent issue of the *Nottingham Evening News*: "In the types of receiving circuits there is no end. The sincere experimenter is continually assembling and dissembling the component parts of his apparatus in his efforts to discover the ideal. The June issue of MODERN WIRELESS describes a super-sensitive two-valve receiver which is called the 'ST 100' Circuit. A local reader of this magazine was so struck with the arrangement that he proceeded forthwith to

build it. He had never previously had occasion to use a crystal, and as this was essential in the make up of 'ST.100' he had to search around for substitutes for the suggested Hertzite, cup and cat's-whisker. He succeeded, by the use of a tiny piece of carborundum, a safety razor blade, and a mouse-trap, in fitting up an excellent crystal combination, and by the aid of these strange make-shifts in the 'ST.100' circuit, picked up 5IT, whose transmissions were heard through a loud-speaker."



"2 DX," the experimental station of Mr. Kenneth Alford, at Camberley, is often heard on the ether after—

THE EXPERIMENTAL

By W. K.

THIS station is situated at Camberley, Surrey, about 30 miles from London, and has been in operation since March, 1919.

The aerial system has undergone several modifications since that date, having been a twin wire, single cage, and finally, a double cage, which has proved very satisfactory for

short wave transmission, having a calculated resistance of about 7 ohm. The cages consist of 4 wires, each 3-19 P.B., spaced 18 in. by bamboo "crosses." The total length of aerial is 50 ft. and the cages are spaced 8 ft. apart by spreaders.

The internal arrangements of the station may be studied by reference to the photograph,

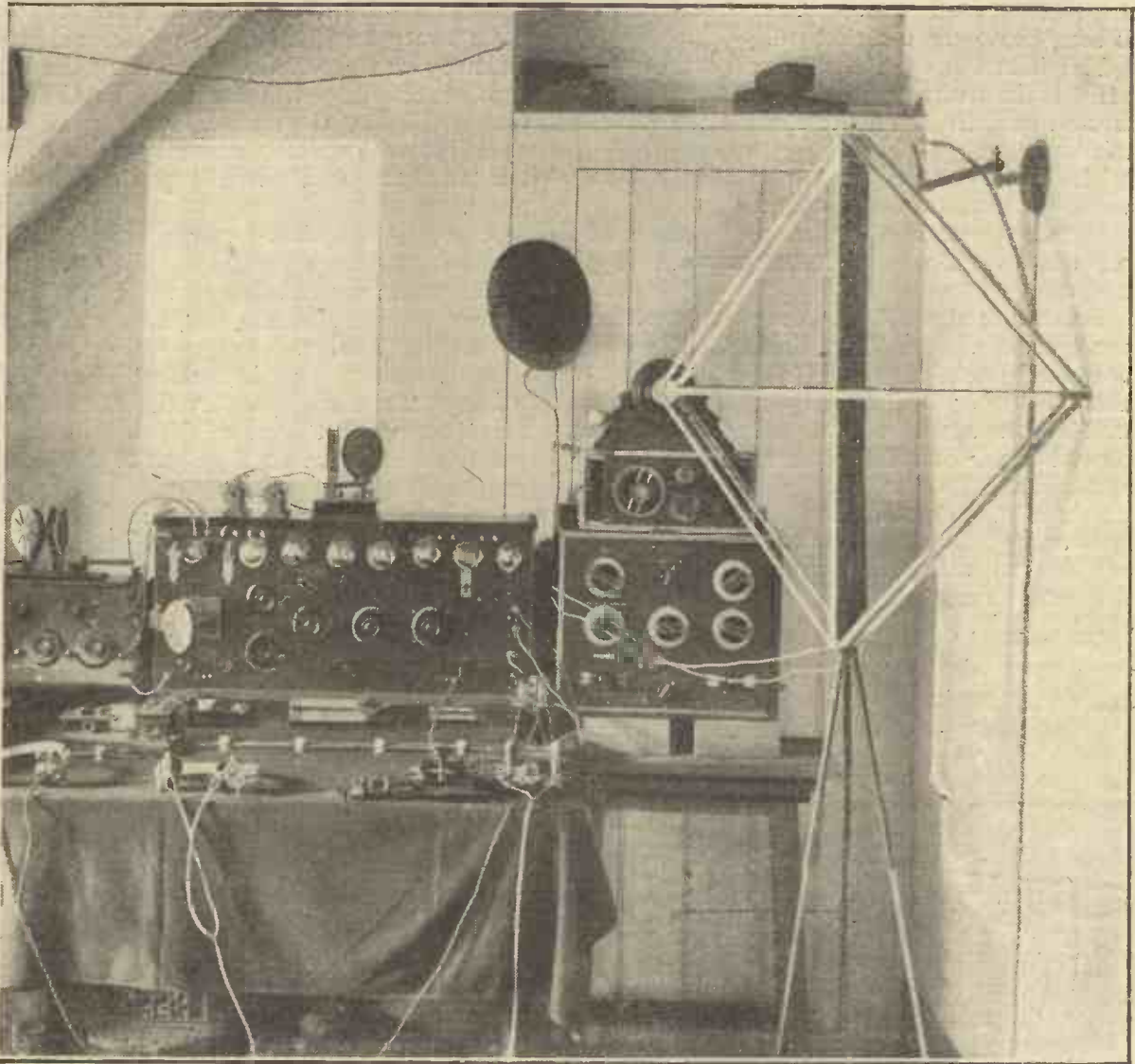

—broadcasting hours. Many experimenters will envy Mr. Alford his 10-valve Armstrong supersonic receiver described below.

STATION 2DX

ALFORD.

or rather the two photographs which were joined together in the centre, as it was not possible to embody the whole apparatus in the field of the camera lens.

On the extreme left is seen the switch-board controlling the charging of 6 volt accumulator batteries—3 large Fuller Block cells being seen beneath the small table.

A $\frac{3}{4}$ -h.p. Stuart gas engine, built in pre-war days from castings, drives a 50 v. 14 a. dynamo, which in turn drives, by means of its fly-wheel pulley, a 150 watt Mackie generator giving 1,500 volts at 100 ma. for telephony and cw. transmission.

On the left centre is seen the transmission panel, above which are the inductances, and

a variometer for fine tuning of the aerial circuits is seen above the switchboard.

The inductance on the lower part of the panel is the tuning for the earth screen, which is used exclusively on the short wave transmissions.

The three meters read respectively 0-10 volts, 1-100 mA., 0-2,000 volts.

With a 50 watt input an aerial current of 2.2 amperes has been obtained on 195 metres.

Further to the right are seen the receiving arrangements. A Telefunken tuner, which is an instrument of superb design and remarkable efficiency; a Gambrell tuner, using their well-known space wound coils which has proved a most useful piece of experimental apparatus, and next, the receiver amplifier, which is built on the principle of the famous Armstrong Supersonic Heterodyne and employs 10 valves, although the long-wave side may be cut out and 2 valves used as an ordinary H.F. and rectifier unit.

This instrument was built at home and has given every satisfaction, though considerable difficulty was experienced in finding the best type of coupling transformer. In the end Gambrell coils, G and H, were used, and gave better results than any other form tried, and are seen on the top of the instrument.

A somewhat elaborate arrangement of L.F. feed-back has been applied to this instrument, both on the long and short-wave side. These transformers, condensers, etc., are seen beneath the Gambrell tuner.

In operation, the instrument shows surprisingly little difference in the efficiency of reception whether used on the main aerial or the two-foot frame on the right of the photograph.

Behind the frame is a German Lorenz tuner which has been frequently used for long wave selective work, but has been retained more as an example of remarkable technical design than general utility.

A LINK IN THE IMPERIAL SCHEME.

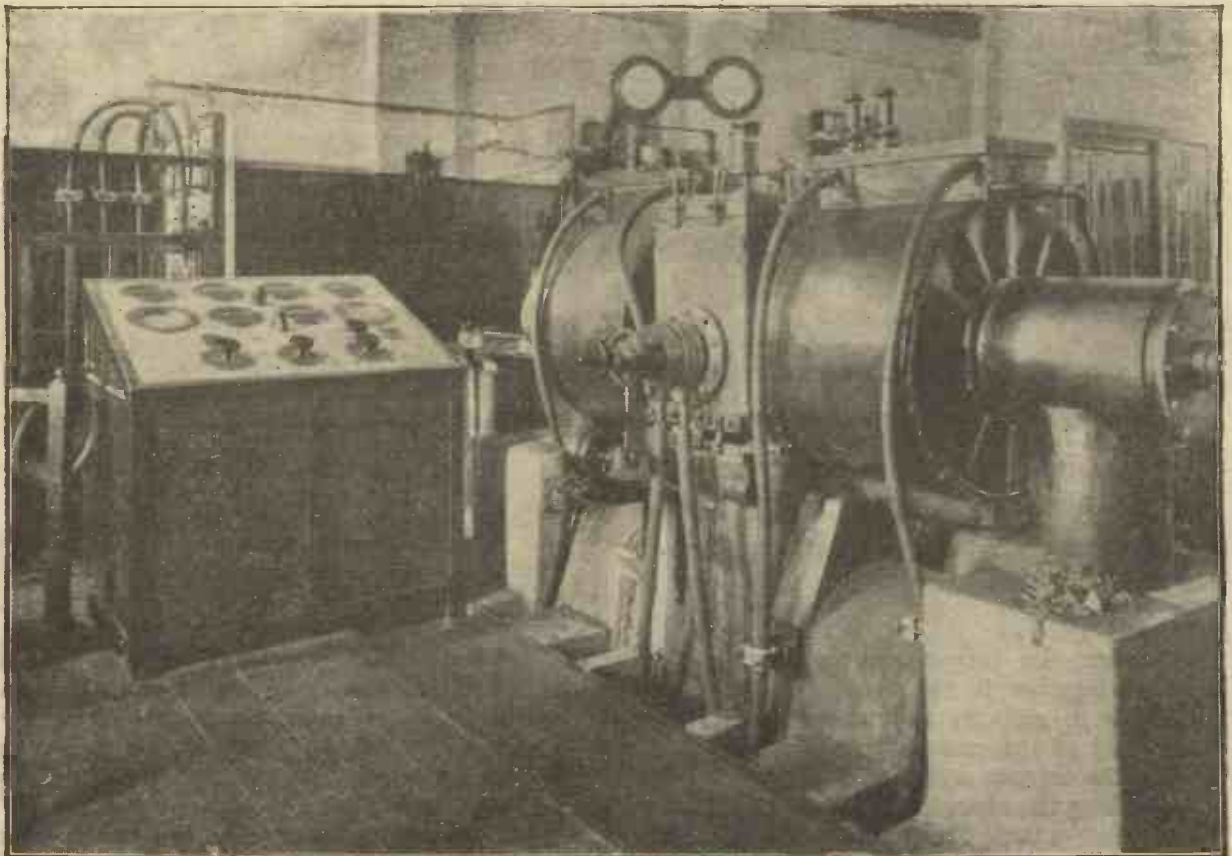

In the arc room of the Abu Zabal Radio Station near Cairo. This station is in constant direct communication with Leasfield, Oxfordshire. The transmitting equipment consists of Elwell Arcs,

A PORTABLE BROADCAST RECEIVER

By G. P. KENDALL, B.Sc., Staff Editor

Full instructions will be found in this article for making a very neat and efficient set of a type suitable for the constructor who has had a little experience. It employs one of the "reflex" circuits which are rapidly becoming very popular where compactness is required.

ONE often feels the need of a really compact portable set, whether for use during short absences from home, or for giving small demonstrations, and the design of such an instrument is quite an interesting matter.

Before proceeding to consider the details of design it is necessary to settle one important question: is the set required to work a loud-speaker, or will good signals in the phones suffice? In the case of the receiver to be described in this article it was decided that good, clear head-phone signals would serve, in order that the set might be made as compact and light as possible and its attendant batteries reduced in size. In passing, it may be remarked that the present writer is no great believer in so-called portable sets which are designed to operate a loud-speaker, partly because the latter is in itself bulky and far from portable (unless efficiency is sacrificed) and partly because the number of valves usually required is such as to demand an accumulator of considerable size and weight. This latter objection can, no doubt, be removed by the use of dull-emitters, but the high price of these valves places them out of the reach of many.

Design of the Set

The first requirement of a portable set is that it must be capable of giving good results upon poor aerials and in unfavourable locations. A certain amount of high-frequency amplification is therefore essential, but it should preferably

severely limit the number of valves which it is permissible to use, and makes it essential to work those actually employed in such a way as to get the absolute maximum of efficiency from them. A further consequence of the limitation of battery size is that one cannot

waste a valve upon rectification, and a crystal is therefore necessary.

Finally, of course, the size and weight of the set must be reduced to a minimum by careful design and by choosing component parts of as small size as is consistent with efficiency. The components used in the set under discussion were chosen because their dimensions and general design were such as best fitted into the scheme of the receiver, and it will therefore be necessary to specify the make of most of the parts.

Taking all these factors into account, it seems that some form of dual amplification or

"reflex" circuit should be adopted for portable sets, in order that each valve may serve the double purpose of amplifying at both high and low frequency. If dull-emitter valves, or an accumulator of fair size, can be used, no doubt ST100 is the ideal circuit, but it was assumed in the present case that neither of these



Fig. 1.—The complete receiver.

be limited to one stage in order to comply with the second requirement, which is simplicity of operation.

Thirdly, the amount of accessory paraphernalia must be as small as possible, and the filament accumulator, must be of small size. This latter condition, of course,

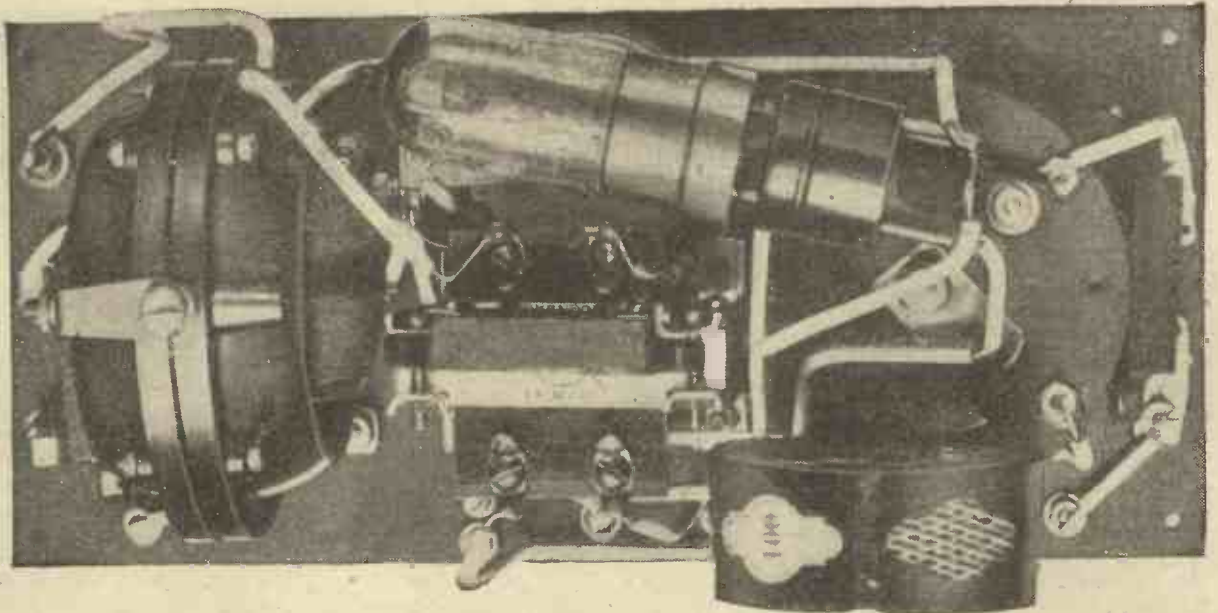

Fig. 2.—The underside of the panel. Note the position of the Cossor valve.

was allowable, and therefore a single-valve and crystal circuit was chosen. This also enabled the set to be reduced in size and weight.

The question of the inclusion of a compartment for the telephones was decided in the negative, since it is difficult to design one in which they will not rattle about and sustain damage when travelling.

The Circuit

The circuit of the receiver is shown in Fig. 3, from which it will be seen that one of the standard single-valve reflex circuits is used.

The valve *V* first amplifies the incoming oscillations at high-frequency and reproduces them in a magnified form in the tuned circuit L_1C_3 . They are then rectified by the crystal detector, *D*, and passed through the primary of the intervalve transformer T_1T_2 . From the secondary of the transformer they are applied between grid and filament of the valve and once more amplified, at low-frequency this time, and so are made audible in the telephones *T*.

S is simply a single-pole change-

over switch whose function is to connect the grid circuit either direct to the negative side of the filament or to the negative end of the filament rheostat, in which latter position a negative bias of about two volts is applied to the grid when a six-volt accumulator is used. Experiments should be made to ascertain which position of the switch gives the loudest and clearest signals, since this depends upon the type of valve used and the voltage of the H.T. battery. As a

Values of Components

Success with reflex circuits depends in large measure upon the use of suitable values for certain of the components, and the writer has devoted a considerable amount of time to determining experimentally the optimum values for those used in this receiver. These values will be given, and the reader is most strongly advised to adhere to them closely, especially in the case of the fixed condensers, which should be of some reliable make. (Those used in the set photographed were made by the Dubilier Co.)

The condenser C_2 (Fig. 3) is one of the most critical in the circuit, for the reason that while it must be large enough to by-pass H.F. pulses, it must not be so large as to reduce appreciably the L.F. voltages from the secondary of the transformer T_1T_2 . Experiments were made in circuits in which the two effects could be separated, and it was found that the efficiency of the

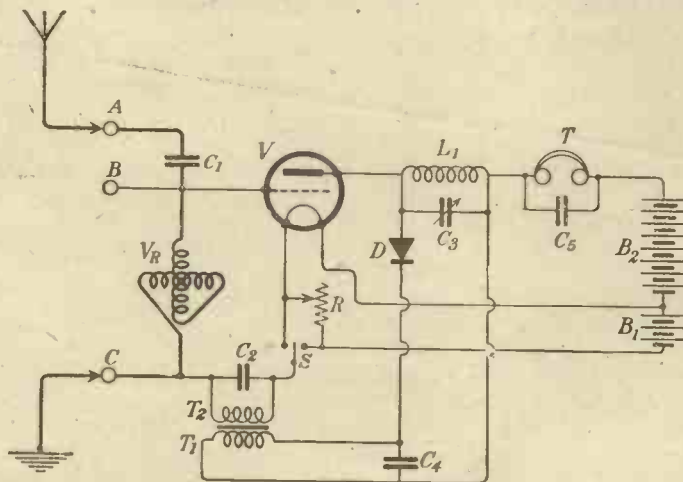

Fig. 3.—The circuit of the receiver.

rule, the best results will be obtained with the switch in the right-hand position, and a fairly high plate voltage.

H.F. circuit improved as the capacity was increased up to about .0067 μ F, further increases having little effect. On the other hand

in the L.F. circuit signal strength fell off considerably when the capacity was raised above $.0005 \mu\text{F}$, although it was not much affected by smaller values. A capacity of $.0005 \mu\text{F}$ was therefore chosen as being a good compromise. This should not be regarded as an absolutely universal value for all types of intervalve transformers, since different makes may require different by-pass capacities, but it should suit most of the well-known standard makes. (That used in the

it may effectively by-pass the H.F. component of the plate current across the phones. It should not be less than $.002 \mu\text{F}$ capacity, and may be larger still with advantage, say, $.003 \mu\text{F}$ or $.004 \mu\text{F}$.

The filament battery B_1 should be of 6 volts, to enable the switch S to be usefully employed, and about 20 ampere-hours capacity, for portability's sake.

The plate battery B_2 must be adjusted in voltage to suit the valve used, but a general rule should

Although this variometer gives the required wave-length variation, and, indeed, covers other waves as well, it was found desirable to include in the set a small fixed condenser which can be connected in series when the set is used on large aeriels. The effect of this condenser is to enable one to use a larger value of inductance on a given wave-length, thereby applying greater variations of potential to the valve and producing stronger signals.

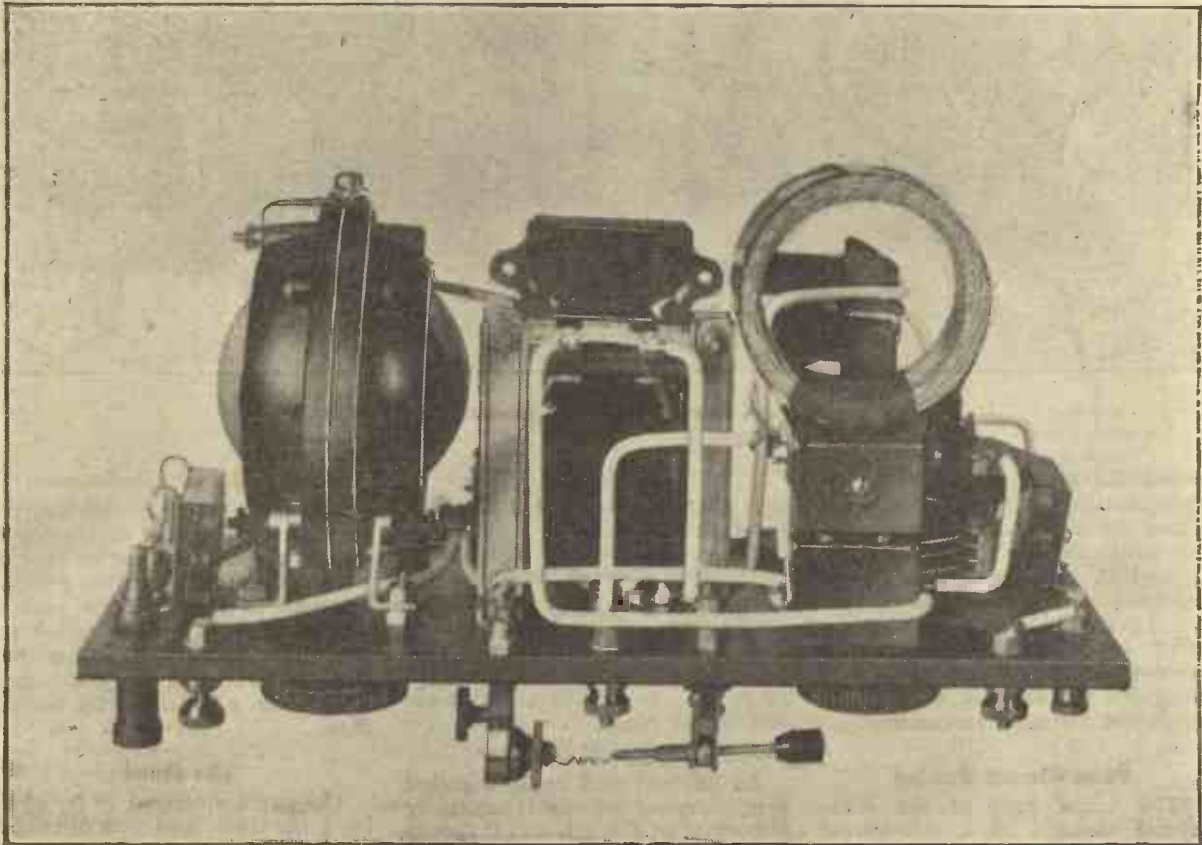

Fig. 4.—A side view of the components beneath the panel.

experiments and incorporated in the set was of Igranic manufacture.)

The condenser C_4 is not critical, and may be of about $.001 \mu\text{F}$ to $.002 \mu\text{F}$. In the Igranic transformer, of course, the necessary capacity between the primary terminals is already provided, and it is unnecessary to include a separate condenser to perform the functions of C_4 . No such condenser, therefore, appears in the photographs.

The condenser C_5 must be of quite large capacity, in order that

be made that a fairly high value should be chosen, to enable the valve to perform its dual function satisfactorily.

The values of the other components will be given under subsequent headings.

Aerial Tuning Arrangements

The main aerial tuning device is a McClelland variometer, which is found to cover the broadcast wave-length band in a quite satisfactory manner.

The condenser in question is marked C_1 in Fig. 3, and should have a capacity of $.0003 \mu\text{F}$. A plug and socket arrangement is used to bring this condenser into circuit when required, as is indicated in Fig. 2. A, B and C are sockets into which plugs connected to aerial and earth can be inserted. The earth plug is placed in socket C, while the aerial is inserted in A or B according to whether it is desired to have C_1 in or out of circuit. When the set is used upon a small

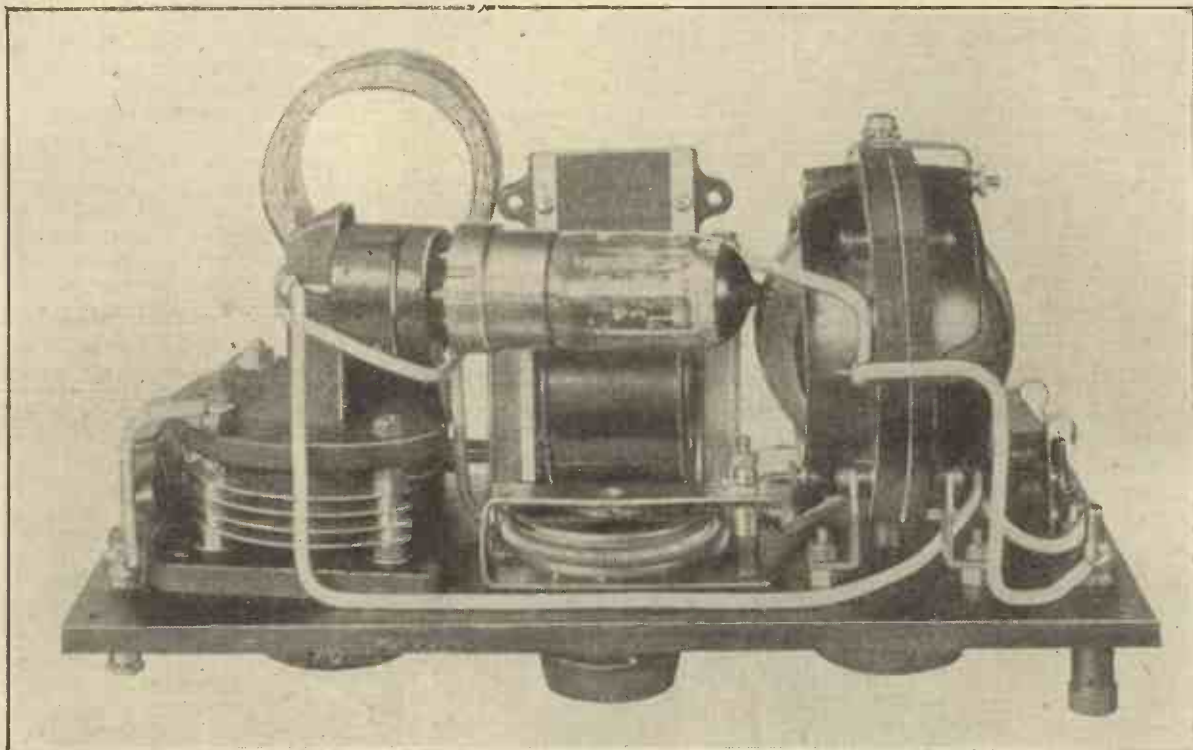

Fig. 5.—The underside of the panel seen from the front.

aerial the plug is inserted in B, thus cutting out the condenser. Three terminals could, of course, be substituted for the sockets A, B and C, and this course is recommended. In this, as in all other parts of the receiver, care has been taken to specify standard components which can readily be obtained by anyone desiring to construct a similar instrument.

Plate Circuit Tuning

The tuned part of the plate circuit consists of a duo-lateral or other plug-in coil, L_1 , and the variable condenser C_3 . The latter should have a maximum capacity of $.0001\mu F$, which with a suitable coil covers the broadcast band comfortably.

For the reception of the London and Cardiff stations the coil L_1 may be a Burndept or Igranic No. 75, while, for Birmingham a No. 100 is suitable. To cover the whole wave-length band with maximum efficiency, however, a coil of 90 turns is required, which may be obtained either by winding it oneself upon a $1\frac{1}{2}$ inch diameter former with No. 22 c.c. wire (see

"M. W." for May, p. 252), or by stripping ten turns off a standard 100-turn coil. This latter expedient was actually adopted in the case of the coil shown in the photographs, the operation being very easily performed with no other tools than a pair of scissors to cut the wire and a screwdriver to remove the band which attaches the coil to its plug.

The Crystal Detector

An efficient and easily-adjusted type of crystal detector is extremely important in this set, and it should preferably have a screw adjustment of the pressure upon the crystal.

The one actually included in the set is the Perikon detector from a Mark III. tuner which has been converted into one of the cat-whisker type while retaining its screw adjustment. Failing such a detector, one of the ordinary sets of parts can be obtained and fitted to the panel in the position shown in Fig. 1. The exact positions of the detector parts are not marked on the plan of the panel (Fig. 7), for the reason that different detectors will naturally vary in their dimensions.

The Filament Resistance

It is necessary to specify the type of filament rheostat employed, in order that the constructor may be certain of its fitting in the position assigned to it. The one used is of the "C-H" type, in which the resistance element revolves and the contact arm is stationary. These are advertised by various firms.

The Panel

The panel measures 10 by $4\frac{1}{2}$ in. by $\frac{1}{4}$ in. thick, and was obtained cut to size and rubbed down matt for the sum of 7s. 6d., from one of the firms who undertake such work for the experimenter.

The positions of the more important holes are indicated in Fig. 7, which also shows where to fasten a number of the components to the panel.

The Fixed Condensers

Since the capacities of most of the condensers are critical it is important that good ones of guaranteed value should be obtained. It is not wise to take risks in dual amplification circuits.

The Case

The box in which the set is enclosed is the case of a Disposals Board Fullerphone which the writer chanced to have in his possession. A suitable case with a similar lid to that illustrated can be obtained for a reasonable sum from one of the firms who do such work to order. If it is not desired to carry the set about much the lid can be omitted, and the instrument then forms a very neat and compact broadcast receiver for general use.

The essential dimensions of the box are that it should fit the panel, and that its depth under the panel should be $5\frac{1}{2}$ inches. Since the valve is shut up inside the box and may become over-warm in use, a few small ventilation holes should be drilled in the sides of the box. In order to make it easier to see when the valve is a light valve window (see last month's "New Ideas") may be placed in the front.

Construction

The construction of the set is chiefly a matter of drilling holes in the panel and attaching the components to it by means of screws, but there are perhaps one or two points requiring a little explanation.

The first step is to drill the holes whose positions are marked in Fig. 7 and attach the following components to the panel: the variometer

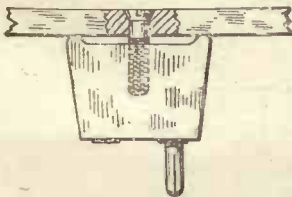

Fig. 6.—Showing the method of attaching the coil socket to the panel.

(whose spindle passes through hole No. 10), the variable condenser (hole No. 9), and the filament resistance (hole No. 11).

These parts are most easily fitted by placing their spindles through the appropriate holes in the panel

and marking through the screw holes in the components the positions of the securing screws. This can be done quite easily with a scribe or a large darning needle. These three components being attached, the single-pole two-way switch can be fitted and the L.F. transformer placed in position, and the holes for its securing screws marked through its four feet.

The coil L₁ is mounted upon the under side of the panel by plugging it into a socket, which consists of

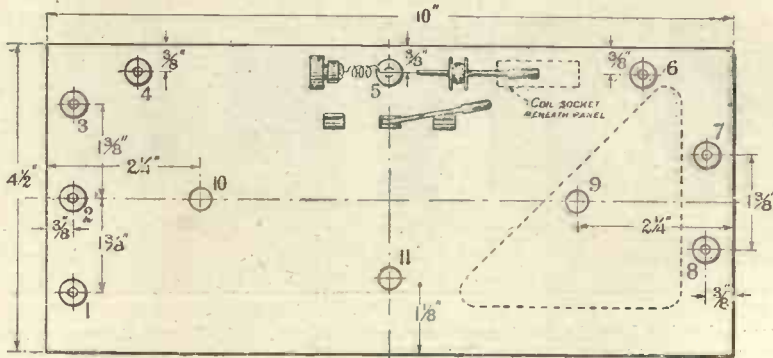

Fig. 7.—Plan of the panel.

an ordinary coil plug attached to the panel by means of a 3 B.A. screw half an inch long, as shown in Fig. 6. To be able to attach this socket in the correct position it is necessary to place the variable condenser in the oblique position indicated by the dotted outline of its triangular ebonite top plate in Fig. 7.

The method of mounting the valve holder is not, perhaps, quite obvious from the photographs. It is supported in the position shown by an ebonite bracket whose base is attached to the bottom-plate of the variable condenser, near the centre, in order to clear the duo-lateral coil. An easier construction which is recommended to anyone making this set is shown in Fig. 8, which illustrates a bracket made of brass strip $\frac{1}{4}$ inch wide and $\frac{1}{16}$ inch thick. It should be bent and drilled as shown and screwed to the ebonite bottom-plate of the condenser, care being taken that only one pin of the valve socket touches the brass. A little care should be taken to place the valve socket in such a position that the valve clears the other components: this should be plain from the photographs. In this connection it may be mentioned that there is only room in the set for one of the tubular valves, such

as the Cossor P¹ (high-frequency amplifying type), Ora, or A.R.

3, 2, and 1 are terminals corresponding to the sockets A, B, and C, while 4, 5 and 6 are the battery terminals: 4 is the L.T. negative, 5 the L.T. positive and H.T. negative, and 6 the H.T. positive. 7 and 8 are, of course, the telephone terminals.

The condensers C₁ and C₂ are attached by having their tags soldered directly to the terminals 2 and 3, 7 and 8 respectively, the tags being bent at right angles so that the condensers assume the edgewise position seen in Fig. 5. C₂ is attached similarly to the secondary terminals of the transformer, or rather to the projecting ends of the connecting wires which are soldered to those terminals.

Wiring

The actual connections of the components are shown in Fig. 9, which should prove helpful when it comes to wiring-up the set.

The connections should be made with a fairly stiff gauge of wire, such as No. 18 or 20, preferably tinned, and should be sleeved with systoflex. The writer often adopts the convention of using a different colour of systoflex for each circuit, but this is a refinement which may not appeal to the average experimenter.

Care should be taken to separate the wiring, keeping it well spaced

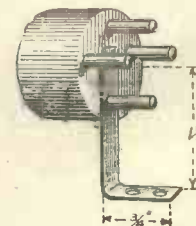

Fig. 8.—The bracket supporting the valve holder.

out, to reduce undesired inter-action effects.

It is worth noting, also, that the three wires from the single-pole change-over switch S should be attached before the L.F. transformer is screwed to the panel, since the

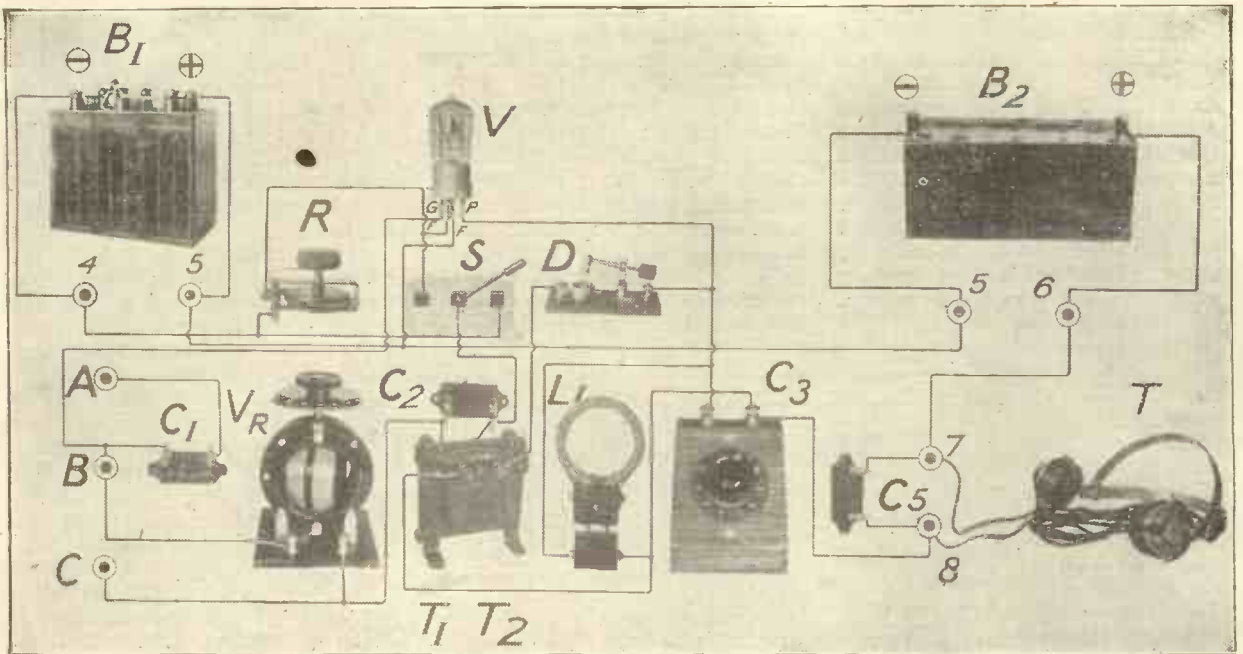

Fig. 9.—Wiring diagram, showing how the components are connected up. A, B and C are the aerial and earth terminals (see Fig. 3), while 4 and 5 are the LT, 5 and 6 the HT, and 7 and 8 the telephone terminals. Note.—The terminal 5 is shown in two places in this diagram merely for the sake of clearness. Actually only one is used, as in Fig. 7.

position of the latter is such as to prevent access to the switch once it is in place.

Results Obtained

Considering that this set contains no intentional reaction whatever, its performance is decidedly good.

Tuning is extremely sharp, and the amplification given is surprising to those accustomed to use their valves for only a single purpose.

Upon a "Ducon" aerial in an unfavourable situation at a distance of five miles from 2LO the signals are almost up to loud-

speaker strength, while upon an indoor aerial only seven feet in length at the same distance good strong signals are produced in the phones. Upon a good outdoor aerial at a distance of 15 miles the set operates a Violina loud-speaker successfully.

IMPORTANT ANNOUNCEMENT.

On JULY 18 will be published a
SPECIAL SUMMER NUMBER
of our companion journal,

THE WIRELESS WEEKLY.

Every Experimenter should obtain a copy.

This issue will contain the first description of a remarkably successful circuit and set for Broadcast reception. On no account should you miss this number.

ORDER YOUR COPY before July 7. This is absolutely essential

SOME EXPERIMENTS WITH AERIALS AND EARTHS

By PERCY W. HARRIS, Staff Editor.

While a great number of amateurs occupy themselves with general experiments for the improvements of transmitters and receivers, few seem to give much attention to the important question of aerials and earths. Much research is waiting to be done on receiving aerials and earth connections, and in this article some interesting results of preliminary experiments on earthing methods are given.

General Arrangements

FOR about two years the present writer used for receiving an aerial about 50 feet long and 20 feet high, with two wires separated by a space of six feet. The actual receiving instruments were, and still are, situated within two feet of the window, and the earth connection was made to a rising water-pipe immediately adjacent to the apparatus. Connection to this pipe was by heavily insulated flexible wire, the earth end soldered to the pipe itself. Notwithstanding its small elevation this aerial gave excellent results, probably because it ran entirely over level grass. No perceptible directional effects were noticed, and it is doubtful whether such small aerials have any, except where the length is greatly in excess of the height. The down lead was kept well away from the wall of the house, to prevent losses in this quarter.

With the object of testing aerial and earth connections of different types a new 35 foot steel mast was ordered, together with new aerial wire and insulators.

The old twenty foot mast, simply a "disposals" aeroplane spar, was very strong but extremely light, and was taken down and from it were cut two eight-foot spreaders, 2½ inches in diameter. These weighed only 4½ lb. each. The new aerial was made with 7/20 bare phosphor bronze wire in place of the 7/22 previously used.

In place of the old green "shell" insulators new white porcelain insulators with a large leakage surface and lower self capacity were put in place. Three of these in series were used at the extremities of the horizontal wire, and four where the downlead is held in place. There was no reason for using a fourth at this point, other than the fact that there was one to spare. By using three in series the capacity of the insulators was reduced to a third

of what it would otherwise have been, while the leakage path was increased to a total of about a foot. To keep the ohmic resistance of the aerial as low as possible each single wire runs from the lead-in to the furthest point in

a continuous run without joints. Further, the stay-wires (which are split up with insulators) do not come within the electrical shadow of the aerial. At the house end the downleads run symmetrically downwards at a distance of about eight feet from the wall. The lead-in is then taken diagonally to a hooded lead-in insulator.

Fig. 1 shows the scale of the new aerial and its fittings, the position of the old aerial being shown as a dotted line. The position of the new aerial when lowered from the mast end is also shown, as it was used like this for certain experiments to be described later.

Experiments and Tests

After the old aerial had been lowered, and pending the erection of the new one, some

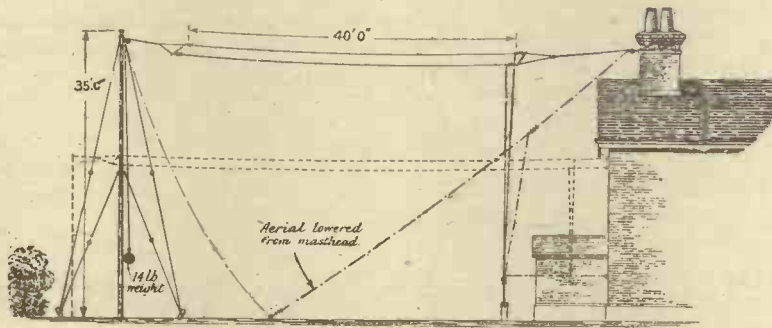

Fig. 1.—The two aerials used in the tests described.

trials of indoor aerials were carried out. The writer has previously tried out a number of different arrangements, such as frames of various sizes, condensers on the electric light wires and wires round the room, and in this particular case the main purpose was to receive the London broadcast concerts without interruption. For this purpose it was found quite sufficient to take a length of No. 26 D.C.C. wire from the instruments once round the picture rail on three sides of the room, using the usual earth connection. The receiving apparatus consisted of one high-frequency valve, with tuned anode coupling, a detector and one or two note magnifiers. The results from the London station were just as good as those obtained on the outside aerial, and one note magnifier was sufficient to operate the loud-speaker. (The distance from 2LO is barely six miles as the crow flies.) Other signals, however, came in very weak, and Birmingham was the only other broadcasting station audible. It should be mentioned here that reaction on the anode coil was used in all tests.

The next experiment was to lengthen the indoor aerial by taking it upstairs. A wire was thereupon taken from the instruments along the picture rail on two sides of the room, out the door, up the staircase (vertically) into the loft and once round the rafters. Fig. 2 shows the arrangement in plan and elevation. Very great improvement was immediately apparent, for Birmingham could be heard on the loud-speaker with three valves, and as loud as desirable on four; Manchester came in clearly in the telephones and at times on the loud-speaker, and Newcastle was also audible. (Cardiff and Glasgow had not then opened.) The Dutch concert at The Hague also came in well, and the results were not greatly inferior to those obtained with the old aerial. This was probably due to the additional height obtained.

As soon as the new aerial was in position tests were made with various stations, showing much better results on some but no improvement on others. Newcastle and The Hague, for example, came in just about the same as before, Manchester and Birmingham were improved, but the 600 metre spark stations were frequently 60 per cent. louder. North Foreland was twice or three times as loud, while Liverpool (Seaforth) was about 50 per cent. better. Amateur 'phone stations on 440 metres were

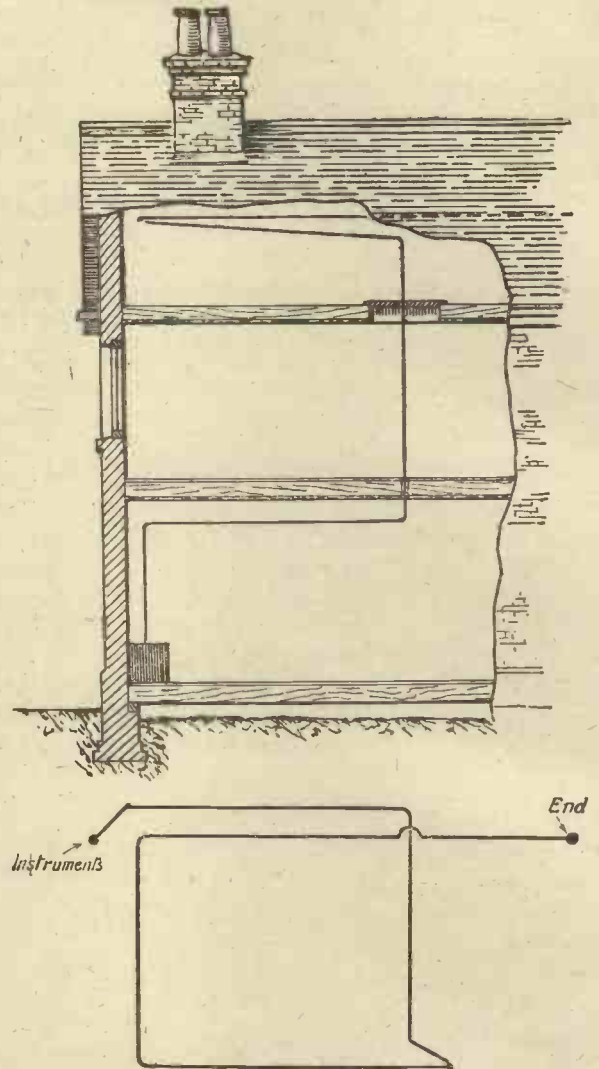

Fig. 2.—Elevation and plan of the indoor aerial.

not greatly improved. It was not expected that the new aerial would give very greatly improved results for broadcasting, as the writer is a believer in long low aerials for such reception. "Mush" from arc station interference and atmospherics were much worse than before.

Owing to the breaking of a stay wire it became necessary to lower the mast end of the aerial, and while the spreader was lying on the ground further reception tests were made. It may surprise some readers to hear that with one spreader lying on the ground it was possible to receive The Hague on a loud-speaker with three valves, and, in fact, the results were very little inferior to those obtained with the old twenty-foot aerial.

Experiments with Earthing Systems

By far the most interesting experiments have been made in connection with the earthing system. It is usually thought that if a good connection can be made to a waterpipe at the point where it enters the ground, and if the instruments are quite close to this point, very satisfactory results can be obtained. The writer was under the impression that very little could be done to improve his earth connection, but he decided to try a new scheme. In particular he has aimed at keeping the aerial and earth resistance as low as possible, even for reception.

had a bearing on the subject, tests were then made among the amateur 'phones on 440 metres and thereabouts. Here results were quite fifty per cent. better on the buried wires even with very strong signals from a station close at hand. Both weak and strong signals on this wave-length were much improved. On 200 metres results were still better and were almost equal to another valve. As previously pointed out, reaction on the aerial was not used in the tests.

Combining the waterpipe earth and the wires outside was tried in each case, but the combination turned out no better than the

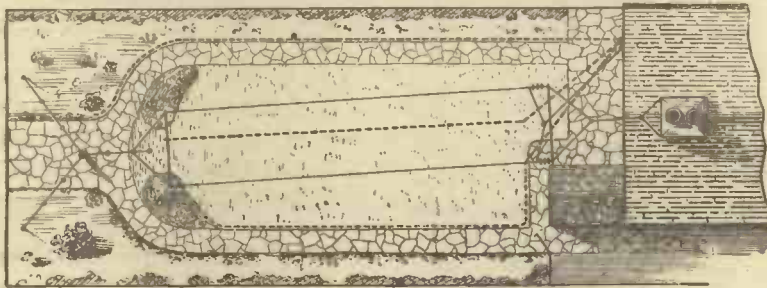

Fig. 3.—Bird's-eye view of the aerial and buried earth wires.

The first new test was to pierce the window frame, fit a second leading-in insulator for the earth wire and then to take three long wires (new aerial wire)—one along each side of the garden and one up the middle of the lawn. These wires were simply laid on the bare ground and were connected through the lead-in insulator to the earth terminal. The waterpipe earth and the wires were then compared on received signals of different wave-lengths, and were found to be as good as one another, no perceptible difference being noticed. The tests were made in pouring rain and also while the ground was dry. No difference was observed in either case.

The wires were now buried in the ground at a depth of about two inches, two wires in the lawn and one in a flower bed. The arrangement of the wires is shown in Fig. 3, the drawing being roughly to scale. Comparisons between the waterpipe earth and the buried wires were then made. It was found that the tuning was not altered, even slightly, by the change.

Of the Dutch concert on Sunday afternoon there was nothing to choose between the two earths, but on 600 metres there was a very marked improvement by using the buried wires. As this suggested that wave-length

better of the two separately. So far no experiments have been made with a counterpoise earth (as such an arrangement is not convenient in the writer's garden), nor has a buried plate been tried. Readers who have buried plate earths may like to try the long wire method. A comparison should prove very interesting.

It is probable that insufficient attention has been given by experimenters to the position of the waterpipes relative to the aerial wires. In most cases the aerial is at the back of the house while the water mains run along the road in front, and the house connection is taken in a direction *away* from the aerial. If the waterpipes run *beneath* the aerial then better results will probably be obtained.

The writer does not claim any special importance for all these experiments. They are put forward merely to suggest to the beginner that it is just as well to try things for oneself, for probably results will vary at different stations. It is not wise to take the "other fellow's" word for too much, and by making experiments such as these new and improved aerial and earth arrangements may easily be found.

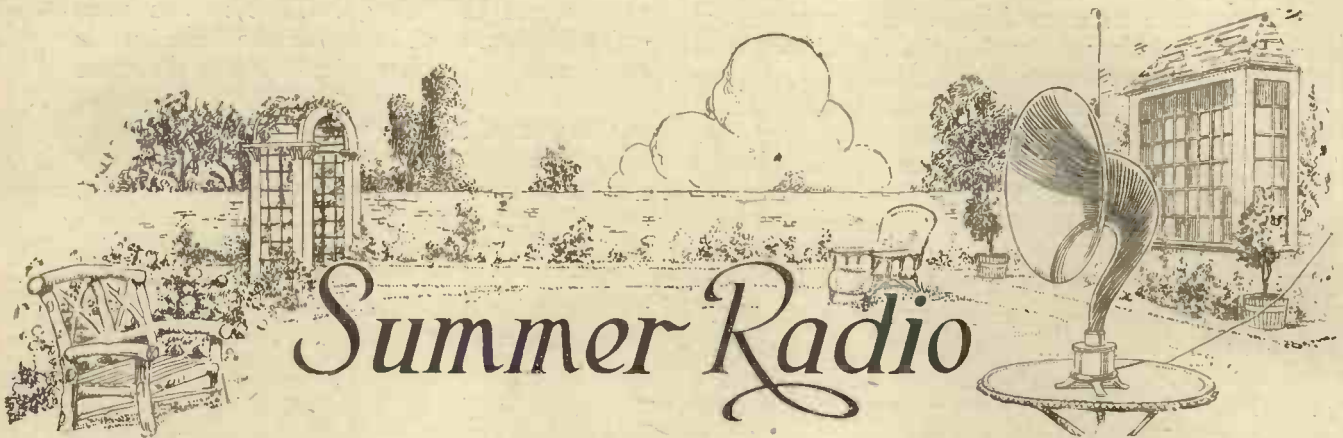

Summer Radio

Radio on the Lawn

WITH the coming of the summer months, many wireless enthusiasts are wondering if it is possible to enjoy their hobby out of doors. Those who have received their first introduction to the art within the last few months are loth to abandon it in the hot weather, yet it would appear to them to be a question of choosing between sitting indoors when it is much nicer outside, and leaving the set dumb and silent.

There is no need to abandon wireless when we go into the garden, neither is it necessary to buy a special set or erect a new aerial. Even the simplest crystal set will serve our purpose. All we need to do is to obtain a sufficient length of electric lighting flex to extend from the instruments to the point where we shall sit, connecting one pair of ends to the telephone terminals and the other to the telephones or loud-speaker.

Garden Wiring

The length of this lead does not seem to matter greatly, for it is not in any part of the circuit where radio-frequency currents flow. If it were, these currents would have ample opportunity to run away to earth through the condenser formed by the lead and the earth, without doing any useful work. As it is, the wire can lay along the grass or the gravel without any detrimental effect, which, of course, is a great convenience.

Readers who are likely to do a great deal of "listening-out," if we may use the term, may find it convenient to instal semi-permanent garden wiring, with a small double-pole

change-over switch from the house to the garden wires. The garden end may be taken to a neat terminal board in a summer-house or other suitable spot.

A Hidden Loud-Speaker Idea

The ultra-imaginative may care to conceal the loud-speaker in the base of a sundial, in which place it would appropriately ring forth the nine o'clock chimes, or discourse on milli-bars.

For some reason or other loud-speakers sound much more natural out-of-doors than do gramophones. These latter are often profoundly disappointing when taken into the open air, whereas a good loud-speaker loses none of its charm on the lawn.

Motor-Car Radio

We have all heard a great deal about portable wireless sets carried in motor-cars, and some readers may wonder whether it is worth while installing such sets in their own Rolls-Royces (or Fords). For everyday use, however, these special sets are hardly satisfactory or economical, for with the tiny aerials allowable a multi-valve set is a necessity. Even with a seven-valve amplifying receiver it is probable that signals would be too weak for a loud-speaker fifty miles away from a broadcasting station, so that unless the occupants are prepared to wear telephones (which is not exactly a comfortable proceeding in such circumstances), the set will be out of commission for a good part of a country ride. Valve replacements, too, are likely to be high on a set so subject to vibration, while

the current consumption is of course quite considerable.

Radio on the Countryside

A far more satisfactory proceeding is to take a set with you in the car and fix up a temporary aerial at some stopping-place. A length of rubber-covered aerial wire can then be slung over the branch of a convenient tree (or even run along a hedge if the broadcasting station is not very far away) and an earth connection made by laying a length of

can be well wrapped in cotton-wool. The set itself should be of robust construction, the joints well soldered, and the condensers so made that the spindles will not swing backwards and forwards with every movement of the car. For current supply to the valve filaments the car battery will serve excellently, thus saving weight that must be carried.

Choosing the Site

When choosing a spot on which to erect the aerial, look for one that is not immediately screened by a sharp rise in ground or trees. Under a cliff you may hear nothing at all, even though the broadcasting station is but ten or twenty miles away. If the aerial is to be long and low, see that the free end points away from the direction in which signals are to be received, and do not expect to pick up the station on the same positions of the aerial condenser and inductance that you are used to at home. The



The portable wireless motor-car of the Marlborough College boys in the field.

bare aerial wire along the ground underneath the aerial. On high ground well away from any screening trees or buildings quite extraordinary results are sometimes obtained, particularly when the aerial can be run out for eighty or a hundred feet, say, between two trees at a height of fifteen or twenty feet.

The Licence Required

A special permit is required if it is desired to take the set away from home, but application to the Post Office should bring a "portable" licence without much delay. It will probably be more readily granted if the applicant is already the holder of an "experimental" licence.

The set used on such country jaunts should preferably contain a stage of high-frequency amplification preceding the detector and whatever note-magnifying valves are used, as this will be a great help in bringing in distant stations. A special box should be made to take the valves, so that these delicate essentials



Bradfield College portable wireless section at a recent outing.

difference in the aerial will considerably affect the readings of these adjustments.

Spares and Sundries

Carry at least one spare valve with you, and if you are not taking a loud-speaker, see that there are enough telephones for the party. Remember, too, that wireless apparatus is particularly susceptible to the effects of damp, and if you lay the set upon the ground, place a waterproof underneath it first. If the set is to be used a great deal out of doors, it is a good plan to paint the underside of the box with paraffin wax, so that the wood may not absorb moisture. "LISTENER-OUT."

"DIRECTIONAL WIRELESS"

By J. ROBINSON, M.B.E., Ph.D., M.Sc., F.Inst.P.

(Continued from p. 328.)

In this article Dr. Robinson discusses one of the most interesting phases of direction-finding work—the errors which arise in taking bearings. A concluding article in our next issue will deal with some possible explanations of why night variations occur.

Classes of Errors

IT is sometimes found that bearings are not easy to determine, and again, when found that they are in error. These errors are of two classes: (a) Those which can be eliminated at the receiving station, and (b) those which are apparently due to phenomena which take place between the transmitting station and the direction finder.

Suitability of Site

It is found sometimes with the simple loop or Bellini-Tosi system that the zeros are bad, and in fact at times it is impossible to get a zero. On occasions it happens that in rotating the loop round through 360° there is no variation of intensity at all, although this occurrence is exceedingly rare.

The location of the direction finding site has a great deal to do with accuracy of determination of bearings. The best site for such a station is on very flat ground and preferably near the coast. Many bad results are obtained by placing the direction finder in hilly country or on land which is surrounded by woods. It is particularly bad, as a rule, to place a direction finder on a cliff. In buildings very erratic results are obtained unless the building is of the correct type for direction finding purposes. There should be as little metal about the building as possible. In ordinary houses trouble arises from the electric light leads, telephone wires, gas pipes and water pipes, and sometimes from metal spouts. The usual type of building to use is a single wooden hut, or where a brick building is used it should be designed specially to have all metal pipes and leads under the ground. Another source of error is a wire fence around the house.

It has been observed on many occasions that when a portable direction finding set is placed under a series of telegraph wires, bearings are

much in error, being deflected towards the line of the telegraph wires. Again, under an open aerial bearings are liable to be very bad, particularly if the aerial is in tune with the direction finder.

It is often impossible to obtain a site fulfilling the best conditions, as, for instance, when it is required to install a direction finder on a ship or on an aeroplane. Under these circumstances the usual procedure is to determine the errors in a similar manner to that employed in the case of the magnetic compass on a ship and apply corrections to each bearing as obtained.

Influence of Amplifier

As the energy picked up by loops is so small and it is necessary to use amplifiers of high power, another possible source of error is introduced. It very often happens that if the loop is disconnected from the amplifier entirely, signals can still be received. This direct action of the waves on an amplifier is fatal for the determination of bearings, and where it is found to exist the amplifier should be put in a screened box.

Antenna Effect

Another source of error is what is known as the antenna effect, which is a cause of bad zeros and of the zeros occasionally not being 180° apart. This is due to the whole of the loop system acting somewhat similarly to an open aerial. It is obvious that by joining the two ends of the loop together and attaching this common junction to one of the terminals of the amplifier, preferably a grid terminal, the other terminal being either connected directly to earth or left isolated, signals will be received. It should be remembered that although this terminal is left isolated there is still some kind of earth connection through the accumulators and accessories which are

necessary for use with the amplifier. These accessories really form a condenser with regard to the earth, and it is well known that a condenser forms an easy path for high frequency currents. When the loop is actually used in its correct manner there are two vertical leads,

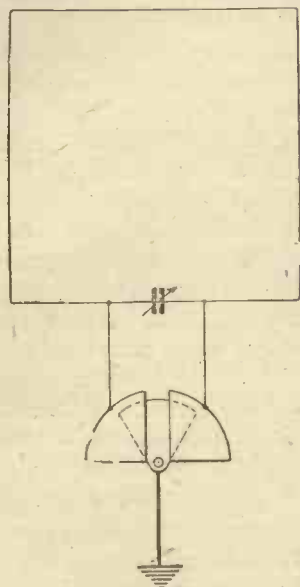

Fig. 21.

How residual antenna effects are balanced out.

and if the open aerial effect in each of these leads is identical, which it should be, and the coil with the amplifiers and all accessories are symmetrically attached to the loop, the two antenna effects should balance out, and we should be left with the pure loop effect. Hence we reach another essential condition for accurate direction finding, that of symmetry in the direction finder. The symmetry of the loop is usually obtained because the condenser is most conveniently connected into the loop in the middle of the bottom limb. This, however, is not sufficient, as the two terminals of the condenser are connected to two different parts of the amplifier, and it is these connections which produce a considerable portion of the asymmetry, the capacity to earth being so often dissimilar through the two paths. For instance, one of the terminals is sometimes directly connected to the accumulators, which are of a large bulk, and being usually placed near to the ground thus account for a fairly large capacity to earth. The other terminal is connected to the grid of the first valve, the capacity to earth of which, by devious routes, is generally smaller than that through the accumulator. This shows that it is preferable to use coupled circuits rather than to connect the loop directly to the amplifier, and in this case it is preferable to use the transformer with its primary in two halves as was shown in Fig. 8. (MODERN WIRELESS, Vol. I., No. 2.)

Certain experimentalists have gone to the trouble of determining the various capacities to earth, even through the telephones and the

operator to earth, and of adding identical capacities to the other side of the condensers; but this method is laborious and will probably be variable. The best method for eliminating any residual antenna effect after all questions of symmetry have been attended to is to provide a particular type of condenser which has three plates, two fixed plates and one variable, so that by moving the variable plate the capacities of the two fixed plates are altered in opposite directions. The two fixed plates are joined respectively to the terminals of the tuning condenser and the variable plate is earthed, Fig. 21; thus by moving the variable plate the capacity to earth of the two limbs of the loop can be varied at will, and any residual antenna effect can be balanced out. For trial of this method, if such a three plate condenser is not available, two variable condensers can be used, the variable plates being electrically joined together and earthed, as shown in Fig. 22; but this is not so convenient to operate, and may lead to all sorts of trouble.

The test for when the antenna effect has been entirely eliminated is when one can obtain an absolute zero on the strongest possible station, and when the two zeros so obtained are exactly 180° apart.

Uni-Directional Systems of Direction Finding.

It has been seen that the antenna effect

tends to make the ordinary direction finder asymmetrical in so far as it makes the angle between the zeros differ from 180°. By attempting to increase the antenna effect the zeros can be brought nearer and nearer together on one side until they actually coincide, in which case there is only one zero in 360°. Consider the combination of a simple loop and an open

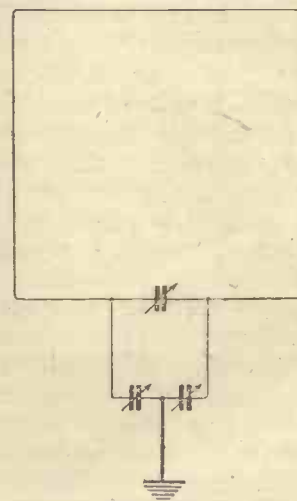

Fig. 22.

Another method of balancing out.

aerial as illustrated in Fig. 23. Let us take the case of an electro-magnetic wave arriving from the direction T. It will be obvious that any given state of the wave will strike the limb A of the loop before it strikes

the open aerial C, or the other limb B. There is, therefore, a difference in phase between the electro-motive forces induced in the three vertical wires, this difference between A and B causing, as we have already seen, an oscillatory current to flow round the loop A, B. The

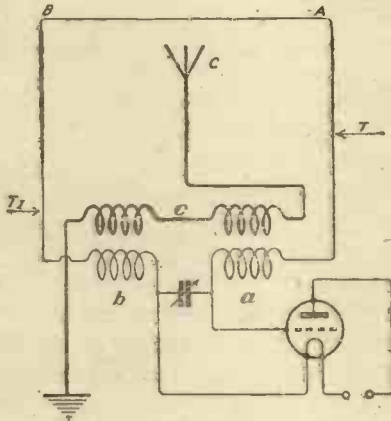

Fig. 23.
Combination of loop and open aerial.

current set up in the open aerial C is caused to interact with the current oscillating round the loop by means of the coupling existing between inductances c and ab. Now, the phase of the electro-motive force in C is behind the phase of that in A for an incoming wave T, but it is in front of that in B. Had the direction of the wave been T_1 , however, although the phase of C at any instant would still be half-way between that of A and B, the order of the difference would be reversed, the phase of C now following on B and leading on A. It should now be obvious that, for the same state of the wave passing the aerial system, while the direction of the current in C remains the same, the direction of the current round the loop will depend entirely on the direction from which the wave is proceeding, the current in C therefore helping the loop current for a wave in one direction and opposing it for a wave in the opposite direction. The effect of this on the signal strength as the loop is rotated is to fill in, as it were, the zero on one side while not affecting it on the other, *i.e.*, only one zero is obtained for a rotation of 360° .

This definite condition is only obtained when the amplitude of the antenna effect is equal to the amplitude of the loop effect and when the phases of the two effects are correct. In order to do this in a practical manner, one may rely on the actual antenna effect of the loop or one may use an actual open aerial for this purpose as described above. There are the two effects

to consider, (a) the loop effect, the amplitude of which varies as one rotates the loop, (b) the antenna effect, which must remain constant as the loop is rotated. A method of using a single loop so that the antenna effect of the loop itself can be superimposed on the loop effect is shown in Fig. 24.

The Bellini-Tosi system has been adapted in this way. It should be pointed out that when using the uni-directional system one zero only is obtained in 360° . This zero cannot be very accurately determined, and it is merely used to indicate on which side of the direction finding station the actual bearing should be taken. Accurate determinations are made on the ordinary simple loop, the uni-directional arrangements being switched out. It must also be understood that the actual direction of an incoming wave can only be obtained with a uni-directional system as above, provided the uni-directional indications of the system have been previously calibrated by reference to a transmitting station whose position in relation to the direction finder is definitely known.

Night Variations

We have discussed the principal sources of error which are liable to occur at the receiving

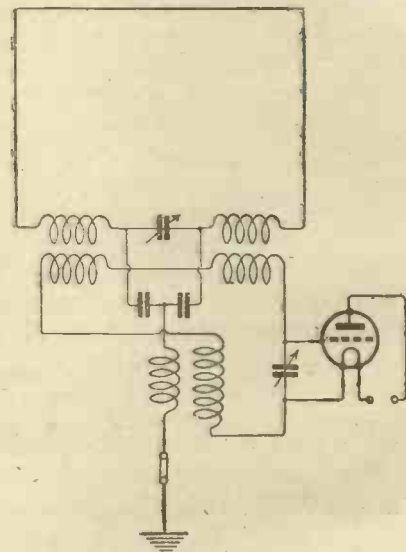

Fig. 24.
Method of utilising antenna effect of loop.

station, and will now pass on to an example of the kind of errors which are apparently due to effects taking place between the transmitting station and the direction finder. When one attempts to take bearings over land, particularly over mountainous country and at

distances greater than, say, 100 miles, bearings are liable to suffer great variations, especially by night. These errors are thus often called night variations. Such errors may be of the order of 10° or 20°, or sometimes more, and the causes have not yet been absolutely determined. When night variations are present another effect is often noticed, and that is that the zeros are bad. It is under such circumstances that the effect has been noticed of the signal strength remaining constant through the whole 360°. Again, when the effect is bad, the bearings sometimes wander very quickly. These variations depend to some extent on wave-length. It is fortunate, however, that in the cases where bearings are most urgently required these variations are seldom received—that is, at sea over comparatively short distances.

General Experiences

Considerable use is now made of direction finding for the purpose of navigation, and navigators are placing more and more reliance on the use of wireless bearings for this purpose. It can confidently be hoped that in the near future wireless navigation will be one of the principal means of navigation, both on the sea and in the air. At sea at the present time wireless navigation is used in two different ways.

(a) The direction finding stations are placed on the coast, and whenever a ship wishes to obtain its position, it transmits a message which is picked up by these stations, who send the bearings to a central station, where the position of the ship is worked out and re-transmitted to it.

(b) The direction finding apparatus is on the ship itself. In this case bearings can be obtained on the ship of any known wireless transmitting station, and the navigator can thus work out his own position.

Excellent results are obtained by both of these methods. As the use of wireless navigation increases the tendency must be for the ships to possess their own direction finding sets, as the other method involves such a large amount of wireless transmission for the special purpose of direction finding, and it is impossible in a congested area to deal with a large number of ships at the same time. In cases where the direction finding apparatus is installed on the ship, all ships can determine their own position at the same time, being independent of any shore organisation.

At sea in cases of fog there are many instances on record of ships actually navigating with confidence and with certainty right into harbour; whereas without wireless navigation they would probably have had to await suitable weather conditions before entering harbour. The importance of this in the saving of time is obvious.

At sea wireless navigation is thus of the utmost importance over comparatively short distances, and under these conditions it is very satisfactory and errors are seldom obtained.

In the concluding article a discussion will be given on the principles which underlie direction finding, and possible explanations of why the night variations occur.

Are you reading "Wireless Weekly"?

"Wireless Weekly," the latest Radio Press publication, is the premier weekly journal, just as "Modern Wireless" is the premier monthly, and is regarded as an indispensable

source of reliable information by all interested in wireless. It contains the latest and most up-to-date articles, and is always attractive and interesting.



Above & below the Broadcast Wavelengths

By LAMBDA.

Directional Transmissions.

THOUGH numerous references to very short wave directional transmissions have appeared from time to time in the daily papers, the matter has not been dealt with, so far as the writer is aware, at any length by the technical press. At the present time the Marconi Company are the only people who are devoting much attention to the problem in this country, and though their results have been amazingly successful, they have not chosen to make them public in any kind of detailed form. Directional reception is another matter altogether. Here a vast amount of experimental work is always going on, conducted by both amateurs and professionals. It aims at cutting out to the greatest possible extent all outside interference, and so bringing only the desired set of signals into the telephones of the receiving set. Directional transmissions have quite a different object. Their ultimate aim is to make wireless transmissions approach the selectiveness of those of the land telephone. All transmissions sent out from an aerial of the ordinary type must be broadcast; that is, they can be received up to any reasonable range by anyone operating a sufficiently sensitive set in no matter what direction his station may lie. Secrecy of any kind thus becomes a matter of impossibility unless messages are sent in code, and it is doubtful whether any code exists which cannot eventually be deciphered if sufficient trouble is taken.

Some Problems.

In his early experiments Senatore Marconi employed what were really the original Hertz reflectors, and investigation along these lines might have gone forward had it not been for the invention and development of the high-earthed aerial, which first established wireless on a sound commercial basis. This necessitated the use of waves of a much longer kind, and as it was so successful experiments with the reflector method of transmission came almost to a full stop. With the rapidly increasing use of wireless, however, many difficult problems arose. The chief of these was the interference with other stations caused by the sending of flat-tuned spark signals, which can sometimes be heard for a hundred metres or more on either side of their proper wavelength. The C.W. method of transmission introduced infinitely sharper tuning, but the arc system, which is largely used by Government stations, is given to producing harmonics. This method is also responsible for the "mush" that is sometimes so bad on the shorter wavelengths as to make reception of weak or distant signals a matter of impossibility.

Telephony.

The coming of wireless telephony brought a whole host of fresh problems in its train. Telephonic transmissions cannot be quite sharply tuned, hence they are very apt to cause mutual interference. Those who live near a broadcasting station will have found how extremely liable its transmissions are

to drown others even on a wavelength differing by 30 metres or more. The tendency has been for C.W. transmissions to climb higher and higher in the scale of wavelengths, whilst telephony has rather specialised on the lower ranges. On these it has achieved remarkable results. The London station, 2 L.O., for instance, is regularly heard in the Shetlands on one valve, and its listeners-in live in all parts of Western Europe from Norway to Spain. The reception of America broadcasting on a 360 metres wavelength is now so usual in this country that one has almost ceased to regard it as a particularly striking feat when conditions are favourable.

Reflectors.

If wireless telegraphy and telephony continue to develop at their present rate it is only a matter of time until the huge number of stations in use makes mutual interference so troublesome that good reception is the exception rather than the rule—provided, that is, that each transmitting centre is allowed to radiate its messages in every direction. There is a further disadvantage in non-directional wireless: as the waves are flung out equally in all directions like ripples that course over the surface of a pond when a stone is thrown into the water, an overwhelming proportion of their energy is wasted, and only the tiniest fraction of it ever reaches those for whom it is intended. This means that the power used for transmission is hugely in excess of what would be required if

only some means of focusing a wireless beam could be used. Light rays and heat rays can be focused into a pencil by the aid of parabolic mirrors. As both of these are ether waves, there seems no reason why the same process should not be applied also to wireless. The difficulty lies in the enormous length of wireless waves as compared with those of light and heat. We know that the last are reflected by metallic surfaces, but to deal effectively with, say, those of a 1,000 metres station we should need reflectors several miles in length. This fact alone is sufficient to make any attempt at focusing such waves out of the question.

Very Short Waves.

If any solution on these lines was to be found it could lie only in the use of waves so short that reflectors of reasonable size could be used to focus them. Since 1916 the Marconi Company has been conducting experiments with waves ranging from a maximum of 15 to a minimum of 3 metres. The company has two stations for this work, one at Hendon, and the other near Birmingham, the distance between them being almost exactly 100 miles. Some account of the result obtained was first given by Mr. Franklin at a meeting of the Institution of Electrical Engineers a year ago.

The Method.

The special focusing appliance consists of a parabolic reflector, at the focus of which is placed the aerial, whose length is approximately half that of the wave in use. The actual transmitting circuit has not been made public, but the aerial output is stated to be 300 watts, and the ratio of the efficiency, measured between valve input and aerial power, is in the neighbourhood of 60 per cent. The strength of the speech between the two stations is such that to equal it a kilowatt transmitter working on an aerial of standard type would have to be used, the efficiency of this set reaching the same figure as that used for the very short waves. As regards the directional qualities of the transmissions reception is quite impossible by persons who are

situated more than a quarter of a mile on either side of a line joining the two stations. Thus a very great deal has been accomplished.

Reception.

Reception presents rather a problem, for the ordinary direct methods cannot be used. Everyone who works on the long and the short waves in ordinary use must have realised how much more marked are capacity effects with the latter. The higher the frequency of oscillating currents the more readily do they pass by capacity; hence when we come down to 15 metres, which means a frequency of 20,000,000 cycles a second, the tiniest capacities, such as must always exist even in the most carefully arranged and most skilfully wired receiving set, will have far-reaching effects. The only

of roughly 500,000 cycles, the difference in frequency between the two circuits. This beat is equivalent to a wavelength of 600 metres. If therefore we tune the primary of the receiver to 600 metres we can use it with almost as little trouble as if we were listening to shipping transmissions. Thus a standard high frequency, rectifying and low frequency set may be used. For the oscillator it is essential to use valves of the test-tube type, such as V24, QX, D.E.V., D.E.Q., or the Mullard Ora B, S3 and S5. The internal capacity of other types is too high for them to be of any use at these tremendous frequencies. The principle of the circuit given can be applied to reception on 15 metres or less.

Application to Shipping.

The directional system has already been applied to shipping requirements with great success. If one tunes to 450 metres, on which wavelength this work is done, some ship asking a land station for her bearings is often to be heard. As soon as she is in touch with the directional station, she sends a long series of vics to enable those ashore to get her position. This is worked out and transmitted very rapidly. At Inchkeith, in the Firth of Forth, is a "wireless lighthouse," a focused-beam transmitter, which revolves once every two minutes, sending out a different letter for each half-point of the compass. In this case a spark transmitter is used, the wavelength being four metres. The receiving aerial, placed on the bridge of the ship, is a length of wire measuring only two metres. Yet with a single-valve receiver good signals can be obtained up to a distance of ten nautical miles. Some experiments with a radio compass of the same type seem to have been made recently by one of the air stations. The writer picked up several times on 900 metres the unmistakable sound, faint at first, growing rapidly to maximum intensity, then dying away, of a revolving focused beam; but as no messages accompanied the transmissions he had no idea of the location of the apparatus.

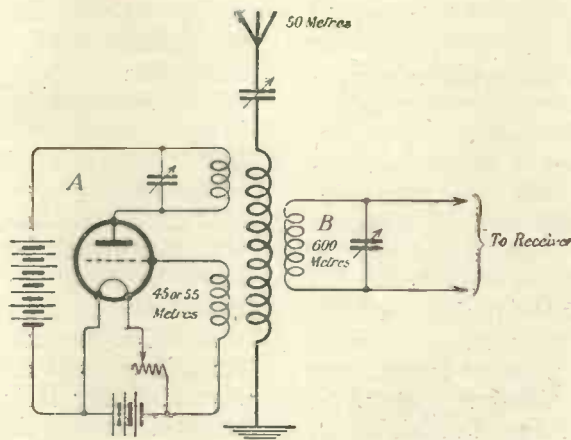
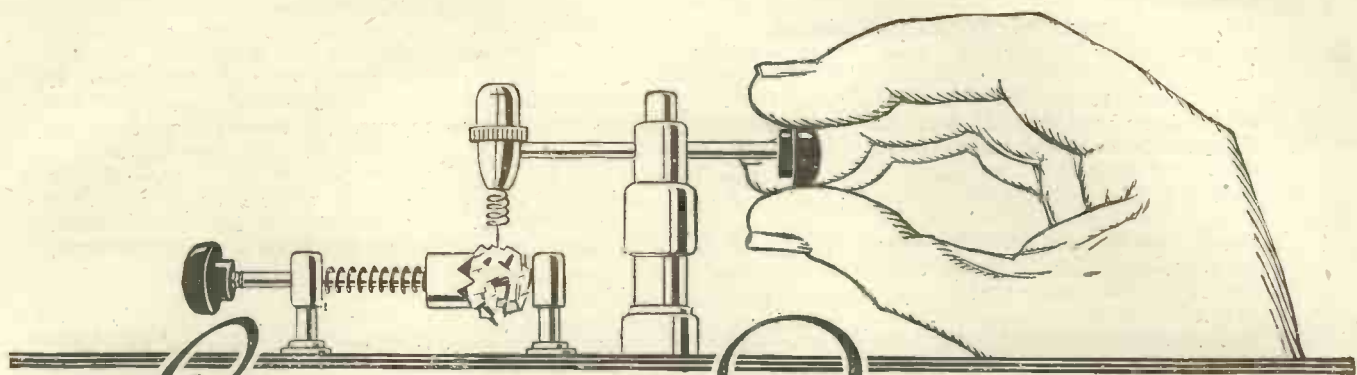

Fig. 1. The circuit used for the reception of 50-metre transmission.

method that is at all satisfactory is that known as the supersonic heterodyne, which is simply an extension of the heterodyne system, applied in this case, not to C.W., but to telephony. Fig. 1 will serve to explain the way in which it works. Let us suppose that a transmission on 50 metres is being received. Either a very short open aerial or, better still, a frame is tuned to this wavelength in the ordinary way. A local heterodyne (A) is then adjusted to oscillate at either 45 or 55 metres. Now the incoming oscillations have a frequency of 6,000,000 cycles a second. The local heterodyne oscillates at either 6,666,666, or 5,454,545 according to our tuning, but in either case the arrangement gives a beat note.



Crystal Points

An Adjustment Tip

WITH fairly strong signals it is usually somewhat difficult to decide when one has got the best possible adjustment on the crystal, since the ear is much less discriminating where loud sounds are concerned than in the case of weak ones.

The difficulty can be easily overcome by adopting the following method of adjustment: First, tune in the desired station and set the detector to give what appears to be maximum signal strength, then alter the tuning until the signals become very nearly inaudible and carefully readjust the pressure upon the crystal, and perhaps try different spots upon it, until you strike an adjustment which brings the signals in a little more loudly again. Then detune the set still further, and repeat the procedure already outlined until confident that the best possible adjustment has been obtained, whereupon the tuning may be restored to the correct value and the signals will come in with an increase of volume which is often surprising.

An incidental advantage of this method is that it enables one to estimate the relative merits of various crystals, by noting how far the detuning process can be carried before the signals become inaudible with even the best adjustment. The number of degrees through which a condenser or variometer can be turned, or the distance which the slider contact can be moved, can be used as a measure of the sensitiveness of the crystal.

Mounting Crystals

The adoption of a good method of mounting of crystals is quite an important factor in their

successful use, and much of the dissatisfaction which one often hears expressed regarding the performance of crystal sets originates from bad mounting.

The ideal method is probably the use of Wood's metal, provided that due care is taken not to overheat the crystal in the process. There seems, however, to be a general prejudice against this method, perhaps because it makes the substitution of a fresh crystal a slightly more troublesome operation, and screw-cup detectors are used to an extent far in excess of that which their merits really warrant. Their chief drawbacks are these: first, to grip the crystal firmly it is necessary to apply considerable force to the screws, which often causes a fragile specimen to crumble, and, secondly, the crystal may only make contact at two or three quite small points with the cup, and these points may set up rectifying effects which oppose that produced at the cat-whisker contact.

The only really satisfactory way of mounting a crystal in a screw-type cup is to pack it in with tin-foil, tighten the screws, and then pack it all round with more foil until ample contact is assured.

Don't Finger Crystals

A very common mistake made by users of mineral detectors is to subject them to a good deal of handling in the process of mounting in their cups. The practice is one to be deprecated most strongly, for the sensitiveness of a crystal depends in large measure upon the condition of its surface; a mediocre crystal with a perfectly clean fresh surface will often

give better results than a far more sensitive specimen which has become dirty and greasy with excessive handling.

It must be remembered that the human skin is always slightly moist and greasy, and hence apparently "clean" fingers are capable of dirtying crystals to a serious extent. Moreover, when the operation of mounting the crystal in its cup is performed in the workshop one's fingers may be far from clean, and a perfectly good crystal may be completely spoiled before ever rectifying a signal.

It is sometimes recommended that crystals should be picked out of their packing with forceps and at once placed in the detector cup without being touched by hand, but this is probably a counsel of perfection which most people will consider too troublesome to follow. As a practical compromise, turn the crystal over in its box or packing and decide which of its faces looks the most promising, then pick it up in such a way that the fingers do not come in contact with the surface which it is proposed to use, and place the crystal in its cup. With reasonable care this method is quite satisfactory.

Rejuvenating Crystals

Users of crystal sets will be familiar with the fact that the majority of crystals, more particularly some of the super-sensitive synthetic varieties, are prone to lose their "good spots" with exposure to air and dust, and become useless in time.

Various methods of restoring the sensitiveness of "worn out" crystals have been tried and some of them are fairly successful. The most obvious remedy, of course, is to break off a piece of the crystal and so expose a fresh surface for use, but the objection to this sort of treatment is that some of the specially-faked crystals are only sensitive upon the surface.

Washing the surface with absolute alcohol or carbon bisulphide sometimes works wonders with crystals which have lost their freshness, but care must be taken to dry the crystal thoroughly before re-testing it. (Do not dry it before the fire, by the way, because both the re-agents mentioned are extremely inflammable.)

A method which has a considerable vogue in the United States is to subject the crystal to prolonged heating by immersing it in molten Wood's metal, but it is doubtful whether this treatment would suit the surface-sensitive varieties.

Damping in Crystal Sets

By "damping" is meant the effect produced upon the received oscillations by all the losses which occur in the set. In the case of a crystal set the avoidable losses are chiefly matters of leakage and resistance, and care taken in reducing them as much as possible is well repaid by improved signal strength and an increased sharpness of tuning.

Prevention of leakage, of course, is a matter of attending carefully to insulation, both upon the aerial and in the set, by shellacking and baking tuning coils and formers, avoiding damp, and using ebonite wherever possible, or failing ebonite, wood which has been damp-proofed either by varnishing and baking, or, better, by soaking in hot melted paraffin wax until bubbles cease to rise.

Reduction of resistance, it should be remembered, is only of importance in the tuned (*i.e.*, aerial to earth) circuit, and is to be effected by using heavy wire for the aerial, lead-in, and earth lead, making sure of a really good earth connection (see the article on "The importance of a good earth" in the June number of "M.W.") and winding the tuning coils with a stout gauge of wire, say, No. 20 S.W.G.

The Use of a Testing Buzzer

When a crystal set is used at a considerable distance from a broadcasting station it is necessary to adjust the crystal to a sensitive condition before starting to tune in, and a convenient method of doing so is to make use of a testing buzzer. This valuable little accessory constitutes a simple transmitter of very weak wireless waves whose tuning is so flat that they may be heard upon any adjustment of the tuning, thus permitting the detector to be easily tested.

The buzzer, which should be of the high-note type for preference, is fitted up with a switch and dry cell, and a length of about three feet of insulated wire is attached to the contact-point to act as a miniature aerial.

The testing set should be placed at a distance of a few feet from the receiving set, and it will then be found that when the crystal is properly adjusted the note of the buzzer will be heard in the 'phones when the switch is closed. The indications are more easily noted if the buzzer is silenced by enclosing it in a box lined with felt or cotton wool.

THE MEASUREMENT OF WIRELESS QUANTITIES

By E. H. CHAPMAN, M.A., D.Sc., F.R.Met.Soc. (Staff Editor).

This article should go far to remove the very prevalent belief that all calculations of a wireless nature are necessarily formidable. The methods given should be of great value to those who wish to design their own apparatus.

I.—Capacity of Variable Air Condensers.

THE mathematical formulæ for the calculation of wireless quantities generally look so complicated to the wireless experimenter that he is discouraged at the outset in his attempts to apply them to any particular piece of apparatus he happens to be assembling. Even when he does actually use the formulæ, the experimenter wastes a good deal of time which he could put to much more profitable use. Hence, not only from the point of view of simplicity of calculation but also from the point of view of time saved, it is desirable

to have close at hand a means for the easy and rapid calculation of the quantities involved in wireless work.

To avoid the use of complicated formulæ and to enable the experimenter to make his calculations with speed and accuracy, the diagrams which accompany this series of articles have been carefully prepared. Underlying each diagram is a mathematical principle which will be at once recognised by the mathematician. Some of these principles have been applied before to wireless work. Others, however, are used here for the first time in connection with the work of the wireless experimenter. Whether the method be old or new, the manner of presentation has been simplified as much as possible.

The present article deals with the calculations connected with variable air-condensers of which the rotating vanes are semi-circular.

Let us first suppose that we wish to con-

struct a variable air condenser with a maximum capacity of .002 microfarads and that we have all the necessary component parts. Our problem is to determine the number of vanes to be mounted on the spindle.

We require to know two things :

- (1) the radius of a rotating vane,
- and (2) the thickness of the air-space between the fixed plates and the rotating vanes.

The first of these measurements is quickly made by placing a rotating vane in position over Fig. 2. The straight edge of the vane

must lie along the base line of the measurement chart and the centre of the spindle hole (square or round as the case may be) must be placed as

nearly as possible over the centre point of the chart. The radius required is read off from the scale provided. It should be noted that the scale readings increase outwards from the centre of the chart. An example is shown in Fig. 2, of a vane in position, the radius being 3.1 centimetres.

We have next to find the thickness of the air-space between plates and vane as shown in Fig. 3. To do this we mount a number of vanes on the spindle in the usual way and screw up firmly in position. Next we choose two convenient consecutive numbers, say six and seven. We then measure the total thickness of seven washers and six vanes. This can be done quite easily on the side of the spindle away from the vanes. In measuring a thickness such as this when there is one more washer

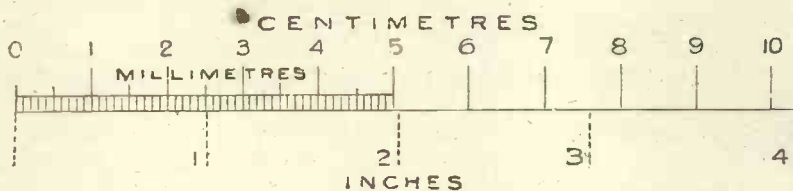

Fig. 1.—In wireless, as in all scientific work, measurements are made on the metric system. This centimetre-inch conversion scale will be found useful for reference. 1 inch = 2.54 centimetres.

than vane note that the measurement is made from the *inside* of one vane to the *inside* of another vane. We now measure the total thickness of *six* washers and *seven* vanes. When the thickness measured includes *one*

Having now (1) a radius of rotating vane of 3.1 cms and (2) a thickness of air-space of 2 mms. we turn our attention to the measurement chart in Fig. 5. First we place our ruler

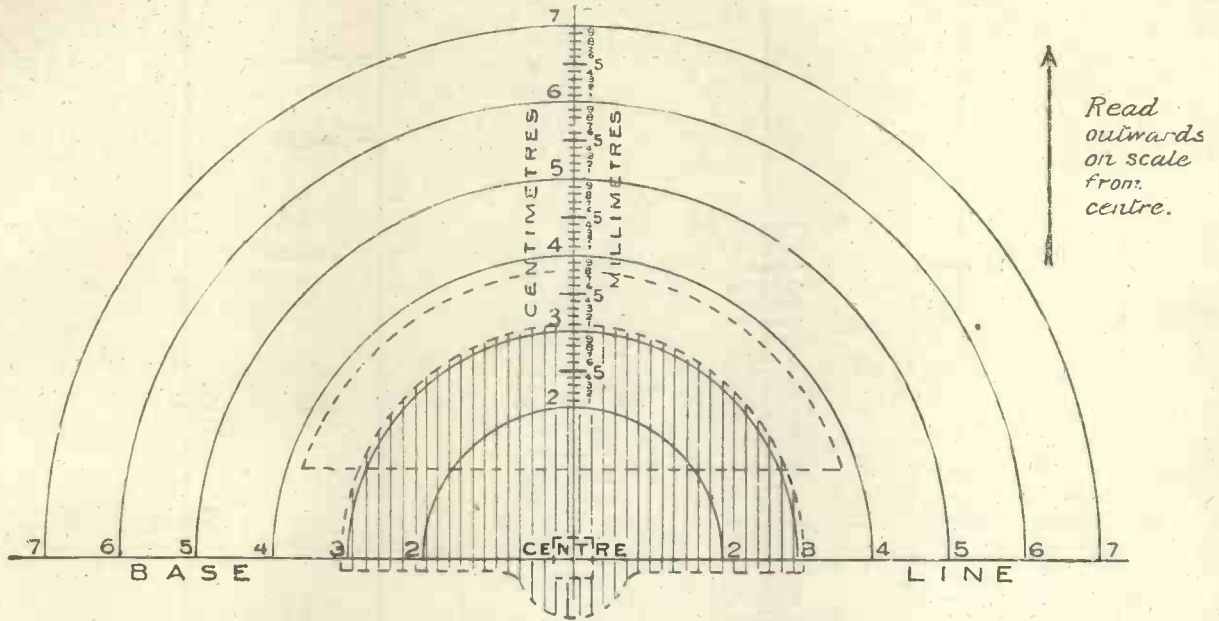

Fig. 2.—Place the vane with its straight edge along the base line of the chart, and place the centre of the vane (centre of spindle hole) as nearly as possible over the centre of the chart. Read off the radius from the scale provided. On the chart a vane with radius 3.1 centimetres is shown in position.

more vane than washer note that the measurement is made from the *outside* of one vane to the *outside* of another vane. Subtracting the two measurements thus made we get the required thickness of air-space. Any two consecutive numbers will do instead of six and seven. If for a certain pair of numbers

across the chart in the position *AB* in which the edge of the ruler near *A* passes through the

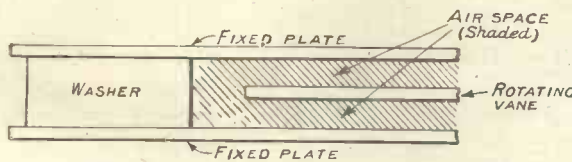

Fig. 3.—Enlarged diagram showing air-space between plates and vane.

the measurements are awkward to make, try another consecutive pair. In all cases it is a good thing to carry out the measurements with a second pair of consecutive numbers in order to check the measurements made with the first pair. The example illustrated in Fig. 4 (which is drawn to scale) gives an air-space thickness of 2 millimetres.

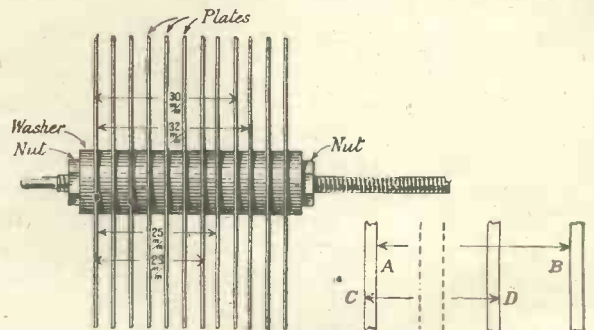

Fig. 4.—Showing how to find the thickness of the space occupied by air between two fixed plates, allowance being made for the rotating vane between them. Mount a number of vanes on the spindle and screw up tightly. Choose two convenient consecutive numbers—say six and seven. Measure the thickness of seven washers and six vanes. This is *AB* in the figure, and is 25 millimetres. Then measure the thickness of six washers and seven vanes. This is *CD* in the figure, and is 23 millimetres. Subtract 25—23, and the result—2 millimetres—is the required thickness of air space. Any two consecutive numbers will do. When measuring more washers than vanes, measure from inside of vanes. When measuring more vanes than washers, measure from outside of vanes.

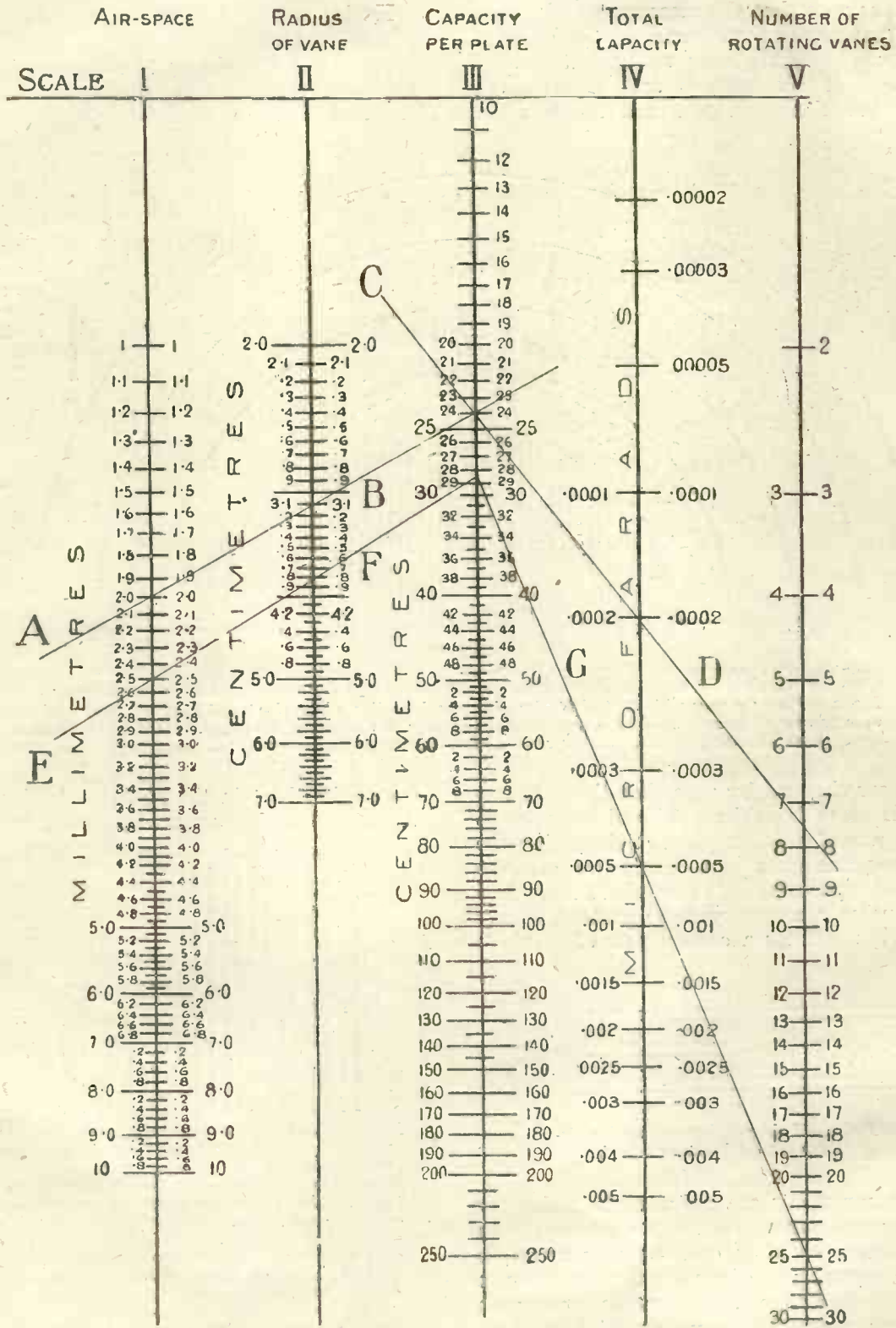

Fig. 5. With this chart, measurements can be made very accurately and rapidly. Each scale is constructed to read downwards, and readings are given on both sides of the scale where necessary. In this way a ruler placed across the scale does not obscure the readings required.

reading 2 mms. on Scale I. (air-space) and in which the edge of the ruler near *B* passes through the reading 3.1 cms. on Scale II. (radius of vane). We note that the edge of the ruler gives a reading of 24 cms. on Scale III. (capacity per plate). We now move the ruler and place it in the second position *CD* in which the edge passes through the readings 24 on

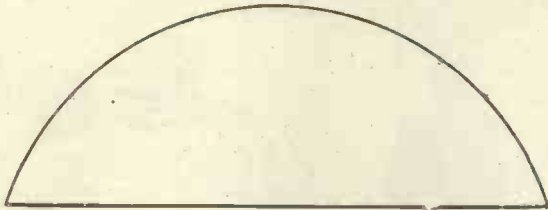

Fig. 6.—Paper copy of part of a rotating vane, radius of which is 3.8 centimetres.

Scale III. and .0002 on Scale IV. the total capacity required being .0002 microfarads. In the position *CD* the ruler indicates a reading between 7 and 8 on Scale V. (number of rotating plates). To be on the safe side we select the higher number 8 and mount 8 vanes on our spindle.

It should be noted here that in all our calculations it is assumed that the condenser has one more fixed plate than moving vanes in other words, that each moving vane moves in between two fixed plates.

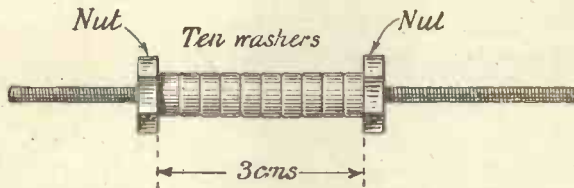

Fig. 7.—Alternative method of measuring thickness of air space. (i.) Place ten spacing washers on a piece of brass rod. Screw a nut on the rod at either side of the washers. The nuts should be screwed up tightly. Measure the distance between the inner faces of the two nuts—3 cms. in above diagram. Thickness of one washer = $\frac{3}{10}$ cms., or 3 mms. (ii.) Repeat with 10 rotating vanes. Thickness of 10 vanes = 5 mms. Thickness of 1 vane = .5 mms. (iii.) Air space required = Thickness of washer less thickness of vane (see Fig. 3) = $3 - .5$ mms. = 2.5 mms.

Next let us suppose that we are given a built-up condenser and we are asked to find its maximum capacity without dismantling it. With the condenser "out" we make a paper copy of as much of one of the moving vanes as we can get at. It is not necessary to copy the whole vane. Our copy will be something like that in Fig. 6. We place this copy in position on Fig. 2, so that the circular edge

of our copy runs parallel to the circles in the figure. It is of the utmost importance that the circular edge should be parallel to the circles drawn in Fig. 2. Another way of looking at it would be to say that the circular edge of the copy must everywhere be the same distance from the next bigger circle of Fig. 2. The copy in Fig. 6 is shown in position on Fig. 2 by a broken line outline. The radius 3.8 cms. is indicated on the scale provided.

By the method indicated in Fig. 4 we can find the thickness of the air-space in the given condenser. Suppose then, that we have obtained the following three quantities :

- (1) radius of vane 3.8 cms,
- (2) thickness of a r-space 2.5 mms,
- (3) number of vanes 25.

By placing a ruler across the chart in Fig. 5 in the position *EF* (2.5 on Scale I., 3.8 on Scale

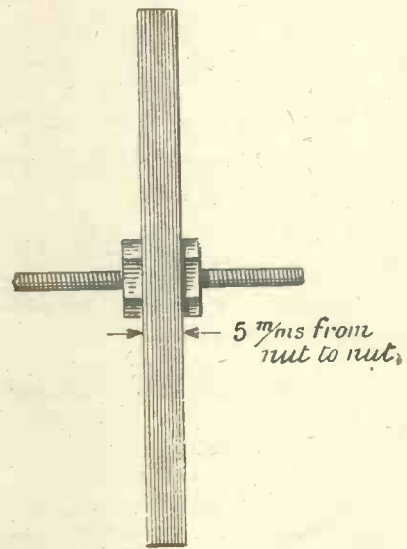

II.), we get a reading of 28.5 on Scale III. Then, by placing the ruler in the position *GH* (28.5 on Scale III. and 25 on Scale V.) we read off on Scale IV. the required capacity .0005 microfarads.

An alternative and perhaps more accurate method of determining the thickness of the air-space in a variable condenser is indicated in Fig. 7.

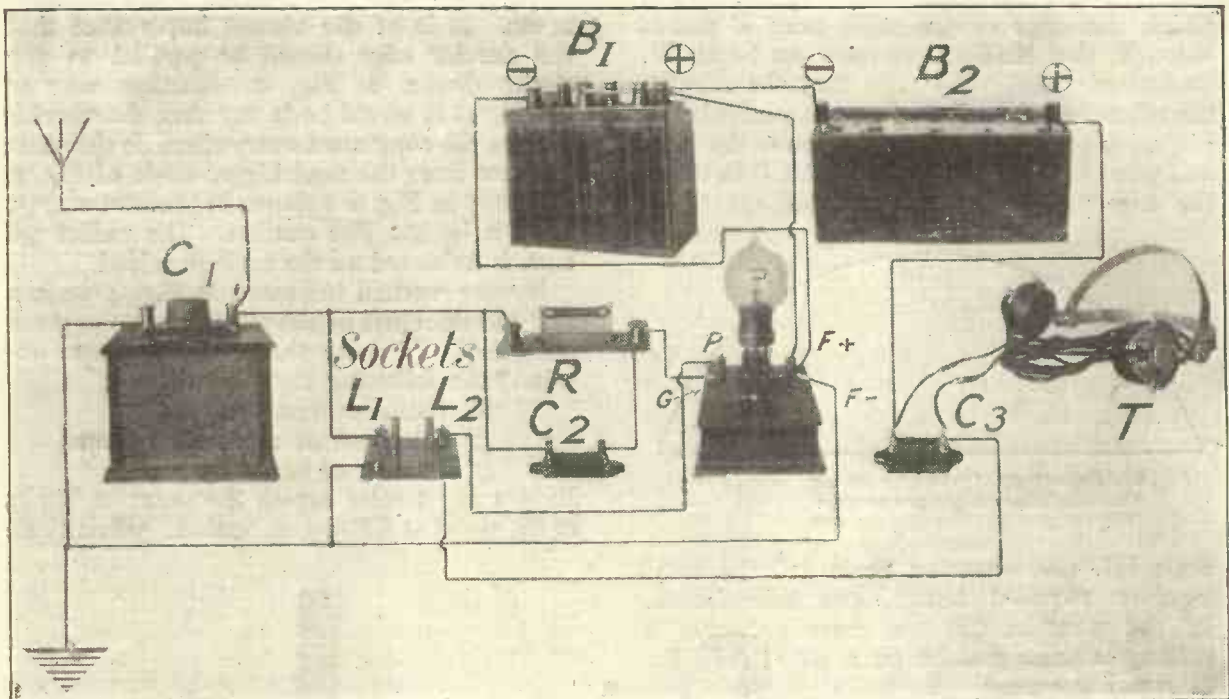

Fig. 1.—Showing the connections of the set, and a suitable arrangement of the parts.

A SIMPLE LONG WAVE SET

By PAUL WOODWARD.

Instructions are given in this article for the assembly of a very simple all-wave receiver from component parts.

WHEN the wireless novice realises that his hobby holds much enjoyment for him over and above the reception of broadcasting, he begins to look about for a design for a long wave set to enable him to hear time signals, aircraft telephony, high-power morse stations, and so on. Now, most of the universal wave-length receivers which he sees described are not very suitable for his purpose, for the reason that they are of so advanced a type as to be beyond his only moderate operating skill.

The set described in this contribution could almost be called the simplest possible long wave receiver, both in construction and operation, and yet it is capable of giving surprisingly good results when used upon a reasonably

efficient aerial. The results, of course, are obtainable simply because full advantage can be taken of reaction into the aerial circuit, whose virtues we are apt to overlook in our abhorrence of its vices when used by ignorant (or selfish) persons upon the broadcast wave-lengths. A set of this sort, it cannot be too emphatically stated, is absolutely taboo for the reception of British broadcasting, and must on no account be used for waves of less than 600 metres.

Using a circuit of this type with home-wound lattice-coils upon an aerial of somewhat more than average efficiency, the writer could regularly receive the American stations at Tuckerton and Marion, while the time signals from Annapolis were audible, though the signals of this station were not

often readable. The principal European stations were all easily received, including such distant ones as Moscow, Budapest, Sofia, and Constantinople. Such long distance reception with a single valve is, of course, only possible with very careful adjustment of the reaction and tuning, but the set is so simple that the necessary skill is readily acquired, and there is no reason why these results should not be equalled by anyone possessing a fairly good aerial, especially if a soft valve can be obtained.

The circuit of the receiver is shown in Fig. 2, and is simply the standard single-valve reaction type, with the valve rectifying by virtue of a grid condenser and leak. The values of the various components are indicated in the diagram, and

should be fairly closely adhered to if the best results are to be obtained.

Materials and Components Required

- 1 valve.
- 1 valve panel.
- 1 fixed condenser, .002 μF capacity.
- 1 fixed condenser, .0003 μF capacity.
- 1 variable condenser, .0005 μF capacity.
- 1 grid leak of 2 megohms.
- 1 pair of grid leak clips.
- 1 piece of ebonite 3 in. by 1 1/2 in. by 1/4 in.
- 1 piece of ebonite 4 in. by 3 in. by 1/4 in.
- 1 6-volt 41 ampere hour accumulator.
- 1 60-volt H.F. battery.
- 6 terminals.
- 4 valve legs.
- Set of coils.

In purchasing the valve panel make quite certain that what you are obtaining is simply a panel carrying terminals, valve-holder, and filament resistance, and not a complete detector unit. The latter would, no doubt, serve the present purpose, but would not be so useful to the experimenter when he later wishes to use it in other

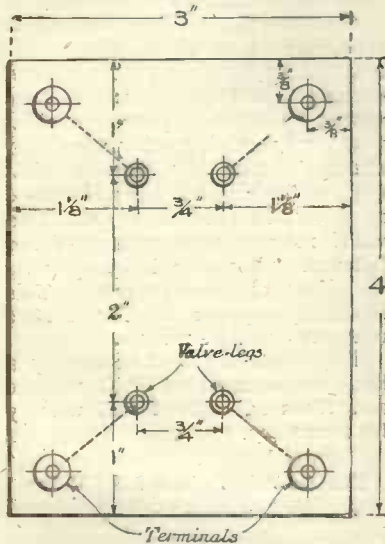

Fig. 3.—Plan of the ebonite base for the coil sockets.

sets, and is therefore not to be recommended.

It is very important that the grid leak should be constant and accurate in value, and hence one of a reliable make should be purchased. It is to be mounted

between the clips upon the strip of ebonite whose dimensions are 3 by 1 1/2 inches, a pair of terminals being also mounted upon this strip and connected with two short pieces of wire to the clips. A grid leak mounted in this way was illustrated on p. 349 of the June

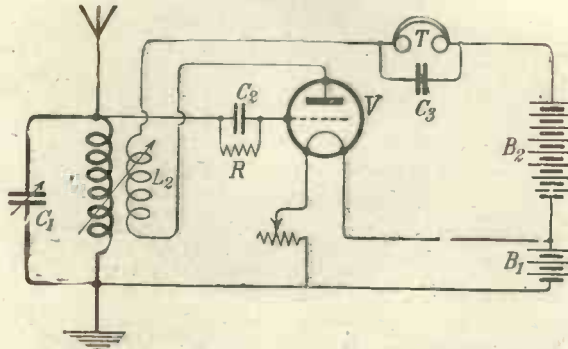

Fig. 2.—The circuit of the receiver.

number of MODERN WIRELESS. This method of mounting the leak is to be preferred to inserting it in the clips of the grid condenser, since it enables one to connect the leak direct from grid to filament positive or negative as required.

Tuning and Reaction Arrangements

The set contains only one tuned circuit (hence the simplicity of its operation), namely, that provided by the coil L and the condenser C, these being in the aerial-earth circuit, of course. The variable condenser has a maximum value of .0005 μF , and is connected in parallel with the coil, since the set is to be used upon the longer waves.

In the plate circuit of the valve is connected a second coil, L₂, which is coupled to the first coil to produce the desired reaction effects. These coils may be either slab coils, purchased or home-made according to the directions given on p. 182 of the April number of MODERN WIRELESS, or lattice coils, also wound in accordance with instructions given in the second article upon "Multi-layer coils" in MODERN WIRELESS for May, p. 250. Whichever type of coil is decided upon, a complete set should be wound or bought, in order that all the longer waves may be covered.

The coils employed in this receiver need not be mounted in any way, since they are used lying flat upon the table, the necessary adjustment of coupling being obtained by sliding one over the other. To enable the coils in use

to be replaced easily a very simple plug-in arrangement is used consisting of valve legs for the socket part, and valve pins attached by short pieces of flex to the ends of the coils.

The socket or holder to which the coils connect when in circuit consists of a piece of 4 by 3 inch ebonite upon which are mounted four terminals and four valve legs, in the positions indicated in Fig. 3. The pairs of valve legs at each end are connected to the respective pairs of terminals by short pieces of wire underneath the ebonite, as shown by the dotted lines in the figure.

The complete socket panel can be screwed down upon the baseboard upon which the set is assembled, or upon a separate block

of wood 4 inches long, 3 inches wide, and 1 inch thick. In either case the wood should be recessed beneath the ebonite panel to accommodate the projecting parts of the terminals and valve legs, and also the short connecting wires. This may be easily done with a brace and bit and a pen-knife.

The coils may next be prepared for use by soldering to their ends pieces of single flex six inches long and binding the coils up in the usual way with Empire tape. The ends of the six-inch lengths of flex are then to be furnished with



Fig. 4.—One of the terminal pins of the coils.

valve pins, so that the coils can be plugged into the sockets.

A simple method of doing this is illustrated in Fig. 4. The first requirement is some systoflex of a diameter of about 3/16 of an inch: this is cut into one-inch lengths and a piece slipped upon each flexible lead. The requisite number of valve pins are then relieved of their nuts and washers, and the end of each wire is soldered to the end of the threaded portion of a pin. This done, the 1-inch lengths of systoflex are slipped down and driven over the threaded

part of each pin up to the shoulder. If a suitable size of systoflex has been chosen (take a valve pin with you when you go to buy it) it will be a tight driving fit, and the result will be a neat black plug of the appearance shown in Fig. 4.

A finished slab coil is shown in Fig. 5.

Assembling and Wiring.

The components should preferably be laid out upon a board about 2 feet long by a foot wide, and screwed down in the positions indicated in Fig. 1. The wiring of the set is a simple matter, and should be made quite plain by Fig. 1. The connections are best made with stiff wire sleeved with systoflex and kept clear of the wooden base, whose insulating properties may not be of the best.

Operation of the Set

The operation of this little set is simplicity itself; one has merely to see that all the connections have been correctly made, switch on the valve so that it burns fairly brightly and proceed to tune-in by inserting coils in the sockets and turning the variable condenser. If the desired station is not heard, try a larger or smaller coil as L_1 , and rotate the variable condenser once more.

and touch the aerial terminal of C_1 with a moist finger; little or no sound will be heard in the 'phones when this is done. Now bring the coils together, gradually pushing one over the other, meanwhile repeatedly touching the aerial

large as to make it oscillate irregularly and uncontrollably, its size is quite immaterial.

The set is in its most sensitive condition for the reception of C.W. signals when the reaction is only sufficiently strong to just keep it oscillating, and tightening the coupling beyond this point will weaken the signals. Spark signals may be heard "true note" with the set in the non-oscillating condition, becoming louder as the reaction is increased, and turning finally into a still louder "scratch-note" when the set oscillates. It is questionable which is the easier to read, the true note signals of moderate strength obtained when the reaction is increased almost to the point of oscillation, or the louder hoarse sounds heard when the set oscillates.

Telephony is heard in a somewhat similar manner to that noted in the case of spark signals, in that it is heard clearly so long as the set does not oscillate, but more loudly and violently distorted when it does. In the latter case it is also accompanied by howls resulting from the carrier-wave being heard at the same time. Therefore, when receiving speech increase the reaction as far as possible without causing self-oscillation. Care should be taken to prevent oscillation in receiving telephony for another reason also, namely, that even on the long wave-lengths there is a certain amount of radiation which may interfere with any other listeners who may be very near to the oscillating set. This especially applies to The Hague concerts on 1,080 metres.

To obtain the best of results a little adjustment of H.T. voltage and filament current will usually be necessary.

The Addition of an L.F. Valve

For ease in receiving the more distant stations it may be desired to add a second valve as a low-frequency amplifier to bring their signals up to a readable strength. The circuit would then be as indicated in Fig. 6, which shows how a double-pole change-over switch may be used to bring the second valve in or out of circuit as required.

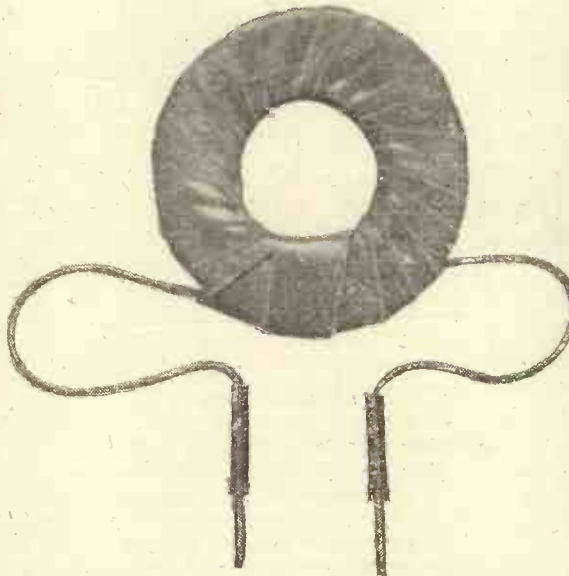

Fig. 5.—A slab coil taped and provided with plugs.

terminal with the finger; a point will be reached presently at which clicks are heard each time the terminal is touched, and the set is then oscillating and capable of receiving continuous waves.

Should oscillation not result even

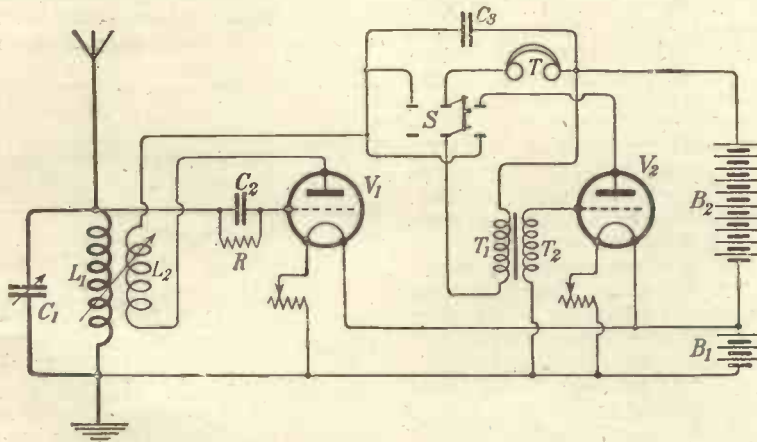

Fig. 6.—Showing how to add a low-frequency valve.

The reaction must also, of course, be adjusted correctly when tuning-in. If the search is for continuous wave signals the set must be kept oscillating, and to do this one must be able to test for oscillation. Start with the coils L_1 and L_2 widely separated upon the table

when the coils are closely superposed, turn one of them over, and if the set still does not oscillate use a larger coil as L_2 . The size of the reaction coil is not of any great importance, by the way; so long as it is large enough to make the set oscillate readily and not so

AN EASILY-MADE WAVE-METER FOR 300 TO 9,000 METRES

By H. C. EXELL, B.Sc.

Some sort of wave-meter, even if only roughly made and calibrated, is a necessity to the experimenter who aspires to serious work, and a convenience to all listeners-in. Sufficient practical details are given in this article for the construction of a serviceable instrument.

THE following is a description of a wave-meter which has given excellent results, and has amply repaid the little trouble in its construction. It has been found extremely useful for tuning a receiver to a given wave-length, and also for determining the points at which tapplings should be taken on a coil in order that it may respond to some particular wave-length when connected to the aerial, for calibrating closed circuits, measurement of wave-length of stations received, and many similar uses.

Circuit and Finished Instrument

The wave-meter is contained in a wooden box 8 in. by 6½ in. by 5 in., and it will be seen, therefore, that the finished instrument is quite compact. A general idea of the wave-meter can be inferred from Fig. 1. The circuit is shown in Fig. 2, the various components of which are to be described in detail.

The Variometer

The variometer former is shown in Fig. 3. The winding formers are made from flat pieces of wood, the outer being 2½ by 4 by 4½ in., and the inner 1½ by 3½ by 3 in. The outer former is wound with 70 turns of No. 26 enamelled copper wire and the inner former is wound with 90 turns of No. 30 enamelled copper wire. A clear space is left in the middle of each former in order that the spindle may pass through; half the winding, of course, being fixed on each side as shown in Fig. 3. The spindle is made of wood, a length of 4½ in. from a curtain rod about .4 in. in diameter being suitable.

The method of fixing the vario-

meter in the box can be seen from Fig. 4. Two holes are made in the side of the outer former of such a diameter that the spindle can just pass through them with little friction, while the holes in the smaller former are so made that the spindle fits into them friction tight. Rotating the spindle, therefore, causes the smaller former to be carried round with it. A little glue may be used to make it quite secure.

A suitable knob at the end of

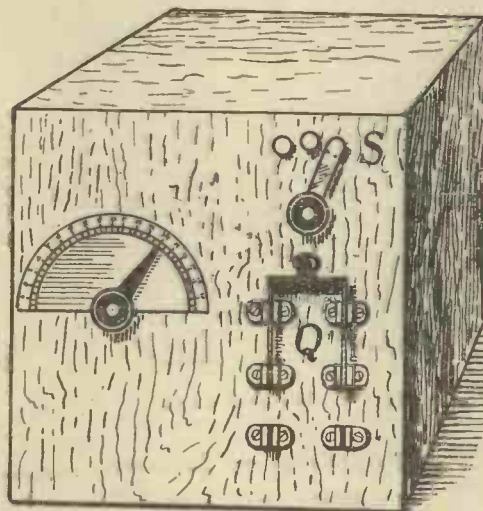

Fig. 1. The completed instrument.

meter in the box can be seen from Fig. 4. Two holes are made in the side of the outer former of such a diameter that the spindle can just pass through them with little friction, while the holes in the smaller former are so made that the spindle fits into them friction tight. Rotating the spindle, therefore, causes the smaller former to be carried round with it. A little glue may be used to make it quite secure. A suitable knob at the end of the spindle is made from half a cotton reel, which is secured by means of a large headed screw. The knob is provided with a pointer which moves over the scale marked into degrees. It is so arranged that when it is pointing at 0 degrees the planes of the two variometer coils are the same, at 90 degrees they are at right angles, and at 180 degrees they are again coincident, but the direction of the winding of the moving coil is then naturally reversed.

Condensers

The three condensers, C, D and E, shown in Fig. 2, are made as follows:—The condenser C is made from a ¼-plate photographic negative with the film removed, the thickness of the plate being about .055 in. A piece of tinfoil is secured to each side of the plate with a little shellac varnish, the foils overlapping for an amount of 1½ in. by 4 in. The condenser D is also made from glass plates and tinfoil, the glass being the same kind as used in the first condenser. In this case ten pieces of tinfoil are required, the area of overlap being 3½ in. by 2 in. The condenser E is made from mica and copper foil, the mica being about .004 in. thick. Fifteen copper plates are used, the area of overlap being 1½ by 2½ in. The actual construction of the condensers is of little importance so long as the resultant capacities are approximately C = .0003 μF. D = .003 μF., and E = .04 μF. Condensers of these capacities could, if desired, be bought ready-made.

Buzzer and Resistance

Any buzzer will be suitable for the wave-meter, but one having a high note is preferable. The connections must be altered, if necessary, so that they correspond to those shown in Fig. 2, that is, the current flows through the point contact to the armature and thence through the coils in series, as shown.

The resistance R is connected across the buzzer coils as in Fig. 2, and is necessary to provide a path for the energy stored up in the coils to discharge itself, so that it will not form an arc across the contacts when the buzzer operates.

If this took place the energy in the variometer coils would flow across the conducting arc instead of

Switch Q. (FIG. 1).
This is an ordinary double-pole change-over switch and is used to

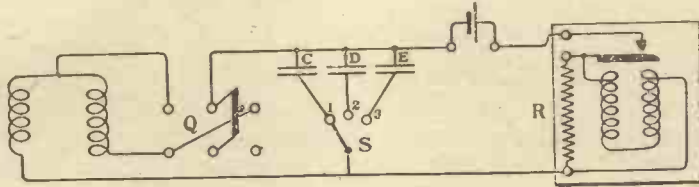

Fig. 2. The wave-meter circuit.

charging up the condenser, and the wave-meter would not emit a wave of any definite wave-length.

To find the correct amount of resistance wire, first set the buzzer working by means of a battery. When it is going, connect a piece of resistance wire across the coils. If the resistance is too small, the buzzer will stop and the length of resistance wire must be increased till the buzzer will work properly. It will probably be found that 2 or 3 feet of about No. 30 Eureka wire will be sufficient. The resistance should be non-inductive, and may be wound on a wooden former in zig-zag fashion, or may be doubled upon itself and wound upon a small bobbin, in which case insulated resistance wire must be used.

A pocket lamp battery or dry cell may be used to work the wave-meter buzzer, and it is very convenient to fix this inside the box.

place the variometer coils in either series or parallel. It will be seen, of course, that when the switch is closed in either position it auto-

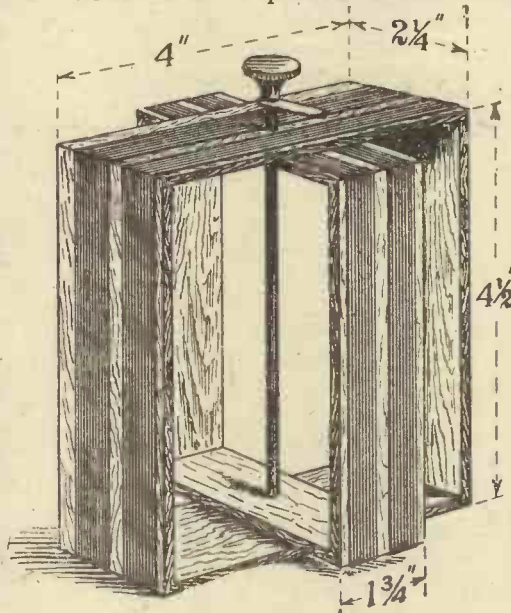

Fig. 3. The variometer.

The Switch S. (FIG. 1).

This is merely a three-way of the usual type switch for the purpose of selecting the required condenser to give the desired frequency. The method of connection can be seen quite clearly from Fig. 2.

matically switches on the buzzer.

Calibration and Use.

It will be seen that six different ranges of wave-lengths are available, that is, two ranges with each con-

denser in circuit dependent upon the variometer coils being either in series or parallel. These are so arranged that there is a good margin of overlap between each, and a continuous range is obtainable between 300 and 9,000 metres. The instrument is best calibrated against a standard instrument if such can be obtained. The standard meter is set buzzing on the lowest wave-length, and the receiving set is tuned until loudest signals are obtained. The standard wave-meter is then switched off and the new one set buzzing and adjusted until loudest signals are once more obtained on the set.

The reading of the variometer pointer is then noted and corresponds, of course, to the wave-length on which the standard instrument was working. This process is repeated for a series of wave-lengths, for example, in steps of about 100 metres, that is, 300, 400, 500 metres, etc., until all the range has been covered. In order to find intermediate wave-lengths it is advisable to draw a number of calibration curves by which these may be determined. In the absence of any standard wave-meter, the instrument may be calibrated by stations of known wave-lengths, and also more especially by those that

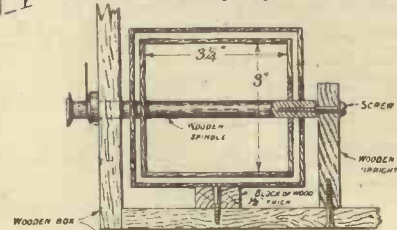

Fig. 4. The method of assembly.

transmit calibration signals, in a similar manner to that where a standard meter is employed.

NOTE.

ALTHOUGH in reply to our page of questions 90 per cent. of our readers expressed their indifference regarding the quality of the paper used, we have decided to print "MODERN WIRELESS" on superfine paper, while at the same time giving a very generous allowance of text matter.

A very small proportion of the present issue is printed on the former paper.

TYPES OF TUNING INDUCTANCE

By R. W. HALLOWS, M.A.

Are you using the best type of inductance in your tuner? This article explains the merits and demerits of the various kinds and will be found helpful to every new devotee of the art.

THERE are many types of tuning inductance, each of which has both its advantages and its drawbacks. None of them is quite ideal, for it is impossible to incorporate all the strong points in any par-

8. Easiness of operation.
9. Robustness.
10. Possibility of varying the degree of coupling very finely.

Some of the qualities mentioned are really corollaries of others. If, for example, we have low self-capacity we shall probably find also

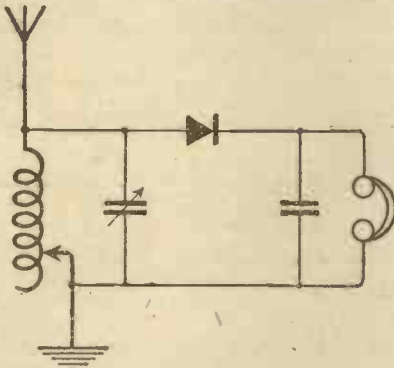

Fig. 1. The simplest slider tuner, with variable condenser for fine tuning.

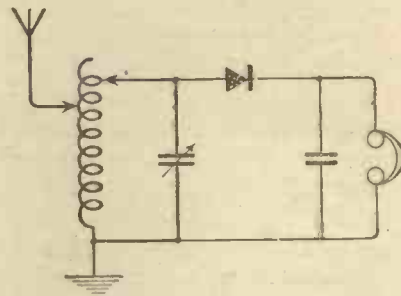

Fig. 2. A two-slide tuner.

particular design without at the same time including some of the weak ones. The perfect tuning inductance would possess to the highest possible degree all the following qualities:—

1. Low self-capacity.
2. Great inductance efficiency.
3. Compactness.

high inductance efficiency. Small ohmic resistance again will aid selectivity, since the resonance curve of any tuned circuit is least flat where resistance is at its lowest. Others, on the other hand, are practically opposites, difficult to reconcile in one and the same inductance. Thus low resistance means stout wire, which is a foe to compactness; nor can

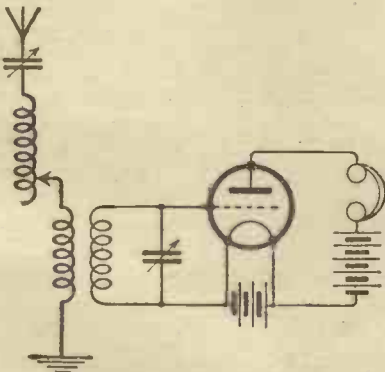

Fig. 1a. A single-slide tuner used as a loading coil.

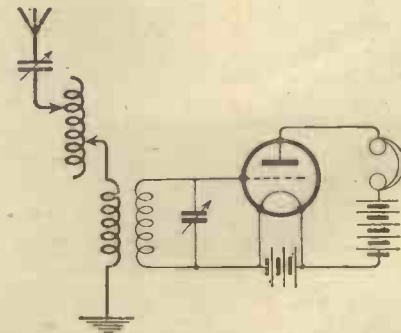

Fig. 2a. Two-slide tuner used as a loading coil, the sliders being adjusted to give a minimum "dead-end" effect.

4. Small ohmic resistance.
5. Wide range of wavelengths.
6. Absence of dead-end effects.
7. Selectivity.

a wide wavelength range be covered by any coil unless we employ sliding contacts or a selector switch and tappings, either of which

entails the presence of dead-ends at the majority of settings.

The simplest of all tuners, and one that is probably more used in this country than any

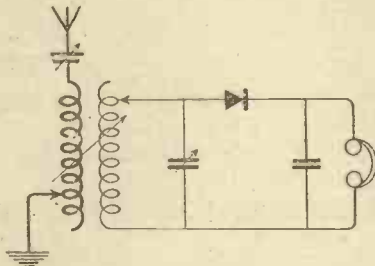

Fig. 3. Loose coupler with slider of each coil.

other, since it is fitted to so many crystal sets, is the single-layer coil provided with one slider, which is used generally in circuits such as that shown in Fig. 1. Though not of much use as the main A.T.I. in valve sets, it can be employed very handily as a help to fine tuning if connected up as shown in Fig. 1a. If made use of in this way it enables one to adjust the tuning so that the maximum amount of inductance and the minimum amount of capacity are present in the circuit on any wavelength. Once a transmission has been picked up condenser knob and inductance slider are worked one against the other until the former is at its minimum and the latter at its maximum setting. This circuit will be found particularly advantageous on short wavelengths.

A development of the single-slide

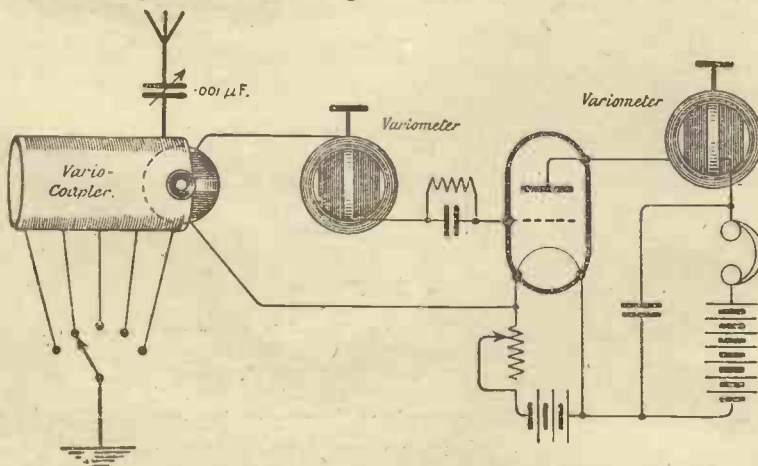

Fig. 4. Variocoupler used in an American circuit.

tuning inductance is that provided with two moving contacts. This has two very distinct advantages over the simpler type. In the first place such a coil becomes an auto-transformer, the coupled circuits both making use of certain turns in common. The aerial circuit and the detector circuit are each tuned by means of their sliders, and as the latter requires more turns than the former a slight step-up effect is obtainable.

The second advantage follows from the first. As each circuit is tuned separately to the resonance point increased selectivity is obtained. The double slide tuner can be used direct as an inductance for the valve set, but is not often so employed.

From the auto-transformer, the next step is the transformer proper, consisting

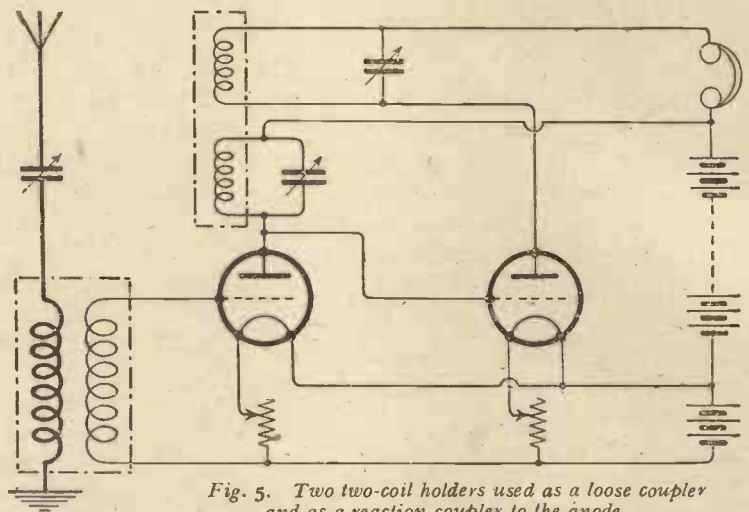

Fig. 5. Two two-coil holders used as a loose coupler and as a reaction coupler to the anode.

of two single-layer coils sliding one within the other. The outer of these usually forms the aerial tuning inductance, the inner, wound with many more turns of finer wire, the closed circuit inductance.

For crystal detector work the loose-coupler, as it is called, is probably the most efficient of all tuners, and for reception on the short wavelengths there are few to beat it for use with the valve set. On broadcasting wavelengths it can be used during the prescribed hours only as A.T.I. and C.C.I., but at other times and on other waves the inner sliding coil can be wired up so as to form the reaction coil.

One thus obtains a very sensitive tuner indeed, the degree of coupling being almost infinitely variable and reaction being provided direct on to the aerial tuning inductance.

All of these tuners make use of the single-layer coil, whose self-capacity is of the lowest, since the potential difference between adjacent turns is so small as to be almost negligible. They have, however, one quality, which, in theory at any rate, is thoroughly bad. Most of them cover a considerable band of wavelengths, tuning being done by taking in a greater or less number of turns as required by means of tappings or sliding contacts. Suppose that we are using a coil containing 300 turns, and that for the particular transmission that is coming in we are actually making use of 197 of them. Oscillations surge past the slider or the tapping point in use into the remaining 103.

The coil is thus divided into two unequal parts, each of which has its own resonance frequency. Theoretically, this might make sharp tuning impossible. Actually its effects are not so noticeable as might be expected, though they must lead to a certain loss of efficiency.

Other kinds of coils are made to cover only narrow bands of frequencies, but so far as I know only one firm applies the same process to the single-layer inductance, and then only for four coils. Yet there is no reason why this should not be done; personally, I make considerable use of a set of single-layer coils, provided with plug and socket mountings, each of which covers about the same wavelength range as a single Igranic coil. In this way one does away altogether with dead-end effects, and the coils are so easily slipped into place that to change one for another is very little more trouble than to move a slider or a selector switch arm.

Two other kinds of tuning inductance which make use of single-layer windings are the variocoupler and the variometer. Both of these rose to popularity in the United

States in the first place, and it is only quite recently that we have seen much of them over here. The variocoupler is simply another form of the loose-coupler, the main difference between the two being that in the latter the secondary coil slides in and out of the primary, whilst in the former it takes the form of a ball-shaped rotor, variations in the degree of coupling between the two coils being obtained by rotating this upon its axis. When the two sets of windings are concentric the coupling is at its tightest. When they are at right angles to one another the degree of coupling is reduced almost to zero.

The variometer works on quite a different principle. Like the variocoupler, it consists of a stator and a rotor, but the windings, instead of being separate and distinct, are connected together in series. When the rotor is so placed

that the two sets of windings are concentric and in the same direction the instrument has its maximum inductance value, hence it is tuned to the longest wavelength for which it is wound. As the rotor is turned from this position the wind-

ings aid each other less and less, until finally when the coils are in opposition the inductance value is at the minimum, and the wavelength to which it is now tuned is the shortest with which the instrument can deal. A very fair wavelength range is obtainable in this way, variometers suitable for broadcasting reception being usually capable of covering a band between 300 and 530 meters. Tuning in the case of a well-designed instrument is particularly fine.

The variometer can be made use of in a variety of ways in the set. It may be connected up to form the aerial tuning inductance, in which case no variable condenser is usually required, though one may be wired in parallel to enable it to cover a wider range of wavelengths. Another use for it is to replace the anode inductance with tuned plate coupling between high-frequency amplifying valves.

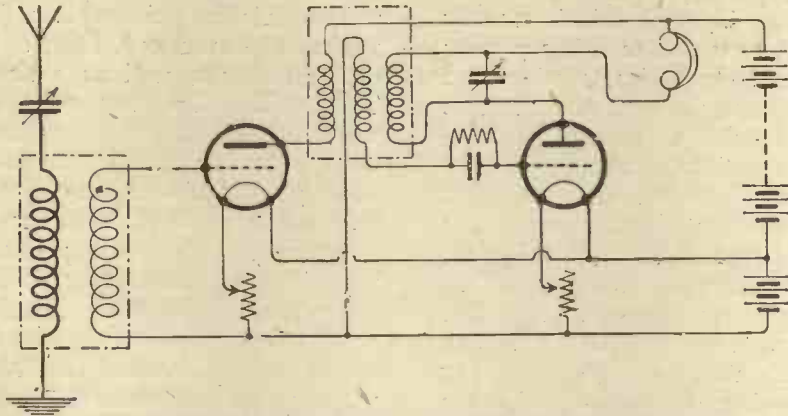

Fig. 6. A three-coil holder used for a high-frequency transformer with reaction coupled to it.

For both of these purposes it will be found excellent.

Americans, who require very selective circuits in order to be able to tune out unwanted transmissions—there are 700 broadcasting stations in the States all operating on wavelengths very close to one another—have developed the use of the variometer as an aid to fine tuning. A typical single-valve circuit designed for this purpose is seen in Fig. 4. It will be noticed that one variocoupler and two variometers are used. One variometer accomplishes the fine tuning of the grid circuit, the other deals with the plate circuit, a reaction effect being obtained when the two are in resonance.

The tuning inductance most commonly used for work with the valve set in this country is probably the two- or three-coil holder provided with basket, Igranic, or other multilayer coils. If the design is good this is a very satisfactory form of tuner, since it has a great many of the desirable qualities to which we referred at the beginning of this article. The coils are specially wound to ensure low self-capacity; they give great inductance efficiency in small compass, their resistance is not high, and they are reasonably robust. Each coil covers only a moderate band of wavelength, but as they are readily interchangeable this is not a matter of great moment. The fact that there are no tapings eliminates dead-ends, with their attendant disadvantages. Coupling can be varied within considerable limits; hence when the tuner is used in combination with variable condensers capable of fine adjustment it becomes respectably selective.

There are, however, several points open to criticism in many types of double- or triple-coil holders. Some of them are provided with arrangements of bevel gears for effecting the movement of the coils in response to the turning of a knob. The idea is excellent in itself, but unfortunately it is not always well carried out. The pinions may be too small or made from soft metal. The result in any case is often that the movement develops backlash and jerkiness when the stand has been in use for some time. One design of three-coil stand has the holders for the moving coils mounted on brass pillars which act as pivots for them; the tops of the pillars are held by a brass plate. Owing to faulty design some tuners of this type develop short circuits between coils *via* the pillars and the metal plate when they have had a little wear.

I had three of the same make which broke down one after another in this way.

But the fault that is common to nearly all tuners of this kind is that the coupling can be varied only by making changes in the angles between the faces of the coils. The sole movement possible increases or decreases the V-shaped opening between them. This is not sufficient to allow the smallest and finest adjustments to be made easily.

One firm has brought out an entirely different design. In this the holders for the moving coils slide upon horizontal brass rods. The fixed coil is in the middle, and the others may be moved independently nearer to it or further away from it. This is an improvement, since a larger amount is required than with the pivot-fitted stand to make an equal variation in the degree of coupling. But, even so, the tuner is not quite perfect. What is required is that the moving holders should be capable of a turning as well as a sliding movement. This could be done very easily by fitting pivots to the holders of the design mentioned. With such a tuning stand one can obtain rough tuning by means of the straight-away movement of the coils and then make final minute adjustments by turning each very slightly upon its axis. Something of this kind has been accomplished by the Igranic triple stand which uses gimbal-mounted coils.

For use in the valve set that is intended for work upon short and medium waves the two-coil stand is probably the most convenient type of tuner. The three-coil holder cannot be used in the ordinary way on broadcasting wavelengths, since it is not permitted to couple the reaction coil to either A.T.I. or closed circuit inductance. Even if such use were permitted, a very large number of experimenters would find the adjustment of the three coils a matter of extreme difficulty, as the slightest variation in position of either moving coil upsets the adjustment of both reaction and coupling. It can, however, be mounted most successfully as a high-frequency transformer (see Fig. 6), two of the holders being used for the primary and secondary coils, and the third taking the reaction coil.

With a pair of two-coil stands one has all that one wants as the foundation of a large variety of circuits. One is used for A.T.I., the other for the tuned anode inductance and the reaction coil that is coupled to it.

THE "CRYPTO" COMMUTATING RECTIFIER

A description of a very successful machine for accumulator charging from A. C. Mains.

ONE of the bug-bears of the wireless enthusiast is the ever-present problem of accumulator charging: on the one hand, he may carry his battery a weary distance to a charging station or garage, where it may or may not be given proper treatment



Fig. 1. The Crypto machine.

or alternatively he may use one of the many methods of charging from the town supply.

Of the various methods, the majority are unsatisfactory, either by reason of the unreliability of the apparatus, or the messy and troublesome nature of its upkeep.

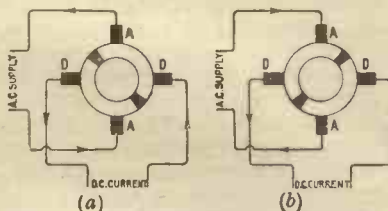

Fig. 2. Showing the principle adopted.

Of the successful methods one of the most economical and efficient is that of employing some form of rotary converter or commutator,

of which type a good example is given in Fig. 1. This is the "Crypto" rectifier, which is made by the well-known electrical engineering firm of that name.

The machine consists essentially of a synchronous A.C. motor of the induction type which runs directly off the mains, which also feed the primary of a static transformer. This transformer is bolted to the underside of the motor, as may be seen in Fig. 1. The alternating current from the low-tension secondary of the transformer is converted into unidirectional current by the action of the commutator mounted upon the shaft of the motor.

The action of rectification can be best understood from Fig. 2 (a) and (b). From this it will be seen that the four brushes bearing upon the commutator are so connected that when the A.C. reverses its direction of flow the rotation of the synchronous motor turns the commutator through 90 deg., thereby reversing the connections to the output brushes and maintaining the direct nature of the output current.

The motor is self-starting and can be switched direct on to the line, the necessary starting torque being obtained by means of a special starting winding, which is cut out automatically by a centrifugal switch incorporated on the rotor upon the motor attaining synchronous speed. This feature is novel and seems a distinct improvement on the type of synchronous motor which requires an initial twist by hand to start the machine. Another particular feature is the fact that there is no electrical connection of any sort between the high tension A.C. supply and

the cell terminals—that is to say, the set is not auto-connected. This makes it impossible for a shock to be obtained from the main A.C. supply.

A switchboard is made for use with the rectifier which makes its

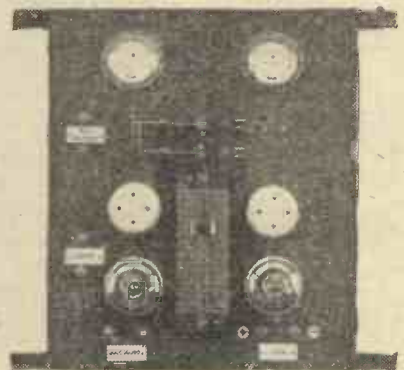
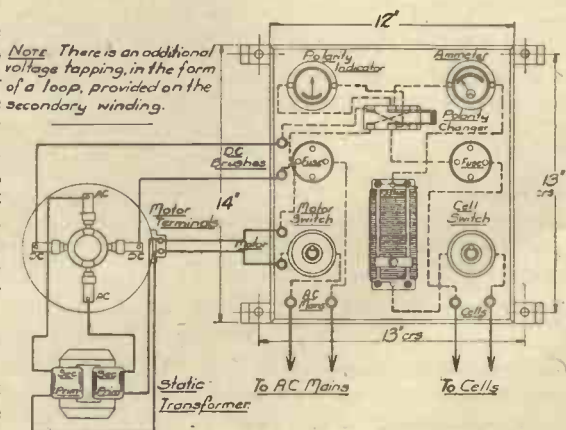

Fig. 3. The switchboard.

use a very simple matter, the connections being shown in Fig. 3. To use the set, the accumulator is connected to the "cell" terminals, and the motor started by closing the "motor" switch; a reading is then given by the polarity indicator and if this is incorrect



the "polarity" switch is changed over. The "cell" switch is then closed and the charge-rate adjusted by means of the variable resistance to the desired value, as indicated by the ammeter.

The machine is made in several sizes, ranging from a D.C. output of 15 volts 5 amps. to one of 60 volts 70 amps., and its over-all efficiency compares very favourably with that of other methods of charging. The smallest rectifier, for example, runs for 6 hours with a consumption of approximately one unit of current, and such economical charging should quickly save the first cost of the outfit.

A representative of MODERN WIRELESS recently had the opportunity of inspecting Messrs. Crypto's works at Acton Lane, Willesden,

N.W. 10, and seeing the machine both under construction and on test, and was very favourably impressed by the sound methods of manufacture employed. The motor runs very quietly and sweetly, with remarkable freedom from sparking at the brushes, each machine being adjusted in this respect, and submitted to a searching test on completion.

A good feature of these rectifiers is that even the smallest is fitted with a blower for cooling, consequently the machines will run for long periods, without over-

heating, and will stand up to very heavy duties. Several finished rectifiers were seen on the test bench, where they have to run for some hours with various definite percentage over-loads, the rise of temperature in the windings being recorded, and their resistance to ill-treatment of this sort is certainly remarkable. One of the larger rectifiers was seen running with an over-load of nearly one hundred per cent, and the sparking at its brushes was only just perceptible under this severe test:

A GLOSSARY OF TECHNICAL TERMS USED IN WIRELESS TELEGRAPHY AND TELEPHONY

(continued from p. 347.)

Generator

In wireless, confined in everyday speech to magneto-electric machines, i.e., dynamos. Sometimes (and quite correctly) extended to cover other "generators" of electric energy such as the valve or arc. Strictly, batteries also would be included, but this is not often the case.

Generators may supply direct or alternating current, the word "Dynamo" being usually confined to the former and "Alternator" to the latter. Alternators of usual commercial type work at any frequency up to 1,000. Above this, special methods of design and construction are usually employed.

Graphite

One of the forms in which the element carbon exists. Used as a detector in conjunction with galena (q.v.). Also used sometimes in the construction of resistances, and for the brushes of generators. Appearance: black, greasy, polished surface.

Grid

The control electrode of a 3-electrode valve. Takes the form of a wire spiral network or perforated plate, usually between fila-

ment and anode For action see special handbooks.

Grid Condenser

Used in some amplifier circuits to insulate the grid of one valve from the plate of the previous one. Also in some cases to cause rectification by accumulating a negative charge.

Grid Leak

A high resistance connected across the grid condenser or between grid and filament to prevent accumulation of excessive negative charge. Usually from 500,000 ohms to 10 times this amount.

Ground

An American term—"Earth" in English.

Harmonic

Has the same significance as in music. An aerial tuned to a certain frequency may also radiate waves of 3, 5, 7, etc., times this frequency, which are known as harmonics. These are specially prevalent in arc stations, and to a lesser degree in certain types of valve transmitters. The "even" harmonics (2, 4, 6 times fundamental frequency) are also generated, but

are not radiated by ordinary types of aerial.

Headgear

Two telephone receivers carried on a light headband so that they are kept in position over the ears.

Henry

Unit of Inductance.

Heterodyne

The accepted method of receiving continuous waves, depending upon the generation locally of an oscillating current of frequency slightly different from that of the incoming message. The two currents cause "beats" (q.v.) which may be audible. The local oscillations may be set up by a separate valve oscillator (Separate Heterodyne), or by a valve which also acts as a detector. This latter method (Self-Heterodyne) is sometimes referred to as the "Autodyne" or "Endodyne" method. Both these words, however, are meaningless in this connection, and it is better not to use them except in casual speech. For the comparative merits of self and separate Heterodyne reception, reference must be made to special handbooks on the valve.

(To be continued)

HOW TO CHOOSE A HONEYCOMB COIL.

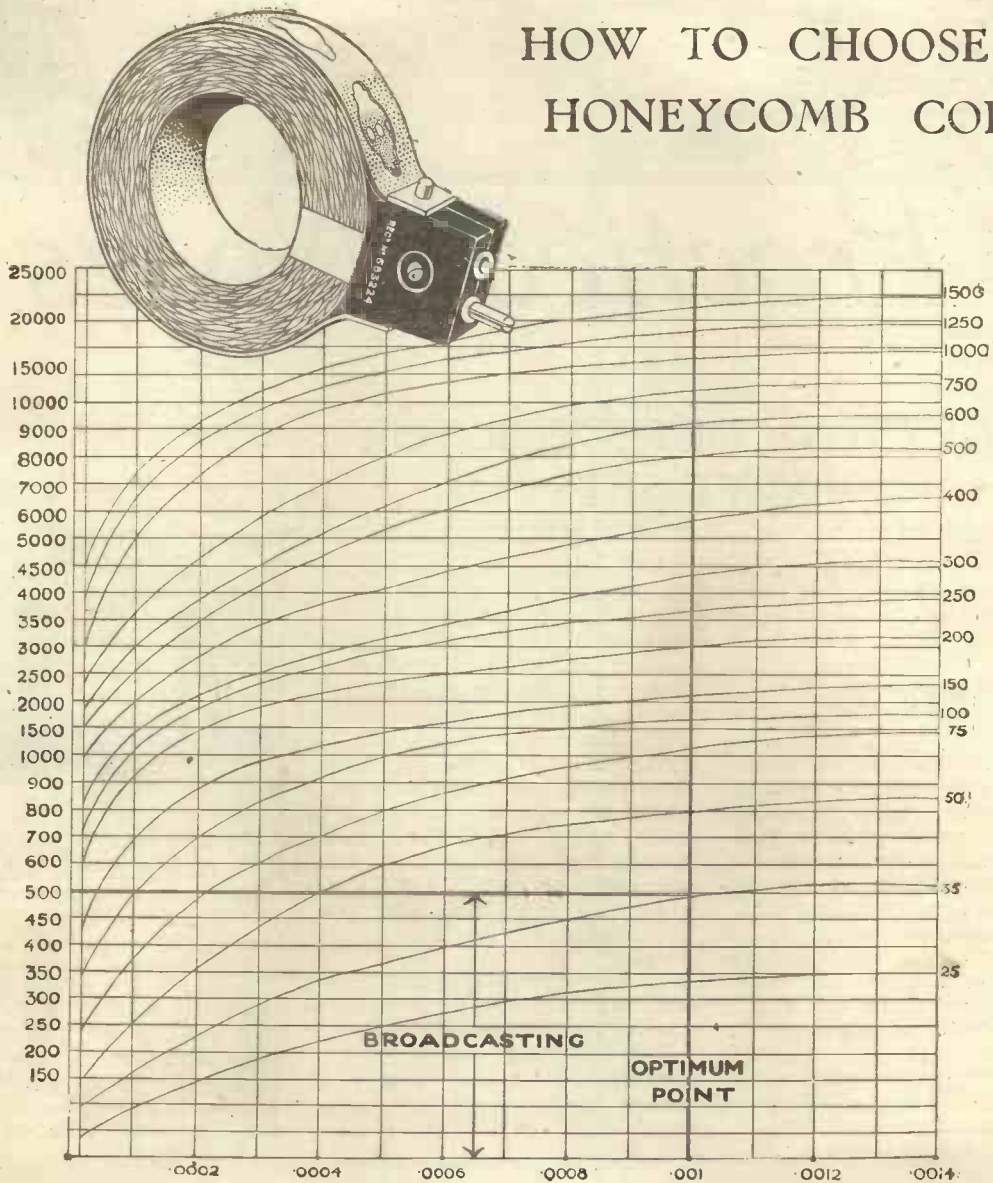

WE have received so many queries from readers asking what coil to use for a particular wave-length or wave-length range that we think the accompanying selection chart, which we publish by the courtesy of the Igranic Electric Company, will prove widely useful. The figures in the left-hand column show wave-length in metres, and those on the right the numbers of various coils. Along the bottom line are marked various capacities.

The capacity of the average amateur aerial is about .0003 microfarads, and if no variable condenser is in parallel with the coil, we can find the rough minimum wave-length to which the particular coil will tune in the aerial circuit by taking a vertical line from .0003 on the baseline to the point where it intersects the coil curve. Then a horizontal projection to the left-hand scale will give the wave-length minimum. The maximum is easily found by adding the maximum capacity of the variable

condenser to .0003 microfarads and reading from the chart. Thus a 100 coil with a .0005 microfarad condenser in parallel will tune to a maximum of approximately 1,500 metres.

For tuned anodes an approximate reading can be taken from the capacity of the anode condenser and the coil number on the wave-length. Loose-coupled secondaries are calculable in the same way. Reaction coils are best found by trial. Many other uses of the chart will suggest themselves to readers.



Practical Notes

A CRYSTAL DETECTOR FOR VALVE SETS

THERE can be no doubt that for the reception of speech and music the crystal detector is superior as a rectifier to the three-electrode valve. It rectifies all frequencies with equal efficiency, and hence distortion and "woolliness" are almost eliminated. Further, being less responsive than the valve to weak impulses, it considerably reduces the volume of partially heterodyned "mush" that so frequently accompanies transmissions from broadcasting or other powerful stations.

If your set is powerful enough to bring in any particular telephonic transmission without the use of reaction, the use of the plug-in crystal detector about to be de-

This little detector was designed to plug into the valve-holder of a rectifying panel of a set using two stages of tuned-anode high-frequency amplification, and either one or two note-magnifiers. It is extremely simple to make and most satisfactory to use.

A piece of ebonite $3\frac{1}{2}$ inches long by $1\frac{1}{4}$ wide and $\frac{1}{4}$ inch thick is laid out and drilled as shown in Fig. 1. The 2 B.A. holes shown are for the screws of the crystal cup and the supporting rod of the detector. The dimensions and distances apart are those found suitable for an old detector which happened to be lying at hand; they will probably require modification to suit such types of detector

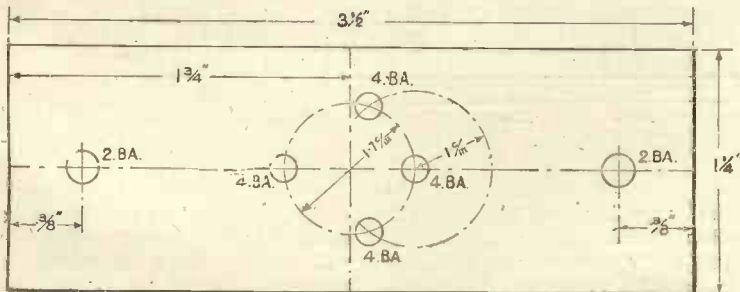

Fig. 1.—How to drill the ebonite.

scribed may be found to have an appreciable effect on the quality of the reception. There may be possibly a very slight loss in signal strength, but as the "mush" is weakened more than is the legitimate transmission, you are the gainer on balance.

as any readers who make up this little device may have by them.

The detector having been mounted, four valve pins are fixed into the 4 B.A. holes shown, brass strips connecting those corresponding to grid and plate with supporting rod and crystal cup respectively.

It is important, with Permanite at any rate, that connections should be made in this way, for if they

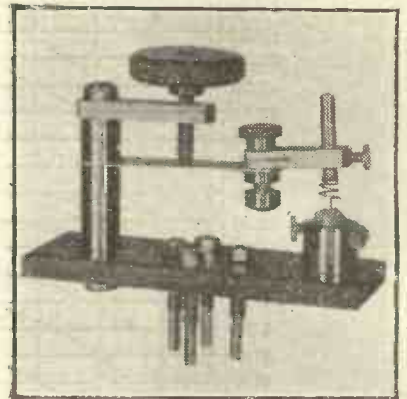

Fig. 2.—The complete detector.

are reversed the crystal will not function well. The two pins corresponding to the filament legs are left unconnected; their only purpose is to give the detector a firm seating in the valve-holder.

The detector is now complete, its appearance being as shown in the photograph. One other little

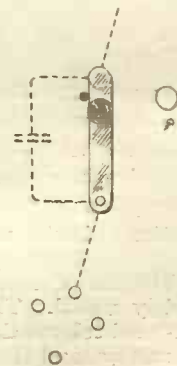

Fig. 3.—The short-circuiting switch for the grid condenser.

job, however, must be done if it is to work properly. The presence of the grid leak does not seem to matter in the least, but that of the grid condenser cuts down signal strength by more than fifty per cent. We must therefore make up

a simple short-circuiting switch for throwing it out of action.

Fig. 3 shows how this may be done. Fig. 4 gives a wiring diagram showing how the detector fits into the circuit when it is plugged into the valve-holder:—R. W. H.

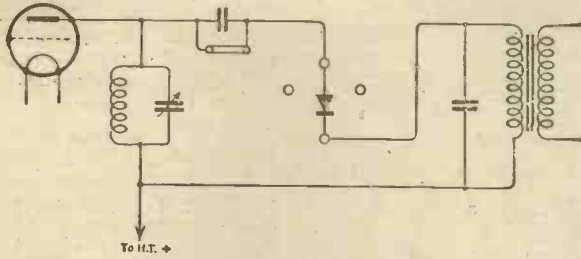

Fig. 4.—How the crystal is connected.

BACKSTAYING A MAST.

IN locations where the aerial has to be erected in a very confined space, it is very often found that it is only by sacrificing a few yards of an already short enough aerial length that sufficient room is available to backstay the mast.

Now these backstays, or stays, are of the utmost importance as they have to take the weight and wind strain of the aerial, but a simple remedy for confined spaces is to use a cross arm at right angles to

and will be knocked up by the local blacksmith for a trifling amount. It should, for a 35-ft. mast, not be less than 3 ft. in length, and the end which carries the staywire filed out to provide hitch for the wire and the two halves pulled up tight behind to prevent the wire running into the joint. In all other respects the diagram explains itself. In erecting a mast with a backstay of this type, the cross arms and stay

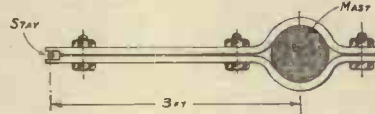

should be fitted while the mast is on the ground and the stay tightened up sufficiently just to raise the small end of the mast (i.e. the pulley end) a matter of two or three inches off the ground. When the mast is raised and the usual front and side stays secured and taut, it will be found that the backstay has then just the right amount of tension to take the pull of the aerial if the latter is of the twin wire type. Should a single wire be used as the aerial, the backstay need not have so much tension.

In practice this method of backstaying a mast is quite serviceable but it should not be attempted on a mast whose height is greater than, say, 35 ft.

G. L. M.

DRILLING PANELS FOR VALVE HOLDERS

WHEN mounting holders for 4-pin valves on panels much time can be saved and a neater job made of the finished instrument if a jig is used for drilling the panel.

Such a jig is shown in the diagram, which, it should be noticed, is drawn to actual size. A piece of mild steel should be obtained and marked out with dividers and scribed in accordance with the dimensions shown, a suitable thickness for the gauge being $\frac{1}{4}$ in. The four holes for the valve-pins and the centre hole being drilled carefully so that they are truly at right angles to the surface of the jig.

The jig should be used as follows: Having decided on the position of the valve-holders, drill a hole to take a 4 B.A. bolt in the centre of each valve position, bolt the jig to the panel with the plate and grid positions aligned as required and drill through the panel with the jig in position. The diameter of holes shown in the jig for the plate, grid and filament legs is large enough for the standard flanged

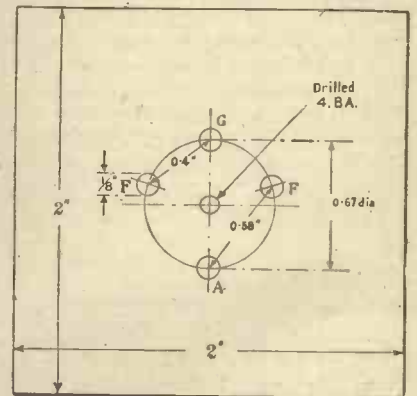

The drilling chart.

type of four pin holder. Some makes of holder, however, employ larger diameter pins, and in this case the holes in the jig should be large enough in diameter to pass freely the particular size of valve leg which is being mounted.

G. L. M.

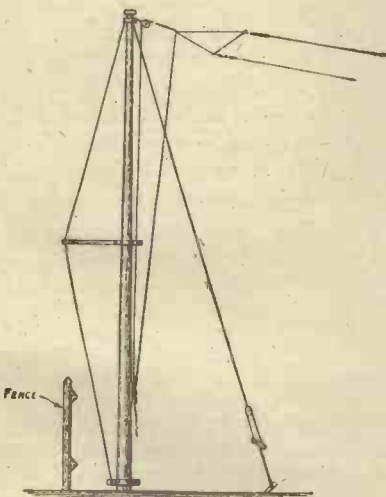

the mast as shown in the diagram. This arm, which is made in two halves to clamp on to the mast, should be made of malleable iron

TIGHTENING MAST STAYS.

MANY experimenters have no doubt found that to obtain the correct amount of tension on the mast stays usually offers some little difficulty. Where the aeroplane type of wire strainer is used the length of wire which can be taken up is very small unless a very large and heavy size of strainer is employed, and unless the barrel is secured from rotating, sooner or later the strainer slacks off and the stay goes out of tension. The attached diagram, which is to all intents and purposes self explanatory, shows a very simple and at the same time highly efficient type of strainer, which has been in use on the writer's mast for over 3 years. As will be seen, it is the adaptation of the bell tent guy strainer to wireless purposes. No dimensions are given in the drawing, since they will vary according to the various conditions under which they are used, but it is important that the distance from the centre line of the block which terminates the stay proper to the centre line of the ground eye should not be less than 3 ft. in order that sufficient slack may be obtained when actually tightening up. The sliding block should be of ample size as it has to withstand two opposite forces in tension and should be of the wedge shape as shown, in order that sufficient purchase may be obtained on the rope which passes through it.

Whether the actual stay wire is

a single strand or wire ropes it is imperative that the strainer should consist of stranded wire rope, not only in order that sufficient

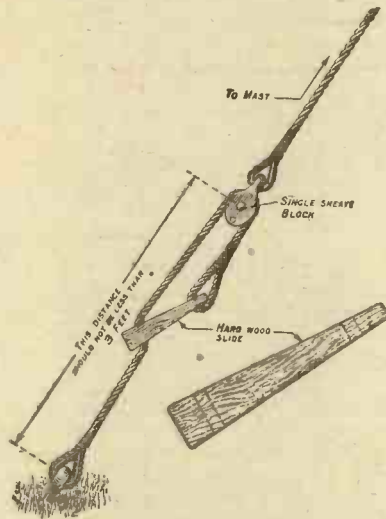

A cheap tightener.

flexibility may be present, but if ordinary rope is used the whole utility of the strainer will be destroyed owing to the contraction and expansion due to rain and sun.

If the following few hints are carried out, the reader will find that he has a very efficient stay tightener at a very low cost, and, moreover, one which is very quickly and easily adjusted.

G. L. M.

range from 2 B.A., which is quite a large screw, down to the small No. 6.

B.A. brass screws are usually employed in wireless work, and according to whether the heads are to remain "proud" on the panel, or are to fit flush with it, they are cheese-head or counter-sunk head respectively.

S.W.G. stands for standard wire gauge, and it is in terms of this gauge that the thickness of sheet brass and copper is given.

In the case of wire it refers to the diameter of the conductor comprising the wire. Thus "7/22 S.W.G." means that a stranded cable with seven strands each of 22 S.W.G. is indicated. Strip or sheet brass and copper used in wireless work are usually about 16 S.W.G. where considerable strength is required, and about 24 S.W.G. for light jobs; 22 S.W.G. is suitable for building up laminated switch arms.

16 S.W.G. is about $\frac{1}{16}$ in. thick; 22 S.W.G. and 24 S.W.G. are respectively just over and under $\frac{1}{8}$ in. thick.

The thinner sheets are usually supplied in the form of rolls of quite moderate width, and are called "foil," of varying thicknesses, given in thousandths of an inch; those in the region of $\frac{1}{1000}$ being suitable for the making of fixed condensers.—R. L. R.

A COMBINED H.T. AND L.T. PLUG.

IF from some cause or another a valve is destroyed, a very useful plug can be obtained from the 4-pin plug in its cap.

Assuming a valve has been broken, run a sharp edged file round the glass where it enters the cap, and heat for a moment in a gas flame when the bulb will crack and come away from the cap. After removing the electrodes and their stem, the cap of the valve can be removed by placing in a vice and making a careful saw cut as shown in Fig. 1, (next page), across the wide portion of the cap care being taken not to cut into the

THE NOMENCLATURE OF SCREWS AND METAL SHEETS; B.A. AND S.W.G. EXPLAINED.

B.A. signifies that a screw is made according to the specifications of the British Association as regards the number of threads per inch and the depth and shape of the thread for any given size, e.g., a 4 B.A. screw has $38\frac{1}{2}$ threads to the inch, which are .0312 inches

deep. Whitworth screws of the same size have only 32 threads to the inch.

The size of the screw is given by its index number in a scale ranging from 0 down to the minute screws used by watch-makers. The sizes in common use in wireless work

ebonite plug. The four leading out wires can now be cut off and unsoldered from the pins.

A useful four-way plug is now obtained. Many uses for this will

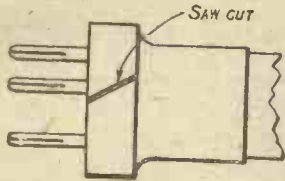

Fig. 1.

no doubt be apparent to the reader, but one adaption is for a combined H.T. and L.T. plug, as a plug of this description, owing to the unequal spacing of the pins, is "fool-proof." When the 4-pin

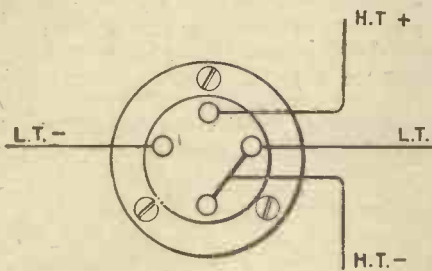

Fig. 2.

plug is removed, 4 small holes, through which the connecting wires to the valve electrodes passed, will be seen on the top surface, these holes passing through the brass pins to the point where the saw cut commences. These holes should be slightly enlarged in order to insert small flexible wires for connection to the batteries.

If a 4-pin holder is now mounted on the receiver a neat battery plug and socket is obtained. The connection of the leads is largely a matter for the individual requirements of the reader, but a suggested arrangement is shown in Fig. 2, and in the valve plug Fig. 3.

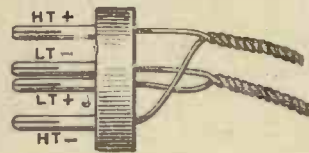

Fig. 3.

In securing the leads to this plug, after passing through the 4 pins the wires should each be taken round each of their respective pins, as near to the underside of the ebonite base as possible and neatly soldered.

G. L. M.

means of a 4BA cheesehead nut. The whole is then mounted on a piece of ebonite of suitable size from which the plates are separated by means of washers being placed on the holding down screws. The gap between the points should be about equal to the thickness of a visiting card and the switch arm should be adjusted to make a good rubbing contact with the plate connected to earth. The construction of the other small contact and other details are apparent from the sketch.

E. J. H.

NOTES ON TUNED ANODES

NEARLY every edition of MODERN WIRELESS mentions tuned anodes: these notes particularly refer to diagram 8, page 190, of the April edition. This circuit has been found excellent in every way, but to those who have not tried it these notes may save a certain amount of condenser twiddling whilst making the initial search for signals.

The following coils have been tested and found to give satisfactory results with a .002 variable condenser in parallel. All these coils were tested in pairs on a circuit embodying two high-frequency valves and a detector valve.

Wave Length	Coil	Remarks
300-500	70 turns 32 SWG, SSC wound on a 2 in. diam. pill-box. No. 5 Oojah pancake coil.	Calling the smallest coil of the set No. 1.
	No. 75 Igranic. No. 75 Burndept.	
600	No. 6 Oojah.	Setting on .002 condenser approx. 20 degrees.
1,000	No. 7 Oojah.	Setting on .002 condenser approx 15 degrees; for The Hague.
2,000-3,000	No. 500 Igranic.	Setting on .002 condenser approx. 90 degrees for FL.

For the Broadcast wavelengths reaction must be applied to the anode coil. If the set cannot be stopped oscillating, try connecting the HF grids to LT positive, or

A NOVEL EARTHING SWITCH

THE ordinary single-pole earthing switch has the disadvantage of being no protection against lightning whilst the set is in use unless a separate multi-gap protector is fitted. The switch illustrated combines the advantages of both. It has the added advantages that it is inexpensive and easily made by the average experimenter.

First take a piece of fairly heavy gauge brass 3 inches by 1 1/8 inch, and drill four 1/4 inch holes across the centre, each separated by 1/4 inch. Suitable holes having been drilled for the terminals, countersunk holding down screws and switch-arm pivot, the plate is then cut across the centre line by means of a fine fret saw. The switch-arm is of the same gauge brass as the plate and 3/8 inch wide by 2 3/8 inch long.

It is pivoted on the underside of the plate connected to the aerial by

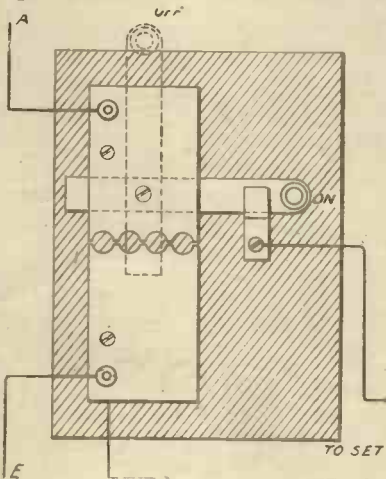

A Novel Earthing Switch.

reversing the reactance coil so that as the reactance coil approaches the anode coil signals become weaker instead of stronger. A correct adjustment will not weaken telephony. On wavelengths over 1,000 either anode coil or tuning coil reaction may be

was clearly received from this station.

The curves herewith may be of some assistance to those about to use tuned anodes. The condenser setting for a given wavelength has been plotted; incidentally, once this has been done any other wave-

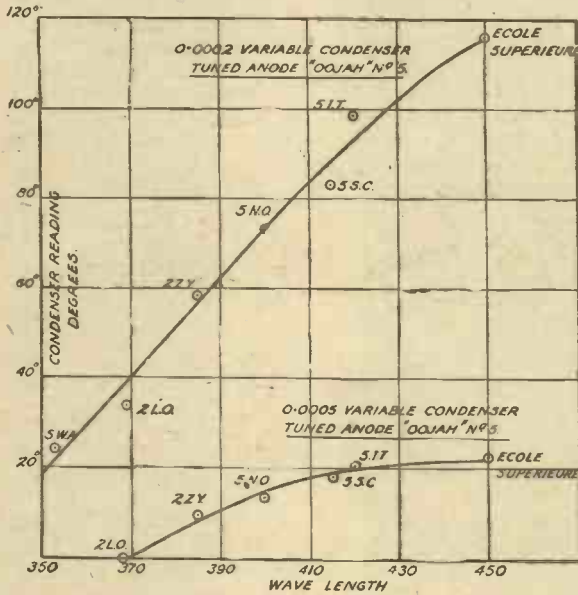

used. I find for telephony the former gives no weaker signals and allows of much more critical adjustment. As regards results, using 2 HF and detector valve, I have received a 30 watt carrier wave from an experimenter at BRENTFORD (I am at EDINBURGH), and with 2 LF switched in telephony

length may be read off and the anode coil condenser set to receive this wavelength. The reader will notice that in both curves 5IT and 5SC are off the average. Can any suggestions be made as to this? Perhaps these stations are slightly off their assigned wavelengths.

Figure 1 shows the wiring diagram, which should explain itself. When the switch-arm is on stud number one, the grid-leak is connected across the grid-condenser in the usual accepted manner for

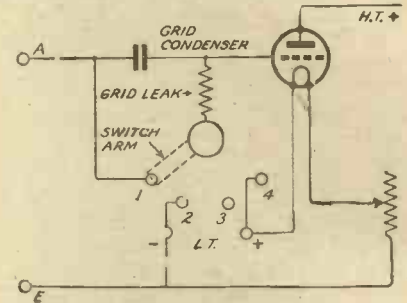

Fig. 1.—The wiring diagram.

a detector-valve which does not employ high-frequency amplification.

When the switch-arm is on stud number two the grid is given a negative potential, and can be successfully used when high frequency amplification is employed.

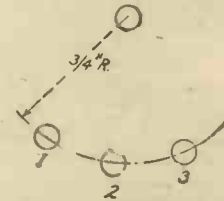

Fig. 2.—A simplified method.

By placing the switch-arm on stud number four the grid is given a positive potential, and this frequently suits a particular valve better than a negative potential.

Stud number three is blank and is not connected at all, and is only inserted between the negative and positive studs in order to avoid

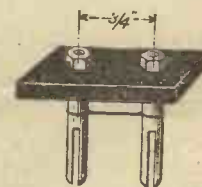

Fig. 3.—The plug connection.

HOW TO CONTROL THE POSITION OF THE GRID LEAK

THE following is a description of a simple switch, which can be fitted to almost any existing panel so that the grid-leak may be controlled in its relation to either the grid-condenser or to the grid itself; when H.F. amplification is employed the latter will be found exceedingly useful, as a positive or negative potential can be applied to the grid with the least possible trouble. Some valves detect with far greater

efficiency when a positive potential is applied to the grid, while other valves require a negative potential in order to get the maximum value out of them.

Requirements:—	s.	d.
4 studs with nuts and washers complete	0	6
1 laminated switch-arm and knob	1	6
Total	..	2 0

short-circuiting the low-tension battery.

The actual work of drilling the panel has not been described, as this has been done in previous issues of this paper. The time taken by the writer to fit the switch complete and solder the

connections was less than twenty minutes, but it has repaid itself a thousand-fold.

If there is not sufficient room to spare on the panel for the addition of a knob and switch-arm, the following plug and socket method is to be recommended, and has the further advantages of doing away with stud number three (Fig. 1), and it costs less, which is in many cases a consideration.

Requirements:—

	d.
4 valve legs, 1½d. each	6
2 valve pins with nuts and washers, 1d. each	2
1 piece of ebonite 1½ in. by ¼ in. by ¼ in.	—
1 piece of 22 gauge copper wire 2 in. long	—
Total	8

The last two items will no doubt be found in the scrap-box.

The four valve-legs are inserted in the holes drilled at A, 1, 2, 3, Fig. 2, with a radius of ¼ in.; wire-up and solder the connections as shown in Fig. 1, except that the positive terminal is now connected to valve leg number three.

The plug is made by drilling two holes in the piece of ebonite ¼ in. apart, the valve-pins are screwed well home, and the piece of wire is soldered to the two pins underneath the ebonite, as shown in Fig. 3.

It is, of course, understood that one pin of the plug is always to be in valve-leg A, to which the grid-leak is connected; the other pin can be inserted in any of the other three legs as required.

A. C.

With perseverance you have the satisfaction of knowing when a steady light results that your contact is as it should be throughout the whole length of your coil, and this point in the construction of your set will trouble you no more.

H. B.

A TIP FOR WINDING TRANSFORMERS

WHEN transformer coupling is used in a high frequency amplifier having two or more stages it is extremely desirable that all the transformers should have identical numbers of turns. To obtain the necessary exact similarity it is usual to attempt to count the turns with accuracy as they are wound on, but as the winding process is usually done at a fairly high speed in some sort of mechanical winder mistakes are very prone to occur. Errors of four or five turns are easily made in the counting.

To ensure that all the transformers of the same nominal size shall have precisely the same number of actual turns it is an excellent plan to wind them all simultaneously. For example, suppose it is desired to wind two transformers of the flat disc (interchangeable) type of say eighty turns. Drill a 3 BA hole in the centre of each ebonite former, slip them both on to a six inch length of 3 BA threaded brass rod and clamp them in the middle of the rod with a couple of nuts.

Grip the rod in the chuck of a hand drill (or in a lathe, of course) whose handle is firmly held in a vice, and winding can be commenced by revolving the gear-wheel of the drill and feeding a wire to each transformer. This necessitates the use of two bobbins of wire, and also the running of two wires through the fingers. This last is quite easily managed if one of the wires is allowed to run between the first and second fingers, and the other between the second and third fingers of the left hand, the right hand being used to turn the drill.

In this way perfect uniformity can be attained without the necessity for very accurate counting.

G. P. K.

A SIMPLE METHOD OF TESTING THE SLIDING CONTACT BY SIGHT

IT has been found that it would be a great advantage to have a visible indication of how your slider is making contact on the coil. This contact should be as near as is possible even and con-

sistent throughout the length of the coil for perfect tuning. This, however, is quite a difficult task to accomplish and extremely careful workmanship is required. On the other hand, it would be a great help actually to see what sort of contact is taking place, and it is well worth while before putting your set into use to try the simple

experiment explained in the diagram below. Adjust an ordinary battery to coil as shown and place the plunger on the first turn of the coil, then place the wire end on the

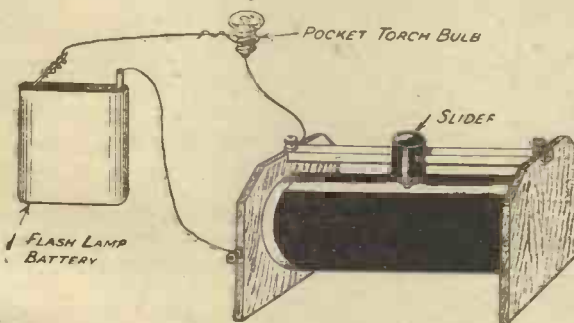

How to test the sliding contact.

plunger rod and the bulb will light. Keep the wire end in this position and slowly move the plunger along the coil. If the contact is good throughout a steady glow of light will result, but if the contact is bad in places you will have a fluctuating light and probably in some places no light at all. This means that your adjustment needs improving.

HOW TO CONSTRUCT A COIL-WINDING MACHINE

WINDING coils by hand is a tedious and uninteresting operation beset with many difficulties, and the work is not always satisfactory when completed. It is well worth while for those anticipating making one or more coils, to go to the trouble of first making a winding machine,

for the revolving coil clamp. This angle-piece slides backwards and forwards in a groove cut in the base, and should be so made as to take a coil from 3 in. to 12 in. long. It is clamped into position by means of a wing nut and bolt. The coil is placed in position by fitting the ends into the grooves of the revolving

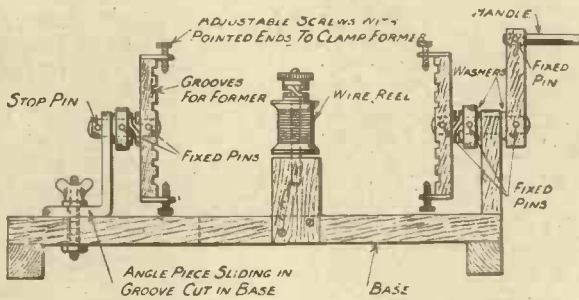

Fig. 1.

simple in construction, at a very small cost. The machine described in this note has many advantages over the several types which have been made, one of its principal

clamps each end (see Fig. 2A). These clamps are made of 2 pieces of wood about 8 in. by 1 in. by $\frac{3}{8}$ in. thick. The grooves are cut about $\frac{1}{8}$ in. deep; the 2 inner grooves

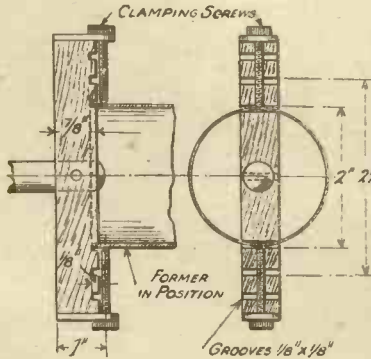

Fig. 2A.

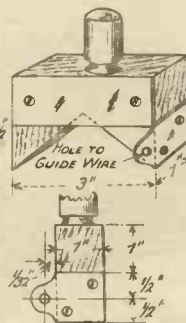

Fig. 2B.

assets being that it will wind a coil of any diameter or length. The diagrams give the method of construction.

Fig. 1 shows the complete machine. At the left-hand end there is an angle-piece, which acts as a bearing

should be 2 in. apart, and the other grooves spaced at intervals of $\frac{1}{2}$ in. apart, or in $\frac{1}{4}$ inches if desired, to take coils ranging from 2 in. to 6 in. diameter.

When the coil is adjusted in its grooves, push the angle-piece on

the left-hand inwards, and clamp up. Next screw the adjusting screws down on to the coil, until a satisfactory grip is obtained. The ends of these screws should be pointed to enable them to bite into the coil making a slight indentation.

The bobbin or wire reel is placed over a pin screwed into the block which is fixed to the base about central from each end. The other end of this pin is also screwed to take a knurled nut. Between the nut and the bobbin is a spring and washer. By adjusting the nut, the bobbin can work at any desired tension, giving a tight pull on the wire, or a free movement as desired when winding.

Fig. 2B is a handpiece which is used when winding, and is made of a block of wood with a knob attached. In the front, a strip of brass is screwed, and this is pressed down with the left hand on to the coil, while winding with the right. This, keeps the turns of wire close. On one end is attached another strip of brass which has a small hole drilled in it, but this must be placed lower down than the bottom edge of the wire guide. The wire is put through this hole before the winding is commenced and acts as a guide, keeping the wire in the desired position while winding.

The handle is made by pinning a strip of wood, about 1 in. by 5 in. by $\frac{3}{8}$ in. thick on to the spindle which can be made in each case of a $\frac{3}{8}$ in. dowel rod.

A WIRING HINT

WHEN wiring up a receiver of a fairly complicated type with the aid of a wiring diagram it is sometimes a little difficult to keep track of the connections which have been made and those which remain to be done. As a result, wires are liable to be omitted, and it is worth while to be a little methodical and adopt two safeguards: first, wire up the circuits one at a time, connecting, say, all the grids, then all the plate circuits, and so on, and second, as each wire is soldered in endorse the corresponding line on the diagram by going over it with a coloured pencil.

G. P. K.

A USEFUL DOUBLE-POLE SWITCH

HOW TO DRILL LARGE HOLES IN EBONITE

THE switch consists essentially of two arms insulated from each other in the manner to be described. One pole is formed by the 2BA spindle, while the other is the piece of flex wire which is pushed through a small hole drilled in the ebonite panel upon which the switch is mounted.

The switch is designed to work on the ordinary contact studs, and the arms may be arranged to work either on alternate studs, consecutive studs, or every four studs, as required. It may be used for a variety of purposes, such as series-parallel, reversing reaction coil,

in centre to ensure clearance from the spindle; *g*, an insulating washer to keep the arm *f* from the spindle—this may either be a small piece of adhesive tape wrapped round the spindle or a short length of ebonite tubing of suitable diameter; *h* is another insulating washer with a $\frac{3}{8}$ " hole through which is forced the insulator *g*. This is backed by an ordinary 2BA washer, and the whole being assembled, is screwed home by a 2BA nut.

The finished switch knob and arms are shown in Fig. 2. The spindle is to be passed through a hole in the panel and secured by two nuts upon the underside, these

IT is sometimes necessary in constructional work to drill quite large holes in ebonite panels, up to perhaps an inch or more in diameter, and the operation is one that presents considerable difficulty to the novice. The problem is quite easily solved, however by the use of the method about to be described.

First, drill a pilot hole of about $\frac{1}{8}$ inch diameter, then put through the largest drill you possess, and proceed to enlarge it by the use of an ordinary taper file mounted in a brace like a drill. Such an unconventional "drill" cuts rapidly when a fair amount of pressure is applied, and a hole of the desired size will soon be obtained.

In the case of extra large holes it may be necessary to use first a small file and then a large one, since the latter may have too large a point to enter the preliminary hole made with the twist drill.

Holes produced in this way have, of course, a slight taper, but this fact is usually unimportant.

B. M. P.

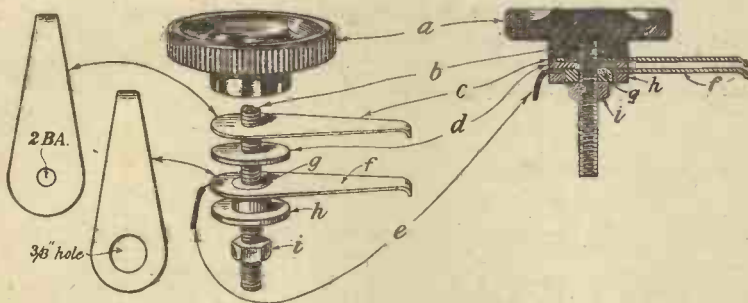

Fig. 1.—The switch in parts.

valve switching, shunting various capacity condensers across variometers, etc. Presenting a neat appearance on the panel, the instrument is well worth any trouble experienced in building it, and, of course, the cost is measured by a few pence.

Its construction should be made plain by the detailed diagram (Fig. 1), in which all the parts are lettered to correspond with the list which follows:—*a*, ebonite knob with 2BA hole tapped in centre; *b*, 2BA brass rod about 3" long; *c*, arm cut from brass sheet with 2BA hole—this arm may be soldered to the brass rod if desired; *d*, insulating washer with 2BA hole in centre; *e*, a short piece of flex wire soldered to *f*; *f*, an arm of exactly the same dimensions as *c*, but with a $\frac{3}{8}$ " hole

nuts being tightened up and locked against each other in such a position that the spindle turns freely but without slackness; this adjustment may be more easily

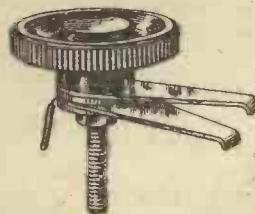

Fig. 2.—The complete switch.

obtained if a spring washer is interposed between the nuts and the panel. A circle of studs upon the panel to the required number completes the switch. N. P. G.

A RHEOSTAT FOR TWO OR THREE VALVES

IT is often convenient to be able to control the filaments of two or even three valves working on the same part of the set by means of a single rheostat. There is no reason why this should not be done, provided that all the valves are of the same type, for since all are doing the same work their requirements will be practically identical. The only difficulty is that many of the rheostats now on sale will not carry sufficient current for the purpose without overheating. The rheostat, the construction of which is now to be described, has a carrying capacity of 1.8 amperes and a total resistance of $7\frac{1}{2}$ ohms. It can thus be used for

controlling two valves of high consumption types, such as the "R" and the Ediswan, which need about .75 amperes apiece, or three valves of the "Ora" type, which do not take more than .5 amperes.

The wire most suitable for the resistance coil is No. 23 gauge, which, if good quality, should

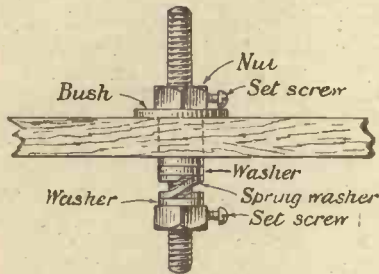

Fig. 1.—How the spindle is secured.

have a resistance value of about 280 ohms per pound. As this wire resistance works out at approximately $1\frac{1}{2}$ ohms to the yard, we shall have to wind 5 yards of it on to our coil. This cannot be done if the ordinary kind of open spiral coil is used without making the rheostat of

unwieldy size. We can, however, get over the difficulty, first, by winding the wire on a deep ring-shaped former, and, secondly, by using enamelled wire, which enables the turns to be put on quite closely.

Fig. 1 shows how the spindle, which is made of a short length of 2 B.A. screwed rod, is mounted. If the nuts above and below the panel are fitted with set screws, as shown, they will never cause trouble by working loose. The bush is of the standard type used for variable condensers, variometers, and so on. It can be bought for 2d., or turned up in the lathe if one is available.

The ring former may be turned up from a piece of hard wood, its dimensions being diameter $1\frac{1}{2}$ in., depth $\frac{1}{2}$ in., width 3-16 in. But as such a ring is not easy to wind with even five yards of wire, it is better to make a horseshoe-shaped former from a strip of ebonite $3\frac{1}{2}$ in. long, $\frac{1}{2}$ in. wide, and 3-16 in. deep. This can be done if the ebonite is placed in boiling water for a few minutes until it has become soft. It can then be bent into shape on a lamp glass or

some other round object of suitable diameter. Three holes are drilled right through it from edge to edge, one at each end of the horseshoe and one in the middle. These are to take the 6.B.A. screws, which secure it to the panel.

The windings should now be put on as closely and as evenly as possible, a space being left where the holes for the middle screw comes. The resistance may then be mounted. The contact arm is

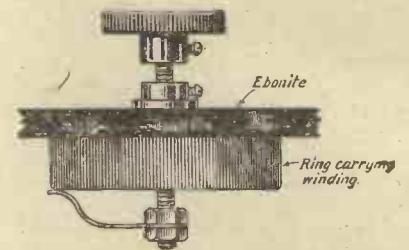

Fig. 2.—The finished rheostat.

made from a strip of springy phosphor bronze. The windings are scraped bare of enamel on the lower edge of the former so that the arm may make good contact with them as it is moved round.

R. W. H.

THE USES OF PARAFFIN WAX

PROPERLY used, paraffin wax is probably the most valuable insulating and damp-proofing compound at the command of the amateur constructor. Improperly used, it fails to achieve its object, and, moreover, does actual harm in increasing the internal capacity of windings.

The two essential points to grasp in connection with its use are these: first, remember that its specific inductive capacity is fairly high (about 2.5), and consequently, when damp-proofing a coil take care not to leave all the interstices of the winding full of wax. To avoid doing so, see that the wax is hot enough to run out freely, and drain the coil thoroughly,

giving it a little judicious shaking and jerking over a spread-out newspaper if necessary.

The second important point to bear in mind is that paraffin wax is not capable of making absorbent materials proof against moisture, but also of actually expelling such moisture as may be present in the m at the time of impregnation. To do this, of course, it is necessary to adjust suitably the temperature of the wax bath. Here a centigrade thermometer is a great convenience, for with its aid one can obtain and preserve the right temperature (scmewhat above the boiling point of water, say 140° C.), and it is then an easy matter to soak the object to be impregnated until bubbles cease to rise from it,

thus indicating that the expulsion of the moisture is complete.

Lacking a thermometer, one may rely upon guess-work, taking care not to over-heat the wax (which would result in troubles from scorching and boiling), or one may use some sort of double-boiler, such as a jam-pot standing in a saucepan, containing a liquid of higher boiling point than water, such as strong brine. Keep the brine boiling briskly and again employ the cessation of bubbling to denote the completion of the process of impregnation.

A final word: it is well worth while to spend a little more and obtain wax of good quality, whose insulation is above suspicion.

G. P. K.



SPECIAL NOTE.—All apparatus described in this section has been tested by our expert, and readers can therefore rely fully on the opinions given.

An Experimenter's Valve Panel.

FROM Messrs. McClelland and Co. we have received for examination and trial a very neat and convenient single-valve panel of the open type with terminals arranged around the edge, so useful in experimental work for testing out different arrangements of circuits, etc. This is a highly-finished article, fitted with a well-known and reliable type of filament resistance; substantial valve-holder, grid, anode, and plus and minus battery terminals; an extra refinement, and one that is of especial value in experimental work, when the risk of accidental short-circuits is so great, is provided in the form of a fuse in the filament circuit. During our test this justified its presence by promptly blowing when a rather greedy R valve was tried in the panel, the fuse being calculated for a valve of smaller L.T. current consumption. It is readily replaceable, being mounted in a spring holder on the top of the panel. The very workmanlike and short wiring is freely accessible at the back of the open panel.

On trial, the insulation resistance proved high; the action of the filament resistance what one would expect in a high-class article; and the handiness of the unit when quick changes of circuit connections were required was well appreciated. A little criticism might be offered as to the terminals fitted. It is surely unnecessary to have these

screwed up so tightly in a new instrument that two pairs of pliers are needed to loosen them; while the value of this extremely useful little panel would be greatly enhanced if larger, double terminals were fitted where most needed, for



The McClelland Panel.

making the multiple connections so common in radio circuits. Apart from this point, the general finish, workmanship and design are of a high order indeed.

A New Wave-meter.

For any serious experimenting in radio, as well as for the efficient handling of more complex receiving

circuits on the lighter side of the art, some means of tuning to a given wavelength or, conversely, of determining a wavelength are an hourly necessity. The advent of a reasonably priced but accurately calibrated wave-meter of the buzzer variety will therefore be welcomed by many: the new Mark I. Wave-meter produced by the Bowyer-Lowe Co., Ltd., an example of which has been recently submitted for our inspection and test, very precisely fills this need. The range is from 150 to 600 metres, which covers most of the transmissions of interest to the majority of experimenters and listeners-in alike. The instrument is self-contained except for a small dry-cell to operate the buzzer, and is provided with an individual calibration-chart from which any wavelength within the range can be read off with considerable accuracy. The calibration-chart received with the instrument checked up very accurately with the standard. The finish, workmanship, and design of this instrument are unexceptionable; the small high-note buzzer fitted is certainly one of the best for its purpose we have seen, being fully adjustable, easily accessible, and astonishingly economical in current-consumption, the one tested consuming only 25 milliamperes of current, so that the small dry-cell will last a long time. The tuning was very sharp, whether on valve or crystal circuits; the radiation sufficient for convenient testing with very loose coupling; and

there was a refreshing absence of those directional effects for which one well-known wave-meter is notorious. A minor criticism which will present itself to most users is the absence of a compartment for the small dry-cell: there will be an irresistible temptation to stand this in the open

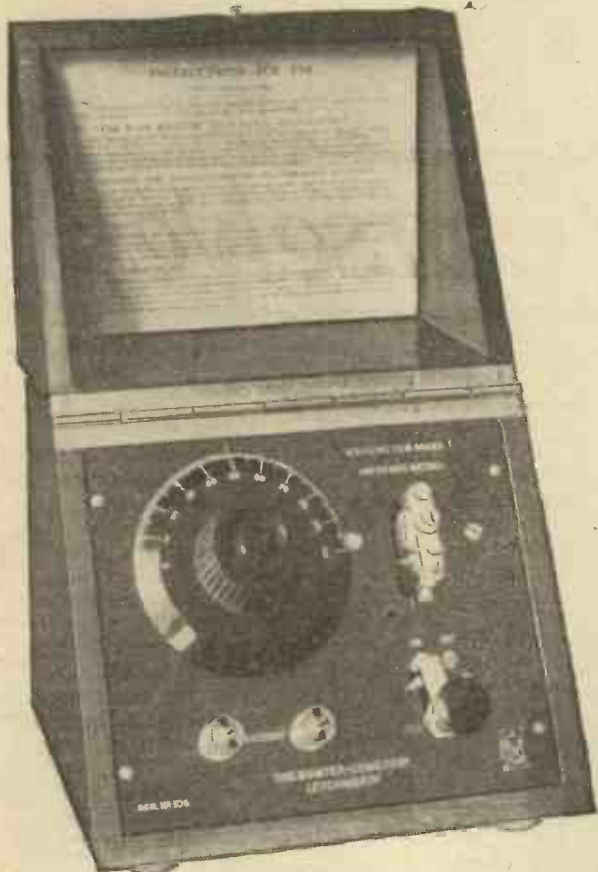

The Bowyer-Lowe Wave-meter.

lid, thereby depriving the instrument in practice of its protection from dust.

A Vario-Coupler.

From Messrs. the Bowyer-Lowe Co., Ltd., comes a vario-coupler of the type that has an ebonite tube rotor, and a tubular stator with fine and coarse tappings. The wavelength range on an aerial approximating to the P.M.G. standard proved, on trial, to be about 320 to 650 metres, used as a loose-coupler with tapped primary; and secondary tuned by a variable condenser of .0003 μ F maximum—larger values proved unnecessary—as a tapped primary inductance with variable reaction steady oscillations were obtainable from about 360 metres up, with R valve and 60 volts on the plate. As an inductively coupled crystal-receiver, over the range indicated the signal strength obtained was very good indeed; best with extremely loose coupling, when on local

broadcasting the reception was at "phones-on-table" strength with a moderate suburban aerial and good perikon crystal. The selectivity was naturally excellent with the loose coupling obtainable. The eight fine and eight coarse tappings of the primary coil enabled quite fine tuning to be effected.

The instrument is adapted for panel mounting, a convenient device for fixing in position behind the panel being provided. The general finish and mechanical design are excellent; the contact to the moving rotor firm and reliable; while the handsome bevel scale and large fluted knob fitted would grace any set. We are glad to notice the waterproofing of the insulation on the windings.

In all this is an extremely practicable and efficient coupler, for which many uses present themselves in wireless circuits.

A Double Variable Condenser.

The Marconi Scientific Instrument Co., Ltd., have submitted for examination a new double variable condenser, in which two distinct variable condensers, each of .00025 μ F capacity, are mounted on the same shaft and operated simultaneously and exactly proportionally by the same knob. The moving plates are connected to a common terminal; the two distinct sets of fixed plates being connected to two other terminals. Thus the instrument provides actually three different ranges of variable capacity: .00025 maximum with either of the two separate, variable simultaneously; .0005 with the two parts in parallel; and .000125 with the two in series.

The finish and workmanship of the instrument are what one would expect in the products of this firm. The condenser is built up of heavy brass, the plates being soldered in place; the construction neat and rigid, while the contact to the moving portion is positive. Substantial positive end-stops are provided, and the scale is particularly clear and easy to read.

In addition to its special purpose for use in two tuned anode circuits for simultaneous tuning, the condenser provides an extremely useful general experimental unit of elastic range.

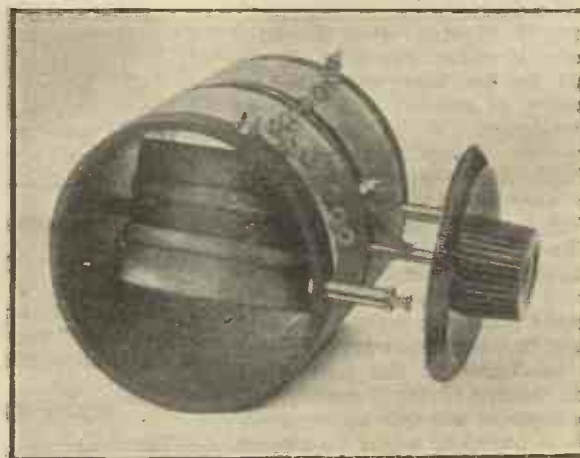

The Bowyer-Lowe Vario-Coupler.



Information Department

Conducted by J. H. T. ROBERTS, D.Sc., F.Inst.P., assisted by A. L. M. DOUGLAS.

In this section we will deal with all queries regarding anything which appears in "Modern Wireless," "Wireless Weekly," or Radio Press Books. Not more than three questions will be answered at once. Queries, accompanied by the Coupon from the current issue, must be enclosed in an envelope marked "Query," and addressed to the Editor. Replies will be sent by post if stamped addressed envelope is enclosed.

R. W. (Middlesbrough) sends details of his apparatus, and asks our advice, as it is not giving the results he expected it would.

We suggest you wire your transformer IP to plate OP to H.T. positive, IS to L.T. negative and OS to the grid of the next valve. We do not see why your circuit should not give very satisfactory results. Perhaps you will let us have further details.

D. K. (Sunderland) sends us a diagram of his circuit, and asks for advice.

If you will let us have full details of the apparatus you describe, we shall be better able to advise you. Your connections appear correct.

B. P. (Pontypridd) submits dimensions of variometers he has, and asks whether they would be suitable for a set he is about to erect. He also asks which is the positive and negative side of batteries in his circuit diagram.

The variometers you mention are very suitable. The positive side of the battery is denoted by a long thin line and the negative side by a short fat one. You should therefore have no difficulty in distinguishing which side of the battery is which.

G. M. (Sunderland) asks questions about various commercial types of telephones, and also wishes to know the name of a book which will show him how to add a low-frequency amplifier to his crystal receiver.

We are obviously unable to recommend the products of any particular manufacturer in these columns. You should test different types of telephones before purchasing them. A circuit for adding a low-frequency valve to a crystal receiver is given in "Practical Wireless Valve Circuits," Radio Press,

Limited, which will provide you with all the necessary information. The price of this book is 2s. 6d.

A. F. (Tolmont) wishes for particulars of a suitable crystal set to receive broadcasting from 5SC.

"The Construction of Crystal Receivers for Broadcast and General Reception," Radio Press, Limited, which will be ready in a week or two, will supply you with full particulars.

J. C. F. D. (Radlett) has a certain commercial pattern of receiver, with which he is not satisfied. He wishes to alter it to conform to circuit ST 34, and asks questions.

(1) The projected arrangement of wiring is quite suitable.

(2) The inductances L_2 and L_3 might be wound on cardboard cylinders as you suggest.

(3) The variable condenser C_2 might have a value of 0.0003 μ F and coils L_2 and L_3 should be wound with 50 turns of No. 24 S.W.G. enamelled wire. This will cover the British broadcasting band of wavelengths.

A. J. (Liverpool) asks for a diagram of a circuit using a two-coil holder, etc., together with the necessary values of condensers in this circuit.

Without further particulars of what range you wish to cover and what apparatus you propose to employ, we cannot give you a suitable circuit. The variometer you mention is a very good instrument, and most efficient on broadcasting wavelengths, which we presume concern you chiefly.

C. B. (West Merton) asks whether tubes 3 in. and 3½ in. diameter respectively could be used in the variometer set described in No. 1 of "Modern Wireless," in place of the tubes specified there.

The 3 in. by 3½ in. tubes will be quite suitable, and we suggest winding five more turns on each winding to compensate for the decrease in diameter.

A. B. C. (South Woodford) submits a circuit diagram of his apparatus and asks: (1) Whether the circuit is correct. (2) What windings there should be on the vario-coupler to cover from 150 to 600 metres.

(1) The circuit is correct except for the fact that the grid leak is on the wrong side of the grid condenser. The leak might be connected directly across the condenser if desired.

(2) It is not quite clear from your letter whether you mean a variometer or a vario-coupler to cover the range you mention. A range of from 150 to 600 metres is rather extensive without introducing variable condensers into the circuit, and we suggest you limit it to 250 to 600 metres, when any standard pattern of variometer advertised in this journal would be suitable.

A. V. P. (Ilford) refers to the circuit diagram on page 278 of "Modern Wireless," No. 4, and asks the values of the different components for broadcasting.

Condenser C_1 might have a value of $0.0015 \mu F$, and coil L_1 75 turns of No. 24 S.W.G. enamelled wire on a 3½ in. tube. Coil L_2 might have the same number of turns, and coil L_3 between 75 and 100 turns. Condenser C_2 should be not bigger than $0.0003 \mu F$, and condenser C_3 might be the same size. Resistance R_3 should be about 2 megohms, and the condenser C_4 $0.002 \mu F$. The telephones should be of high resistance, that is, greater than 1,000 ohms, and the resistances R_1 and R_2 might be 6 ohms. The valves should both be hard. The high tension battery might have a value of from 60 to 100 volts, and the battery B_1 6 volts. This circuit is very suitable for broadcast reception, and with a low-frequency valve would easily work a loud-speaker at the above address. This circuit is suitable for experimental work, and complies with the P.M.G.'s regulations regarding reaction.

J. F. M. (Beckenham) asks how a ¼ in. thick brass clip may be bent to a right angle without cracking, and also certain questions about making drills.

If the brass is heated to a dull red heat and bent while hot, there will be no danger of cracking. With regard to your second question we do not think there would be any economy in making drills by the method you suggest.

E. A. (Bristol) asks with reference to the diagram on page 215 of "Modern Wireless," No. 3, (1) A question regarding the valve panel. (2) What gauge and type of wire should be used for the aerial. (3) What sort of wire should be used for connecting the apparatus together.

(1) The connection to the first valve panel should be the same as those on the second valve panel. We regret that an error has appeared in this diagram.

(2) Stranded enamelled copper wire should be used for the aerial, which should be of as generous a cross-section as possible.

(3) Well insulated flexible wire may be used for connecting up the apparatus; the leads should not be longer than necessary.

H. J. E. (Birmingham) wishes to know how to construct a c.w. receiver for wavelengths of from 300 to 20,000 metres. He also asks whether a crystal circuit could be used with a buzzer to interrupt the continuous waves.

It is obviously impossible for us to design a complete valve receiver to cover this range in these columns. If you read "Modern Wireless" and "Wireless Weekly," you will have no difficulty in finding suitable apparatus for your purpose. A buzzer might be used to interrupt the continuous waves, but it generally causes a great deal of trouble and a valve set is much more efficient.

D. L. A. (Ellesmere) proposes to try to renew his burnt out valves. He asks whether we can help him in this matter.

It is not at all a practicable proposition for a private individual to attempt the renewal of valve filaments. Even if you succeeded in attaching the filaments satisfactorily, the process of exhausting the bulb in the correct manner calls for special apparatus, much of which is very complicated. It appears to us that the tungsten wire you mention would consume much more current than it ought.

F. H. B. (Kendal) asks (1) What relation exists between a coil used for high-frequency amplification on the anode reactance principle, and a secondary circuit coil. (2) For data for a proposed transformer.

(1) If the coils are both tuned with the same type of condenser, they may both have similar characteristics.

(2) You cannot make a transformer to transform down direct current.

A. F. (Finchley) is using a Dutch valve as a high-frequency amplifier with a crystal set, but complains of a buzzing noise. He asks what it is and how it can be prevented.

This sound is probably due to an alternating current supply laid on either in your house or near by. Without a diagram of your circuit we are unable to advise you on the other points you raise.

E. H. B. F. (Soothill) asks a question about a low-frequency interval transformer described in the "Construction of Wireless Receiving Apparatus," Radio Press, Limited.

This transformer is quite suitable for your purposes.

T. O. (County Durham) has built a two-valve note magnifier and experiences trouble with it.

You should shunt the telephone terminals with a fixed condenser having a value of not less than $0.002 \mu F$. This should stop the noise you complain of, which may however be due to working the valves at too high a filament temperature.

Absolutely Indispensable

MARCONI VALVES

MADE AT THE OSRAM LAMP WORKS

Where you require to obtain the best possible reception of vocal and musical items you must of necessity use **MARCONI VALVES**

They are the outcome of prolonged research and manufacturing experience by the world's leading experts, and have achieved a reputation for reliability under all conditions.

Made to Last

Sold by leading Electrical Contractors, Wireless Dealers and Stores.

The same Valves that were indispensable to our fighting services for wireless communication during the War are now indispensable to you.

They are used in the World's leading Wireless Transmitting Stations where the selection of a valve is the result of the most exhaustive tests.

(Wholesale only) :—

The General Electric Co. Ltd.
Head Office: Magnet House,
Kingsway, London, W.C.2.

Branches throughout the United Kingdom and in all the principal markets of the World.

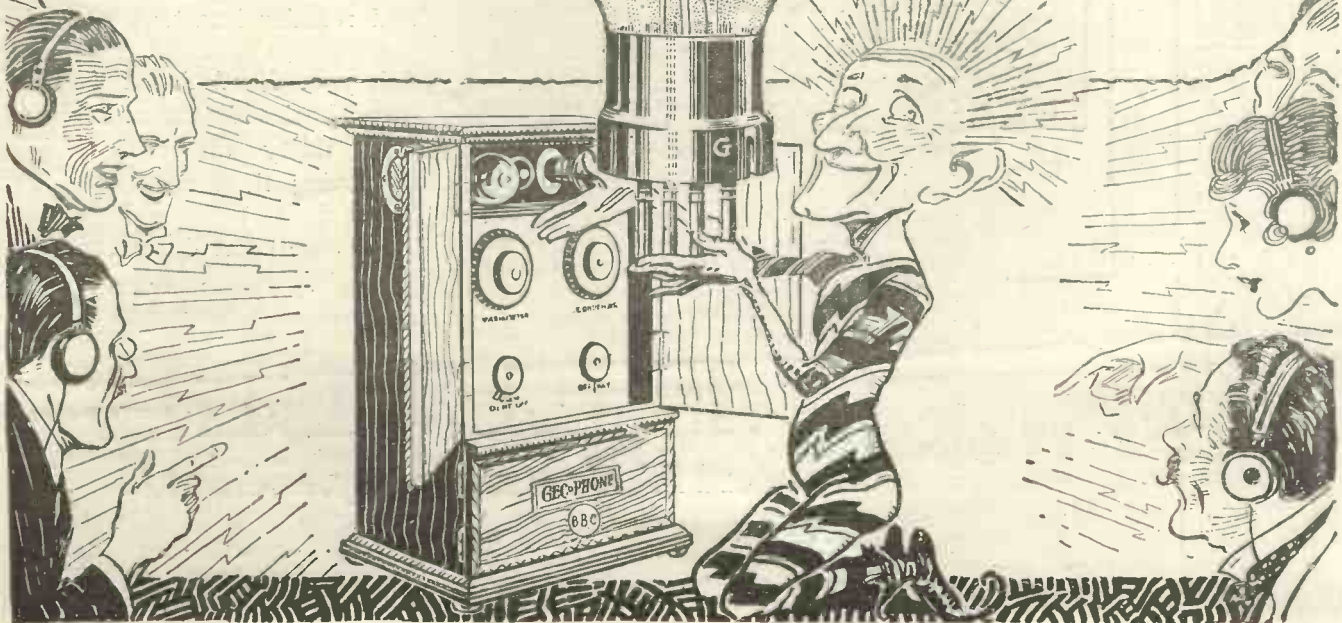
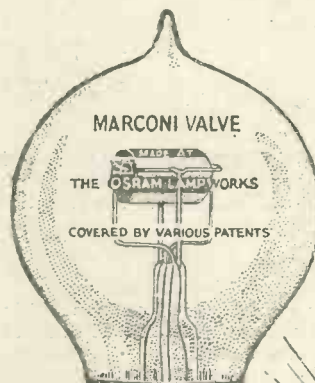

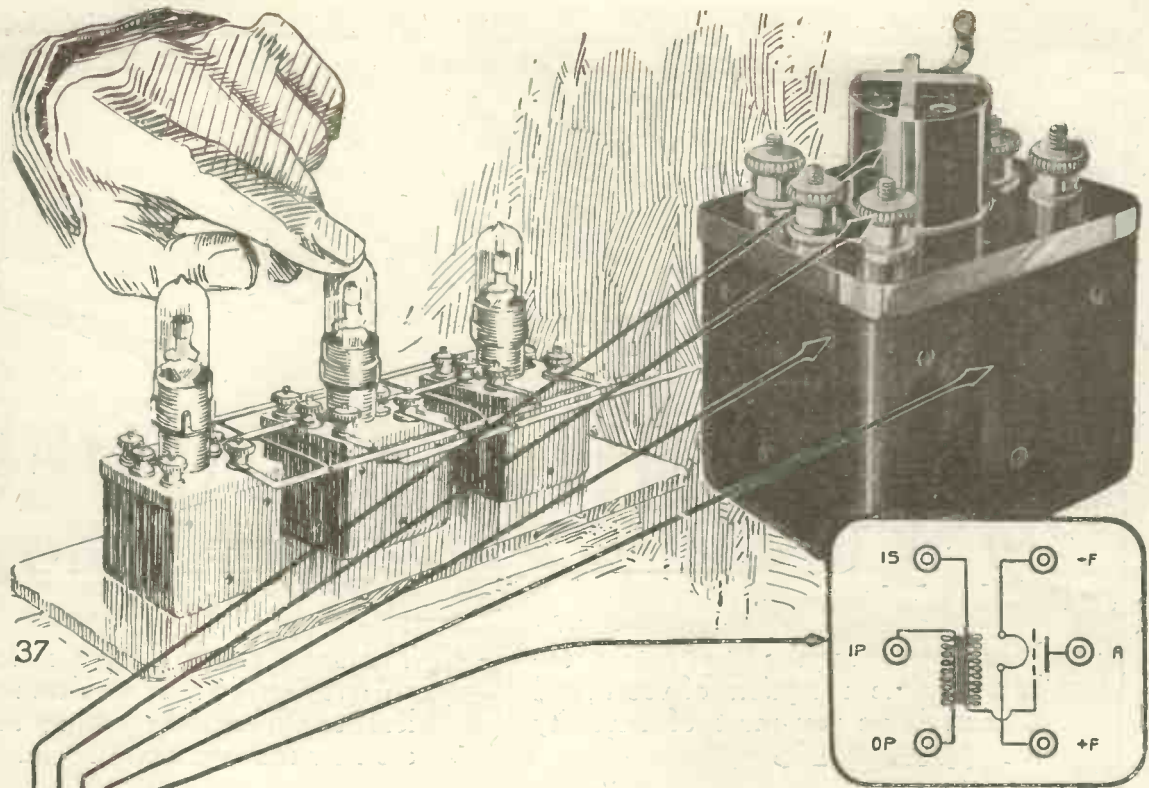

THE ELWELL AMPLIFYING AND DETECTOR UNITS.

Showing the internal connections of the Low-Frequency Amplifying units. Terminals clearly marked.

The case of the Low-Frequency unit is of iron. This allows a number of such units to be placed close together without fear of the complete set howling.

Tapped holes are drilled in two sides and in the base. This enables the unit to be fixed to the panel or to a base-board.

Units similar in appearance to this one, but for High-Frequency Amplification or for Rectifying are obtainable. Receivers of from one to seven valves can easily be constructed using these units.

The valve holder has specially long "leakage paths," also a clip for earthing the base of the valve. These combine to prevent noises in the phones.

These patented amplifying units, carefully designed and made of the highest grade materials, form ideal instruments, whether you are building your own set or whether you wish to add to your existing set.

THE ELWELL UNITS SAVE ALL THE EXPENSE of buying separate valve-holders, transformers, grid-Condensers, leaks and numerous terminals.

Each UNIT employs the most suitable component parts permanently connected in a compact case, and guaranteed while the seal remains intact.

Ask your Local Agent for the Elwell book of diagrams. It shows over thirty different circuits employing these units.

There are eight different types of unit. Prices from 19/6.

C.F. ELWELL^{LD}
 Craven House, Kingsway, London W.C.2.

Telephone : Regent 1607.
 Telegrams :
 "Elradioeng, Westcent, London."



Cables : Elradioeng,
 London,
 Western Union Code.

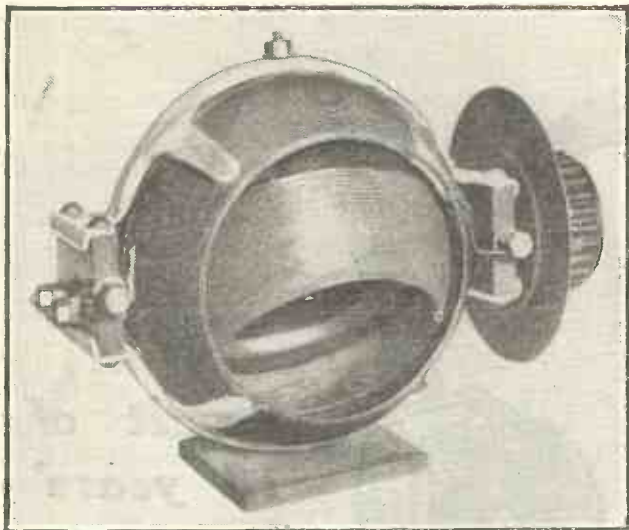

SOME EXAMPLES OF

G.R.C.

SUPERIORITY.

G.R.C. 71.
VARIOMETER
 (Prov. Patent 409/23)
PRICE 22/6

In the G.R.C. Variometer we have designed a most efficient instrument for exceptionally clear and accurate tuning. The stator coils are shielded by aluminium cages which may be earthed. Shielding the radio instruments is fast becoming recognised as the best way to build a highly efficient wireless receiver. Radio waves are so sensitive that even the slightest influence will disrupt proper signal reception.

As the stator coils are supported by the pressed aluminium cages there is no possibility of warping, therefore clearance between stator and rotor coils is reduced to 1/16th of an inch. This permits finer adjustment and avoids losses. A separate terminal is provided so that both cages may be earthed. Receiving sets equipped with these inductances not affected by body capacity. G. R. C. (patented) mercury contacts are used on these instruments, which ensures absolutely positive connection without scratching or noise, and nothing to wear out or break.

Distributed capacity is effectively minimised by a new method of winding both stator and rotor. No former block or bobbin is used. The coils are wound through an insulating solution which becomes glass-hard and secures them rigidly to shape.

This instrument is exactly as used in our standard receiving sets, and is guaranteed perfect. It is fitted with graduated, plated anti-capacity dial and G.R.C. standard fluted knob.

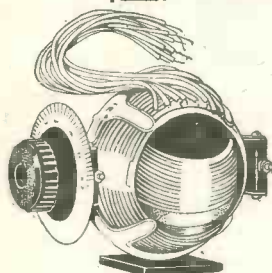

G.R.C. 72.
VARIO COUPLER.
 (Prov. Pat. 409/23)

PRICE - - 25/-

Of the same mechanical design as G.R.C. 71 Variometer, G.R.C. 72 Vario-Coupler is tapped in units and tens, and has a primary and secondary coupling of correct inductance values.

The use of a G.R.C. 72 Vario-Coupler in conjunction with a G.R.C. grid and plate Variometer will make a tuner of fine selectivity and great range.



This audio frequency transformer is the same as used on standard G.R.C. Audio Amplifiers, and was designed to permit maximum amplification with minimum distortion.

The "Audioformer" will function efficiently with all standard valves. Due to correct impedance ratio, minimising distributed capacity, low core losses, correct shielding and careful impregnation, as many as four stages of Amplification may be used without "howling." Each transformer is subjected to various severe tests during process of manufacture. The insulation is most complete and the "Audioformer" will function efficiently without danger of burning out in power amplifiers where a high potential is used.

G.R.C. 83.
SHIELDED L.F. TRANSFORMER.
PRICE - - 22/6

G.R.C. 83 "Audioformer" is a "Hedgehog" transformer with best grade silicon steel wire core, each core wire being treated with special core plate varnish. It is mounted in a plated case which may be earthed for shielding.

A postcard brings our free book—"A Radiophone in every Home." Write for it

NOW.

The articles illustrated are but some examples from the complete G.R.C. line. Before buying any receiving set or component compare it with a G.R.C. product.

GENERAL RADIO COMPANY

TWYFORD ABBEY WORKS, ACTON LANE, HARLESDEN, N.W. 10.

Telephone: Willesden 3055 (3 lines).

SHOWROOMS: 105, Great Portland Street, W.1.

Telegrams: "Milliamp, Phone, London."

BRANCHES in all cities.

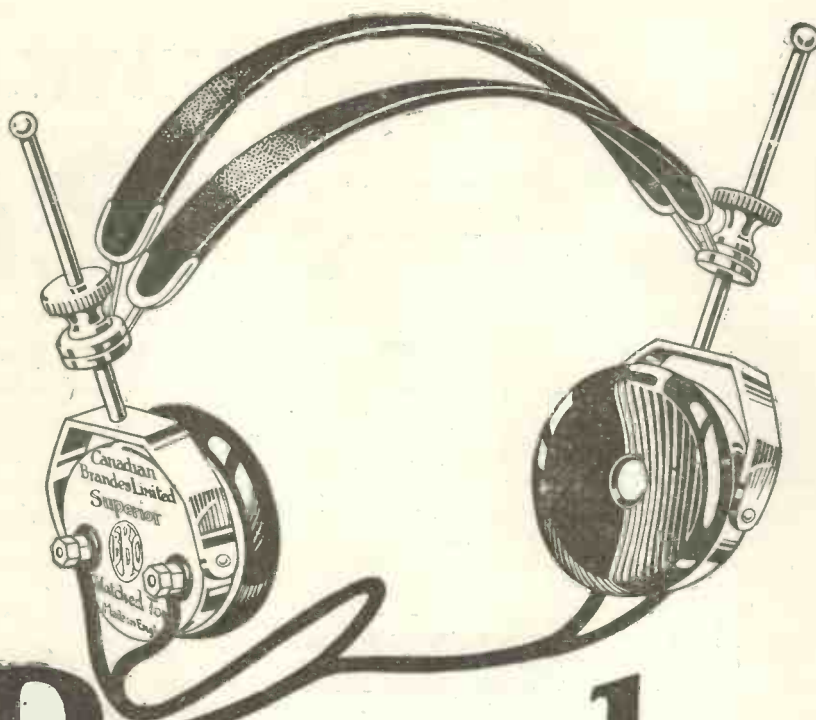

*Result of
15 years'
Experience*

Brandes

*"Matched Tone"
is an exclusive
Brandes Feature*

It means that the receivers are perfect "scund mates" tuned to give exactly the same pitch and volume of sound in both ears. The annoyance of blurring is banished for ever and every tone is clear, distinct and natural to a degree otherwise impossible. That is why you will find keen Radioists everywhere are adopting this Headset. *Every good Dealer sells and recommends Brandes "Matched Tone" Radio Headset.*

PRICE 32/-

Made in England and bears B.B.C. stamp.

CANADIAN BRANDES LTD.,

Walmer House, 296, Regent St., W. 1.

Telephone: Langham 1525.

Trade Enquiries Invited.

Matched Tone

TRADE MARK

Radio Headsets



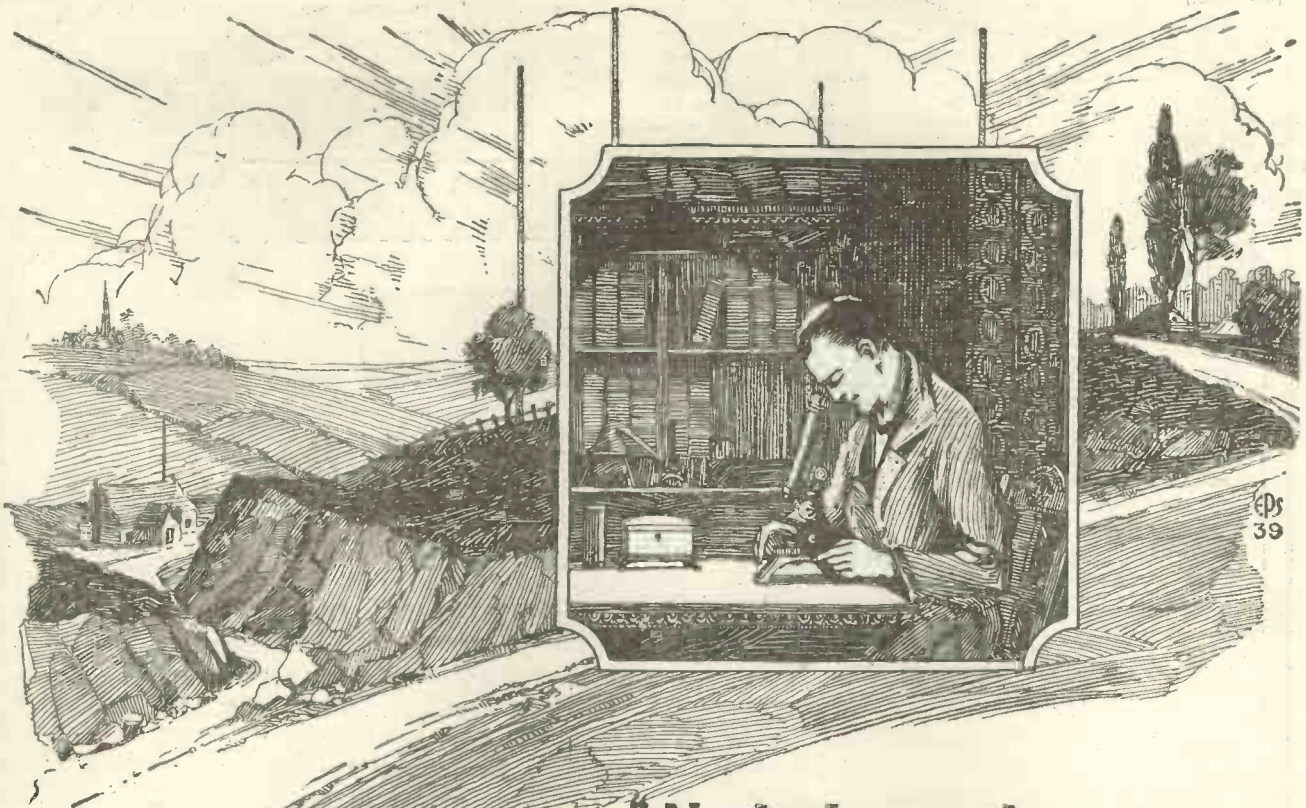

PS 39

**"Numberless as the gay notes
that people the sunbeams"**

THE power of the microscope discloses the wonders of the infinitely small.

The power of the valve produces enchanting music from the myriads of negligible currents that flock through space.

Choose your valve with the same care as you would a microscope.



**MULLARD
SUPERIOR
WIRELESS
VALVES**

THAT MEANS A

MULLARD.

Obtainable from all high-class electricians, wireless dealers, etc. If you have any difficulty write for address of nearest retailer.

*Advt. of the Mullard Radio Valve Co., Ltd.,
London, S.W.12.*



Entertain the Kiddies
with a

GECOPHONE

Britain's Best Broadcasting Set!

AS a source of real entertainment for the children, and a means of sending them happily to bed, "listening-in" on a GECOPHONE is unrivalled.

Every evening before bedtime an appropriate and most pleasing programme, including Fairy Tales, Nursery Rhymes, Vocal and Instrumental Music, is broadcasted, every word and sound of which will come to the little ones with a clearness and fidelity that will gladden their hearts.

The GECOPHONE—the supreme achievement in Wireless Broadcasting—is all that can be desired in efficiency, design, and finish, and represents the accumulative knowledge and experience of its manufacturers—The General Electric Co., Ltd.—in many years' Telephone and Wireless development.

Among the thousands of unsolicited letters of testimony is one from a Derbyshire user, who says: "We were able to get the opera at Covent Garden Theatre with your Two-Valve GECOPHONE. It was excellent, and all the instruments in the orchestra could be plainly heard. Also the applause. We were, so to speak, actually at the opera, and not striving to hear something a long distance away."

GECOPHONE CRYSTAL SET No. 1.

Complete with one set double head-phones and aerial equipment. Approx. range 25 miles. Price complete £5 10 0

GECOPHONE CRYSTAL SET No. 2.

Complete with one set double head-phones and aerial equipment. Approx. range 30 miles. Price complete £9 15 0

GECOPHONE 2-VALVE SET.

A mahogany set complete with valves, all batteries and one set double head-phones. Approx. range 100 miles. Price complete £25 0 0

GECOPHONE

"LISTENING-IN" SETS.

*Fully approved by H.M. Postmaster-General.
Comply in all respects with Broadcasting Regulations.*

**SOLD BY PRINCIPAL ELECTRICIANS,
STORES, MUSICAL and WIRELESS
DEALERS.**

*Sole Selling Agents for the Music Trades in Great
Britain and Ireland: Columbia Graphophone Co.,
Ltd., 102-108, Clerkenwell Road, London, E.C.1.*

(Manufacturers and Wholesale only)

**THE GENERAL ELECTRIC CO., LTD.,
Head Office - - Magnet House, Kingsway,
London, W.C.2.**

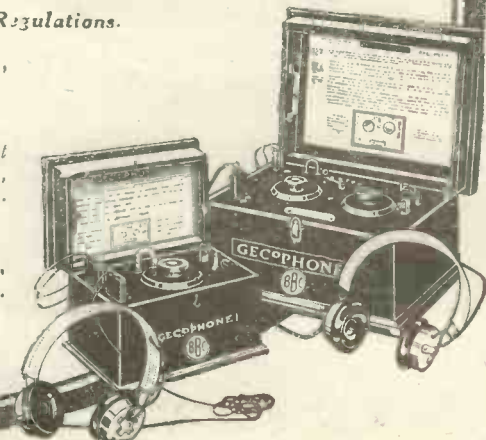
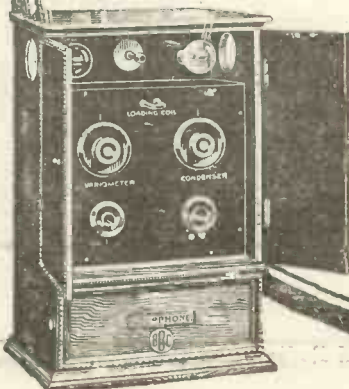



6^d

Buy it for your Wireless friend

Before attempting to explain to your friend interested in Wireless how a Receiving Set works, get him a copy of this excellent little Handbook.

When he has read it he will have a good elementary idea of the principles of Wireless. It will save you time and your friend will appreciate your assistance.

From all Book-sellers and News-agents, or 7d. post free direct from Publishers.

Wireless for All

RADIO PRESS
Wireless Library
No. 1.

By John Scott-Taggart, F.Inst.P.
(Editor of Wireless Weekly)

Contents

Morse Code—How to Tell what Station is Working—How Wireless Signals are actually sent—Meaning of Wave-length—How Wireless Waves are Set up and Detected—How Wireless Stations work at the same time without interfering with each other—Waves from a Wireless Telephone Station—How a Wireless Receiver Detects Waves—The Aerial—The Earth Connection—How a Wireless Set is Tuned to a Certain Wave-length—The Variable Condenser—The Crystal Detector—How a Valve Works.

6d.

RADIO PRESS, LTD.,
Devereux Court,
STRAND,
W.C.2.



Listen in with the Fellows

Handphone which has been specially designed for ladies. It has no head band to catch or tear the hair. Beautifully finished, very comfortable to use.

HANDPHONE - - - - - 15/3 each
Inclusive of all taxes. Postage 1/

He will use Fellows Headphones with two ear-pieces in light die cast non-ringing metal and wound to 4,000 ohms.

HEADPHONE - - - - - 21/6 per pair.
Inclusive of all taxes. Postage 1/

All Fellows radio instruments are British Made throughout and guaranteed.

FELLOWS MAGNETO Co., Ltd.
LONDON, N.W.10.

Telephone: WILLESDEN 1560-1.

Telegram: "QUICKMAG," IPHONE, LONDON.



For they are jolly good Fellows

wireless - without an aerial

The "Ducon" does away with the Aerial. Plug one into an ordinary electric lampholder or wall-socket, connect to your wireless receiver, and you will receive the broadcasting perfectly.

The "Ducon" can be used with complete safety—each one is tested to 2,500 volts; *it consumes no current* and does not affect the electric light in any way.

The DUCON 10/-

is obtainable from leading wireless dealers, electrical contractors and stores, or direct from the makers.

Over 50,000 in Use.

Dealers not yet stocking are invited to write for trade terms.

The Dubilier Condenser Co. (1921) Ltd., Dept. D.

Ducon Works, Goldhawk Road, Shepherd's Bush, W.12.

Telephone: Hammersmith 1084.

Telegrams: Hwoltcon, Phone, London.



Components of Quality

AERIAL WIRE—Bare, 100' ..	3/3	CONDENSERS, Polar, .001 ..	14/3	INTERVALVE TRANSFORMERS	14/-
150' ..	4/9	CONDENSER VANES, special slip-in type .. pair ..	2d.	SYSTOFLEX TUBING per yd. ..	5d.
BRASS LAMINATED SWITCH ARMS (laminations simil r to W.D. Type) ..	2/9	CONTACT STUDS with nuts and washers .. per doz. ..	11d.	TERMINALS, with 2 nuts, per doz. ..	2/6
COILS (Tingey Patent):		DEWAR SWITCHES, new, not ex-Government, 3-way ..	8/-	TELEPHONE TRANSFORMERS for 120 ohm 'phones, own make ..	12/-
A*, 150-450m. ..	£1	DEWAR SWITCHES (ex-Government), 3-way ..	4/-	VALVE LEGS, with nuts and washers .. per doz. ..	1/3
A, 300-2,000m. ..	£1 5/-	EBONITE, 1/4", cut to size lb. ..	4/-	VALVE HOLDERS, with flange, with washers and nuts ..	10d.
B, 1,000-8,500m. ..	£1 17/6	FILAMENT RESISTANCES on Erinoid Former ..	3/-	VALVE HOLDERS, fitted with 4 terminals, G.P.F. plus and minus ..	2/6
C, 5,000-24,000m. ..	£3 2/6	GRID LEAKS and Anode Resistances, any value, own make ..	2/-	WIRE, cotton and silk. All grades.	
CONDENSERS, for panel mounting:—		HEADPHONES—Brown's and Sterling's.			
.001 ..	10/6	INSULATORS, Reel ..	2d.		
.0005 ..	6/9	Egg ..	3d.		
.0002 ..	4/6	Shell ..	9d.		
.00005 ..	3/3	Keystone ..	6d.		
CONDENSERS, sets of parts:—					
.001 ..	9/-				
.0005 ..	5/6				
.0002 ..	3/6				
.00005 ..	2/3				

We manufacture Valve Sets—1, 2, 3, 4 and 5 Valves, also an excellent Crystal Set.

Send for our new Components LIST—free on request.

Offices and Showrooms: 92, QUEEN ST., HAMMERSMITH, LONDON, W.6.

'Grams: "Tingoidar, London"

'Phone: Hammersmith 1916.



DIRECTORY OF SUPPLIERS

"TO WIRELESS SUPPLIERS."—Half inch in column spaces for names and addresses and particulars of apparatus supplied in the districts of this Directory are offered at the rate of 10/- per insertion, or 12 insertions £5 5s. 0d. prepaid. Communications with remittance should be sent to Scheff Publicity Organisation, Ltd., 125, Pall Mall, London, S.W.1. Advertisers are included under one district without charge.

LONDON.

RADIO SOCIETY OF GREAT BRITAIN.

Hon. Sec.: 32, Quex Road, West Hampstead, N.W. 6.

SUPPLIERS:

American Hard Rubber Co. (Britain) Ltd., 13a, Fore Street, E.C. 2.

Autoveyors Ltd., 84, Victoria Street, S.W. 1.

British L.-M. Ericsson Manufacturing Co. Ltd., 63, International Buildings, Kingsway, W.C. 2.

Burndept, Ltd., 15, Bedford Street, Strand, W.C.2. Phone: Gerrard 7794.

Buss, T. O., 77, Clerkenwell Rd., E.C. 1.

City Accumulator Co., 79, Mark Lanc, E.C. 3.

The Dubilier Condenser Co. (1921) Ltd., Ducon Works, Goldhawk Rd., Hammer-smith, W. 12.

Economic Electric Ltd., 10, Fitzroy Square, W. 1.

Edison Swan Electric Co., Ltd., 123, Queen Victoria Street, E.C. 4.

C. F. Elwell, Ltd., Craven House, Kingsway, W.C. 2.

Fallon Condenser Co., 230A, Hermitage Road, N. 4.

Fellows Magneto Co., Ltd., Cumberland Avenue, N.W. 10.

Gambrell Brothers, Ltd., Merton Road, Southfields, S.W. 18.

General Radio Co., 105, Gt. Portland Street, W. 1.

General Electric Co., Ltd., Magnet House, Kingsway, W.C. 2.

Alfred Graham & Co., St. Andrew's Works, Crofton Park, S.E. 4.

S. Guiterman & Co., Ltd., 35, Alderman-bury, E.C.2.

BEST DUTCH VALVES, 7s. 6d. each. Apply for Trade terms. Harris-Russell, Ltd., 15, Great Chapel Street, Oxford Street, W. 1. Phone: Regent 1791.

Hestia Engineering Co., 32, Palmerston Road, W. 3.

LONDON—(continued).

Holborn Radio Co., Ltd., 267, High Holborn, W.C. 1.

Igranic Electric Co., Ltd., 147, Queen Victoria Street, E.C. 4.

Joanes, W., 42, Jenner Road, Stoke Newington, N. 16.

Leslie McMichael, Radio Corner, Strand, W.C. 2.

Marconi Wireless Telephone Co., Ltd., Marconi House, Strand, W.C. 2.

Mullard Radio Valve Co., Ltd., 45, Nightingale Lane, Balham, S.W. 12.

Negretti & Zambra, 38, Holborn Viaduct, E.C. 1.

New Simpolia Wireless Co., 172, West Green Road, Tottenham, N.15.

TOWNSEND WAVEMETERS. ex Disposal. A limited number carefully calibrated, in new condition. Price £4 15s. 0d. each. Omega Lampworks Ltd., 83 Merton Road, S.W.19.

Peto-Scott Co., Featherstone House, 6, High Holborn, W.C. 1.

Radio Communication Co., Ltd., 34-35, Norfolk Street, Strand, W.C. 2.

Radio Instruments Ltd., 12, Hyde Street, W.C. 1.

M. Raymond, 27, Lisle Street, W.C. 2.

Richford & Co., 153, Fleet Street, E.C. 4.

Rowley & Louis, 12, The Broadway, Muswell Hill, N.

Simpson & Blyth, 8, Sherwood Street, W. 1.

Sterling Telephone & Electric Co., 210, Tottenham Court Road, W. 1.

Tingey Wireless Ltd., 92, Queen Street, W. 6.

Waterloo Electric Co., 129, Waterloo Road, S.E. 1.

Western Electric Co., Ltd., Connaught House, Aldwych, W.C.

The Wilkinson Motor and Engineering Co., 10-14, and 29-33, Lonsdale Road, Kilburn, London, W.C. 10.

BELFAST.

SUPPLIERS:

The Electrical Installation & Repairing Co., 40, Berry St., Belfast. Phone: Belfast 3659.

BIRMINGHAM.

BIRMINGHAM EXPERIMENTAL WIRELESS CLUB.

Hon. Sec.: 110, Ivor Road, Sparkhill.

SUPPLIERS:

C. S. Baynton, 133, New Street, Birmingham. Agent for Burndept, Ltd.

Rogers, Foster & Howell, Ltd., Edward Road, Balsall Heath.

Wilkins & Wright, Ltd., Utility Works, Kenyon Street.

BLACKPOOL.

SUPPLIERS:

Saxon Radio Co., South Shore, Blackpool.

BRADFORD.

SUPPLIERS:

J. DYSON, 5 & 7, Godwin Street, Bradford. Complete Sets. All Accessories. Tele: 6037 & 6033. Telegrams: "Equipment."

BRIGHTON.

BRIGHTON AND HOVE RADIO SOCIETY.

Hon. Sec.: 68, Southdown Avenue, Brighton, Sussex.

SUPPLIERS:

H. J. Galliers, 32, St. James's Street, Brighton. Agent for Burndept, Ltd.

CARDIFF.

SUPPLIERS:

Messrs. Burndept, Ltd., 67, Queen Street, Cardiff.

COVENTRY.

SUPPLIERS:

M.L. Magneto Syndicate, Ltd., Victoria Works.

DORSET.

EAST DORSETSHIRE WIRELESS SOCIETY.

Hon. Sec.: "Hillmorton," Ringwood Road, Newtown, Parkstone.

SUPPLIERS:

E. T. Chapman, A.M.I.E.E., Wireless and Electrical Engineers, Ringwood Road, Newtown, Dorset. Agent for Burndept, Ltd.

EDINBURGH.

EDINBURGH AND DISTRICT RADIO SOCIETY.

Hon. Sec.: 9, Ettrick Road, Edinburgh.

SUPPLIERS:

EDINBURGH.
Spensers (Scotland), Ltd., 119, George St.,
Edinburgh. Agents for Burndept, Ltd.

William Sinclair, 60-64, Thistle Street. All
component parts in stock at lowest prices.

GLASGOW.

Clyde Electrical Co., Palm Street, N.W.

SUPPLIERS:

W. A. C. Smith, Ltd., 93, Holm Street,
Glasgow. Agent for Burndept, Ltd.

ROBERT BALLANTINE
St. Vincent St., Benfield St. Corner, Glasgow.
Sole Agent
Glasgow & District for L. McMichael, Ltd.,
London.

GUILDFORD.

Drummond Brothers, Guildford.

SUPPLIERS:

Selwyn Weston, Playhouse Arcade,
Guildford. Agent for Burndept, Ltd.

HALIFAX.

HALIFAX WIRELESS CLUB AND
RADIO SCIENTIFIC SOCIETY.

Hon. Sec.: Clare Hall, Halifax.

SUPPLIERS:

Electrical Supply Stores, 11, Fountain
Street, Halifax.

Electrical Supply Stores, King's Cross.

ILFORD.

ILFORD AND DISTRICT RADIO
SOCIETY.

Hon. Sec.: 77, Khedive Road, Forest
Gate.

LEEDS.

LEEDS AND DISTRICT AMATEUR
WIRELESS SOCIETY.

Hon. Sec.: 37, Mexborough Avenue,
Chapelton Road, Leeds.

LEEDS—(continued)

SUPPLIERS:

British Wireless Supply Co., Ltd., 6,
Blenheim Terrace.

Burndept, Ltd., London Assurance House,
Bond Place, Leeds.

LEICESTER.

LEICESTERSHIRE RADIO AND
SCIENTIFIC SOCIETY.

Hon. Sec.: 269, Mere Road, Leicester.

LIVERPOOL.

LIVERPOOL WIRELESS SOCIETY.
Hon. Sec.: 138, Belmont Road, Liverpool.

SUPPLIERS:

Ashley Wireless Telephone Co., Ltd., 69,
Renshaw Street, Liverpool.

W. C. Barraclough, 10, South John Street,
Liverpool. Agent for Burndept, Ltd.

MANCHESTER.

MANCHESTER RADIO SCIENTIFIC
SOCIETY.

Hon. Sec.: 16, Todd Street, Manchester.

SUPPLIERS:

A. Franks, Ltd., 95-97, Deansgate, 44,
Market Street, 73, Oxford Street,
12, Victoria Street, Manchester, and
90, Bradshawgate, Bolton.

Victoria Electrical (Manchester) Ltd., 1-5,
Chapel Street, Manchester.

Ward & Goldstone, Ltd., Frederick Road,
Pendleton.

W. C. Barraclough, North-west Depot
for Burndept, Ltd., 61, Bridge Street,
Manchester.

NEWCASTLE-ON-TYNE.

NEWCASTLE AND DISTRICT AMA-
TEUR WIRELESS ASSOCIATION.

Hon. Sec.: 51, Granger St., Newcastle-
on-Tyne.

SUPPLIERS:

Travers, Ltd., 73 & 77, Pilgrim Street.
Agents for Burndept Wireless Apparatus.

WALKERS' WIRELESS
Hold the largest variety of wireless apparatus
in the North. Send for particulars.
31, Westgate Road, Newcastle-on-Tyne.

NOTTINGHAM.

NOTTINGHAM AND DISTRICT
RADIO EX. ASSOCIATION.

Hon. Sec.: 99, Musters Road, W. Bridg-
ford, Nottingham.

SUPPLIERS:

Pearson Bros., 54, 55, 56, Long Row,
Nottingham. Agent for Burndept, Ltd.

OSWESTRY.

SUPPLIERS:



H.T. BATTERY.—Genuine, direct from maker, saving trade profits. Cash refunded if unsatisfied. 40 extra large dry cells, 3 times capacity of standard size, each has brass terminal, and replaceable. Cells paraffin waxed, in wood divisions, terminals on ebonite panel. Very quiet. In Polished Oak Cabinet, 12in. by 7½ in. by 4 in., weight 10 lbs., 60 volts, 22s. 6d. Spare cells, 3s. Sample cell, particulars, 6d. Been sold to trade at 32s. 6d. Once seen, no other type tolerated. Carriage extra. Maker, **FINCHETT, 1, Welsh Walls, Oswestry.**

POOLE.

EAST DORSETSHIRE WIRELESS
SOCIETY.

Hon. Sec.: Abbotsford, Serpentine Road,
Poole.

SUPPLIERS:

E. T. Chapman, A.M.I.E.E., Wireless and
Electrical Engineer, 38, Serpentine
Road, Poole. Agent for Burndept, Ltd.

PRESTON.

SUPPLIERS:

Geo. Wilkinson, Wireless Specialist, 152,
Church Street, Preston (opposite Miller
Arcade). General Supplies.

TORQUAY.

SUPPLIERS:

Sydney Truscott, 44, Fleet Street, Sole
Agent for Burndept Wireless Apparatus.

Western Counties' Electrical Engineer-
ing Co., Middle Bank Chambers,
Middle Street. Agents for Burndept
Wireless Apparatus.

TUNBRIDGE WELLS.

SUPPLIERS:

H. Featherstone, 22, London Road.
Agent for Burndept Wireless Apparatus.

YEOVIL

SUPPLIERS:

Messrs. Western Counties Electrical
Engineering Co., "Electricity House,"
Princes Street, Yeovil. Agent for Burn-
dept Wireless Apparatus.

A PERFECT RECEPTION

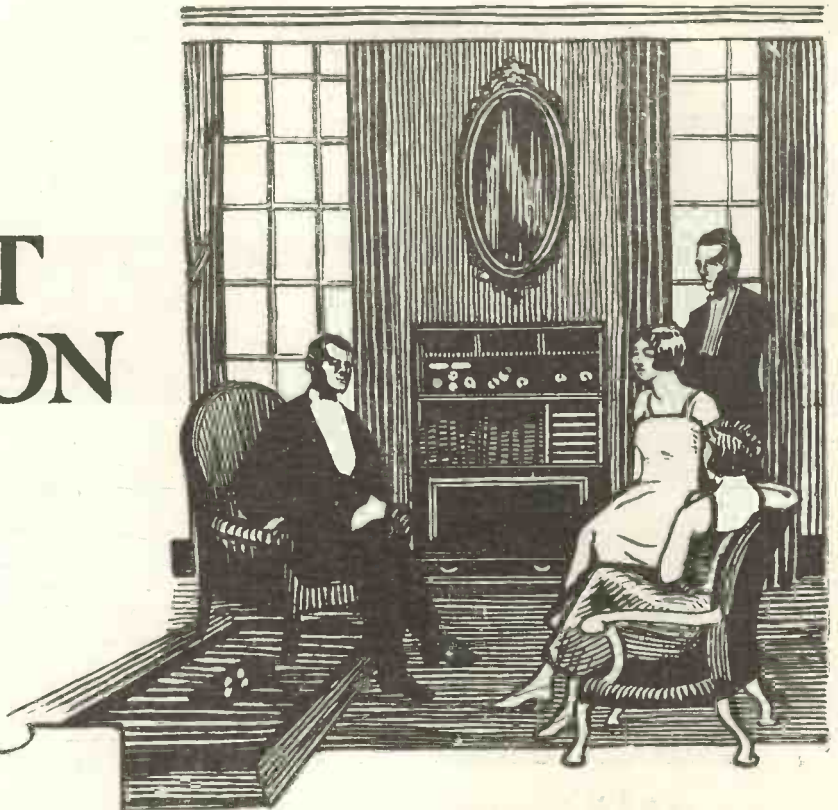

7 valve Polar B Radiophone Oak Cabinet,
£90.

In mahogany, £93.

'POLAR' "LATE 1923" MODELS

The way they receive—and the way they are received by the wireless world—both are the direct outcome of the faultless performance of these late 1923 POLAR RADIOPHONES.

Perfection is preserved by total absence of interference—truthful rendering of voice and instrument being received equally well at long range by 'phones or loud speaker—and this from any individual Broadcasting Station you care to select, without the interference of other programmes

The simplicity of operation is demonstrated by the special "Polar" service engineer, who will attend by appointment your first evening concert after installation.

Particulars from your local agent—or direct—

RADIO COMMUNICATION CO., LTD.

34-35, Norfolk Street, London, W.C. 2

BRANCHES:—

Newcastle, 17, Sandhill; Southampton, 19, Queen's Terrace; Cardiff, Atlas Chambers, James Street; Liverpool, 67, Dale Street; Glasgow, 125, Hope Street; Warrington, 37, Bridge Street; Aberdeen, 9, Hadden Street.

Telephones, Central 8480

(3 lines).

Telegrams: "Radiocomco-
Estrand," London.



Where you see the Polar sign you can buy Polar accessories

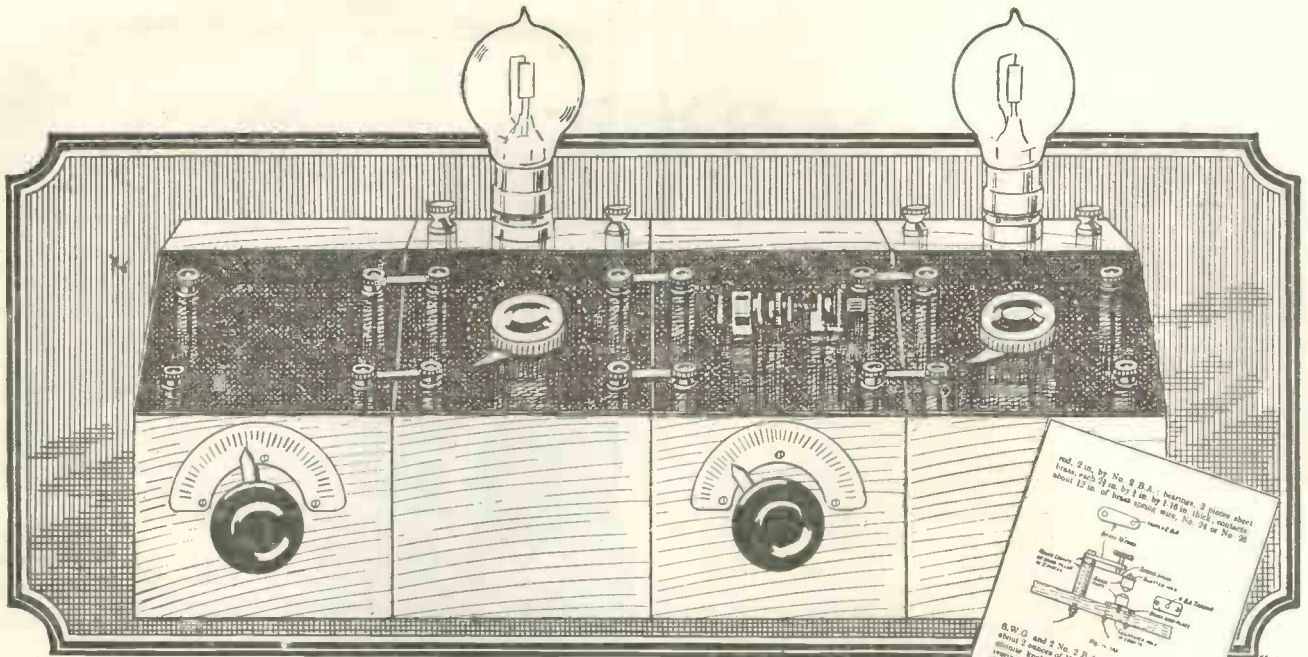

Such clear instructions enable anyone to build this excellent 4-Unit Set

ONE special feature of this new Book is that it does not presume any knowledge of Wireless at all on the part of the purchaser.

Constructional articles in "WIRELESS WEEKLY" and "MODERN WIRELESS" necessarily anticipate that the reader has some knowledge of Wireless—if only of the most elementary kind.

Even if you don't know one end of the Receiving Set from the other, and have never even "listened in," you can buy this Book confident that you can build your own Set—one which will give you particularly good results over long distances.

The Receiving Set described in this Book is quite different to any yet placed on the market. It is particularly neat and efficient, and as an economical Set it is certainly without parallel. For, at an original outlay of a few shillings, it is possible to construct the Detector Unit (which uses a crystal) and to enjoy the pleasures of "listening in" right from the very beginning. Later on—and at your convenience—you can add valves which will enable you to pick up Broadcasting stations further away, or to use a Loud Speaker instead of head-phones.

The whole Instrument has been carefully designed and tested for reception over long distances.

Get a copy Now—and start Wireless economically.

Radio Press Ltd., Devereux Court, Strand, W.C.2

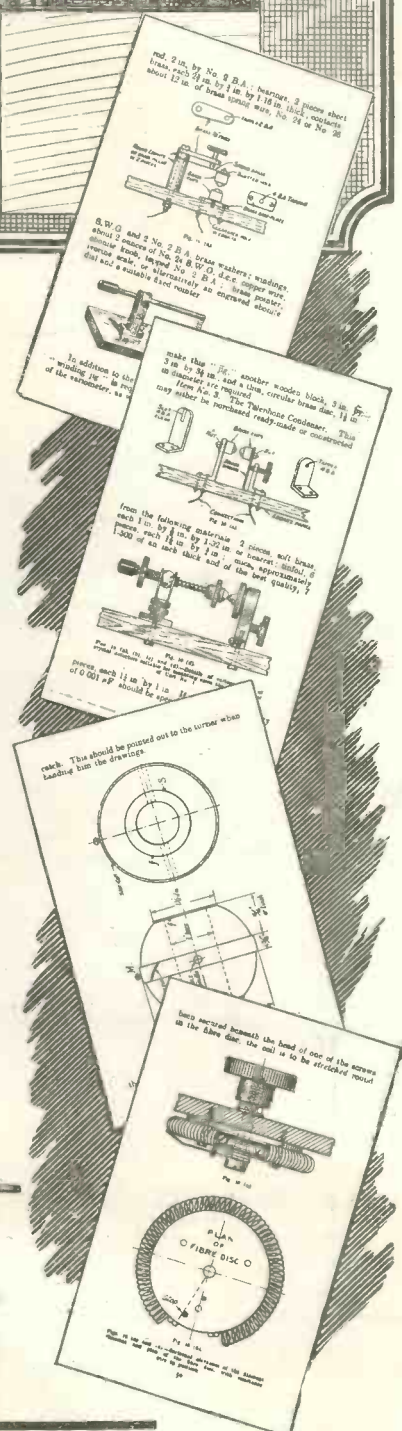

How to make a "Unit" Wireless Receiver

By E. REDPATH (Assistant Editor of "Wireless Weekly.")

RADIO PRESS
Wireless Library
No. 7.

2/6

or 2/8 post free

AMPLION

The Amplion Pedigree

- In 1887.. Mr. Alfred Graham demonstrated the first practical Loud Speaker.
- In 1893.. GRAHAM Loud Speakers placed upon the market.
- In 1894.. First used in the British Navy. Transmitters applied to Phonographs for Loud Speaker reproduction. Demonstrations by Prof. McKendrick at the Royal Society.
- In 1896.. Naval Telephones developed and adopted by the Admiralty.
- In 1898.. Watertight Loud Speakers Patented. Fitted on board many warships and mercantile vessels. Telephonic Submarine Signalling System devised.
- In 1902.. Complete Loud Speaker installations on central battery plan erected on warships as sole means of communication.
- In 1906.. The most extensive naval installation to date, including exchange system fitted to H.M.S. Dreadnought.
- Onwards.. Graham Loud Speakers applied to all sorts and Conditions of service at home and abroad, ashore and afloat.
- To 1919.. No less than 12,000 ship installations carried out.
- In 1920.. "AMPLION" Loud Speakers produced for Wireless and "AMPLION" Trade Mark registered.
- In 1922.. "AMPLION" standardised by leading manufacturers of radio apparatus

—the Reason Why the "AMPLION" is undeniably the finest Radio Loud Speaker and recognised as the World's Standard. It will be seen that the "AMPLION" is not merely produced to meet a sudden demand, but is the result of years of experience in Loud Speaker design and construction.

ASK FOR FOLDER M. W.
ALFRED GRAHAM & CO.,
 St. Andrew's Works,
CROFTON PARK, LONDON, S.E.4.

'Phone : Sydenham 2820-1-2. Grams : "Navalbanda, Catgreen."
 SCOTLAND : London.
 Mr. F. M. Milligan, 25, Renfrew St., Glasgow
 IRELAND :
 Mr. A. R. Munday, 41, Chichester St., Belfast
 CANADA :
 Messrs. Burndept of Canada, Ltd., 172, King Street West, Toronto.

DEMONSTRATIONS at our Showroom:
THE ALGRAPHONE SALON,
 25/6, Savile Row, Regent St., London, W.1.
 'Phone : Regent 1075.

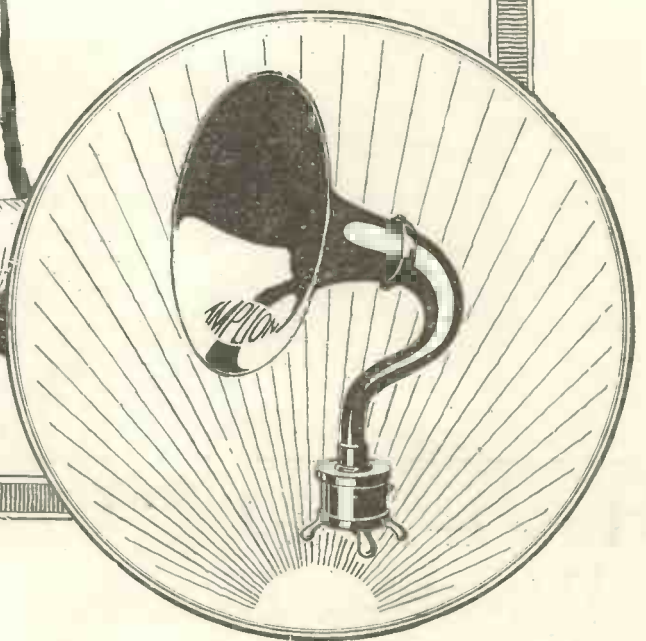

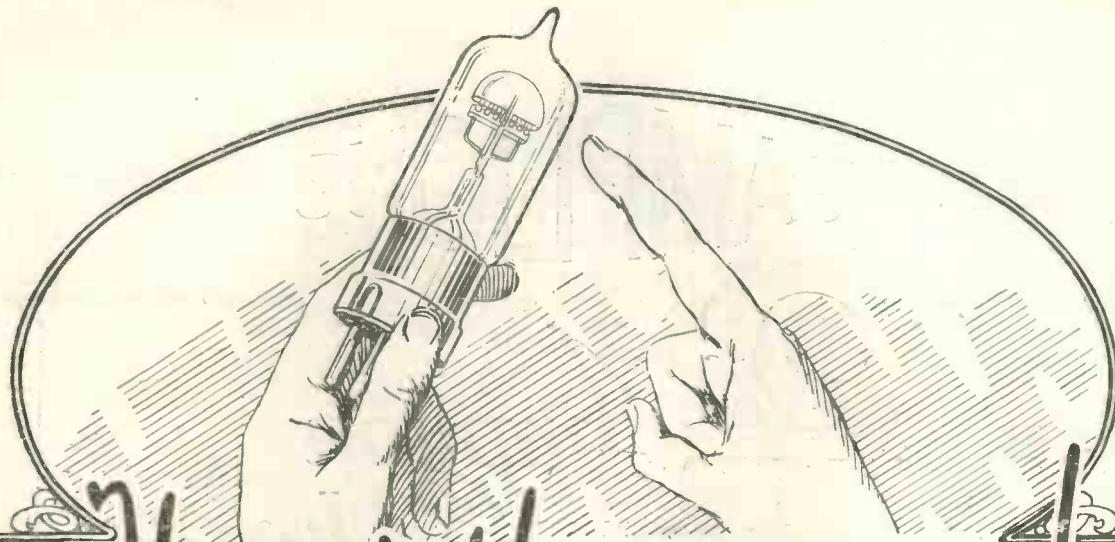

Here's the reason!

—the marked superiority of the *Cossor* Valve is due to its unique design.

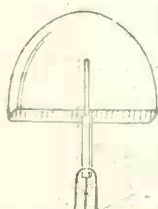

The Anode.

WHETHER rectifying or amplifying every Valve depends on a good flow of electrons between Filament, Grid and Anode. The fewer electrons that are wasted, the greater will be the efficiency of the Valve.

In the *Cossor* the curved filament is first surrounded by the hood-shaped Grid and the whole is then almost totally encircled by the Anode.

By this unique design, therefore, practically the whole of the electron stream is utilised and none can escape wastefully to the sides of the glass.

But besides this, the exceptionally strong Grid with its wires anchored in *three* places ensures long life with a remarkable freedom from distortion and microphonic noises.

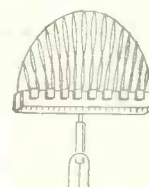

The Grid.

Already the *Cossor* has been singled out by experimenters as *the* Valve for difficult reception work. Why not benefit by their experience and let your next Valve be a *Cossor*?

Cossor

Sold by all dealers in Wireless components and manufactured by:
COSSOR VALVE CO., LTD.,
HIGHBURY GROVE, N.5.

Amplifies

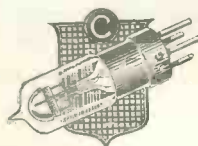

Rectifies

each
15/-

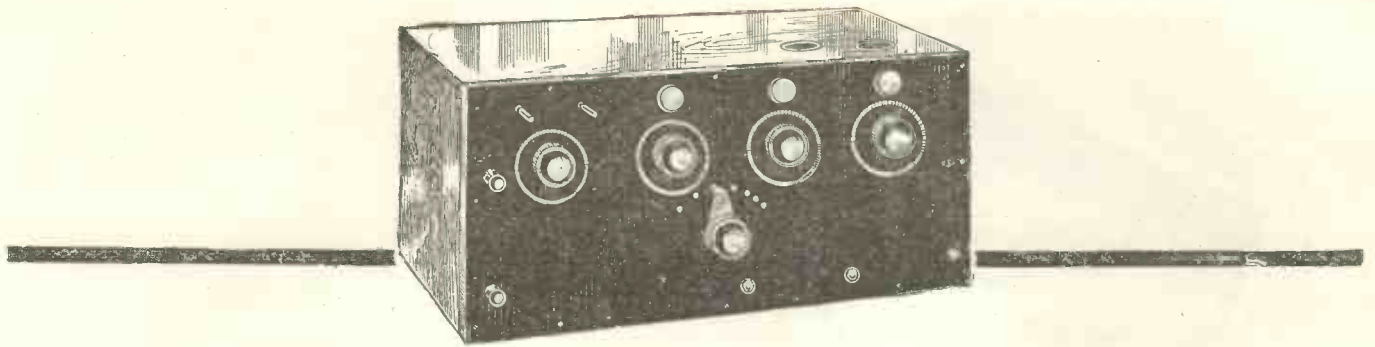

The Best Finish for Radio Cabinets

With Johnson's Wood Dye you can finish the cabinet of your Radio Outfit as well as an expert cabinet maker, and in any colour you wish, to harmonise with your other furniture. It comes in fifteen different beautiful shades, all of which can be lightened or darkened—full directions on every label. Johnson's Wood Dye is easy to apply. It penetrates deeply and brings out the beauty of the grain without raising it—it dries in four hours.

JOHNSON'S WOOD DYE

is used and recommended by most cabinet makers. They know that there is nothing that can equal it for a rich, everlasting finish.

JOHNSON'S POLISHING WAX

An occasional application of Johnson's Polishing Wax over the finish of Radio Cabinets, whether bought sets or home-made, will always keep them looking new, and gives a beautiful polish that will not collect dust or show finger prints. It will improve greatly the appearance of all cabinets.

Renovates Ebonite

Johnson's Prepared Wax is an ideal preparation for restoring ebonite panels and other instrument boards as used on wireless receiving sets. Furthermore, panels treated with Johnson's Prepared Wax resist acid fumes given off from the low-tension battery, and prevents that thick film of acid which you have no doubt noticed covering the whole of the ebonite panel, and causes a terrific leakage and bad results.

Give Johnson's Prepared Wax a trial. You will be surprised at the wonderful clean appearance it gives, and the better results you will get.

S. C. JOHNSON & SON, LTD.,

"The Wood Finishing Authorities."

WEST DRAYTON, MIDDLESEX.

FREE BOOK ON WOODFINISHING

To all who write for it, we will gladly send our illustrated book on the Proper Treatment of Woods. It explains how to obtain the best possible finish on all kinds of wood, and it will be a great help to all those who are making their own outfits.



S. C. JOHNSON & SON, LTD.

"The Wood Finishing Authorities."

(Dept. M.W.7), West Drayton, Middlesex.

Dear Sirs,

Will you please send me your illustrated book, which explains the best way for finishing Radio Cabinets.

My Name

My Address



Wireless
Licences
and how to
obtain them.

By E. Redpath

(Assistant Editor of
"Wireless Weekly").

1 / -
or 1/11d.
post free
direct.

Get an Experimenter's Licence

EVEN if a Constructor's Licence is issued, it will always be worth your while to obtain an Experimental Licence. Remember that the latter not only permits you to use just whatever apparatus you wish, but also any type of circuit. In other words, you can carry on practically free from restriction.

To get such a Licence is worth a little trouble, therefore get a copy of this book and read exactly how you have to conform to P.M.G.'s requirements and what you have to know before your application is approved. Quite a large number of Licences have already been approved and an issue on a large scale is imminent.

Radio Press
Wireless Library,
No. 11.

Radio Press, Ltd
PUBLISHERS OF AUTHORITATIVE WIRELESS LITERATURE
DEVEREUX COURT, STRAND, W.C.2.



Eventually!
Why not now?

EVENTUALLY you will need a Set which will permit you to use as many Valves as you wish—a Set which will enable you to compare Crystal rectification with Valve—a Set so selective as to cut out your local B.B.C. station and receive *all* other stations. Each one of these requirements is fulfilled by the Peto-Scott System.

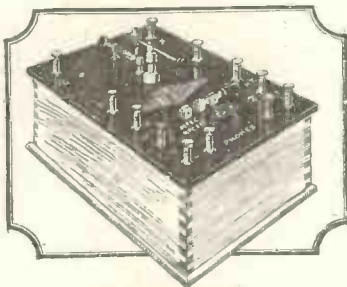

**Crystal Detector
Unit No. 6.**

Designed to enable anyone to begin the Peto-Scott System without incurring the cost of Valves and Batteries. Many experimenters, on the other hand, prefer to use a Crystal Detector for greater purity of speech. This Unit can be used in conjunction with H.F. Amplifier (No. 3) and Note Magnifier (No. 5) for Loud Speaker use. Use it with Units 1 and 2 for a complete 3-Unit Crystal Receiver of superior efficiency capable of working over unusually long distances.

Why not start now? Put an end to makeshifts and commence with a real System—one which will grow with your experience without being a drain upon your pocket. The Peto-Scott System was the first Unit System to be licensed under Marconi patents. It is still, by reason of its many original features and exclusive improvements, far ahead of any other so-called Unit System. Read more about it and how each Unit functions in a 24-page illustrated Booklet (6d. post free), entitled "Radio."

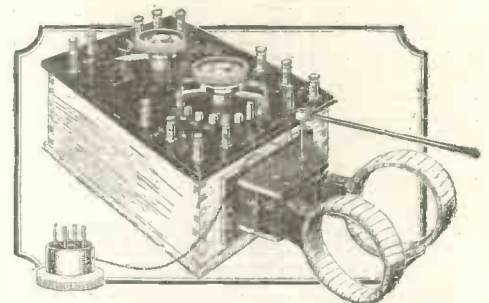

Reactode Unit No. 7.

Permits tuned Anode Circuit with tuned Reaction to be used. A six way switch gives the following circuits *without changing a single connection* :—

1. Reaction on Aerial Circuit (not to be used for Broadcast Reception).
2. Reaction as above but reversed.
3. Reaction short-circuited.
4. Simultaneous Reaction on Aerial and Anode Coil.
5. Reaction on Anode Coil.
6. Reversed Reaction on Anode Coil.

No. 4 in particular opens up an interesting field and is well worth attention from the experimenter. This Unit can be added to all existing Peto-Scott Sets. Use this Reactode Unit, its greatly improved circuits will enable you to cut out your local Stations and receive telephony over very long distances

PRICE LIST OF UNITS FOR HOME CONSTRUCTION.	
No. 1. Tuner Unit	27/6
No. 2. Condenser Unit ..	42/-
No. 3. High Frequency Amplifying Unit ..	13/6
No. 4. Valve detector Unit ..	17/6
No. 5. Low Frequency Amplifying Unit ..	33/6
No. 6. Crystal Detector Unit ..	15/6
No. 7. Reactode Unit ..	28/6
Cabinets for 1, 3, 4, 5, 6 and 7 ..	3/6
" for No. 2	7/-
Peto Coils (set of 4)	17/6
Full instructions are supplied in every box.	

PETO-SCOTT CO., LTD.

Head Office:
FEATHERSTONE HOUSE,
64, High Holborn, W.C.1.
Demonstration Lounge:
99, High Holborn, W.C.1.
Branch:
3, Wellington St., Strand, W.C.2.

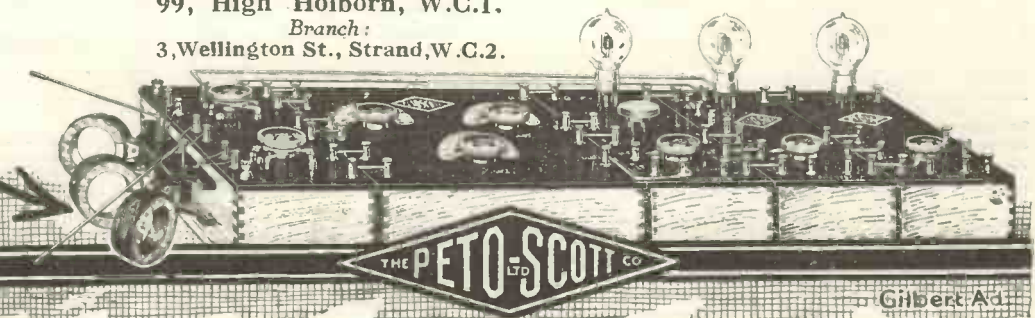

Gilbert Ad.

T. O. BUSS, Scientific Instrument Maker,

77, CLERKENWELL ROAD, LONDON, E.C.1.

Established 1850.

Exhibition Awards—London 1862. Sydney 1879. Melbourne 1880.

HEADPHONES

Genuine French Telephones, most sensitive obtainable, 6 Tungsten poles in each earpiece, 4,000 ohms with cords (Double Receivers) ... post free,

19/6

French "Brunet" Headphones 4,000 ohms 22/6 POSTAGE 9d.

French "Sidpe" Headphones, 19/- 4,000 ohms, postage 9d.

VARIABLE CONDENSERS

CONDENSERS. Complete Sets of Parts.			Assembled Complete for Cabinet Mounting.	
Approx. Capacity Micro'f'ds	No. of Plates.	Price.	Approx. Capacity Micro'f'ds.	Price.
'001	57	7/6	'001	16/-
'00075	43	6/9	'0005	12/6
'0005	29	5/6	'0003	11/6
'0003	19	4/6	'00005	5/8
'0002	13	3/6		
'0001	7	3/-		

Postage 1/- per set extra.

Fixed Condensers, with terminals on ebonite, '0003, '0005, '001, '002, '003, 1/6 : by post, 1/9 : '004, 1/9 : by post, 2/-.

Variable Grid Leak for thermionic valves, 6/- each. Composed of a special compound to vary the grid.

WIRELESS PARTS AND ACCESSORIES

Aerial Wire, 7/22 bare copper, stranded. Price per 100 ft., 2/6. By Post, 4/-.

Aluminium Vanes, 2 doz., 1/- . By post, 1/6.

Basket Coils, Oolah, 7 in set. 5/- set. By post, 5/5

Brass Washers, 2, 3, 4 or 5 B.A. ... dozen 2d.

... Nuts, 2, 3, 4 or 5 B.A. ... dozen 4d.

Brass Rod (screwed)—

2 B.A., in 12-in. lengths ... each 5d.

3 B.A., in 12-in. lengths ... each 4½d.

4 B.A., in 12-in. lengths ... each 4d.

5 B.A., in 12-in. lengths ... each 3½d.

Contact Studs, ½ in. by ¼ in., complete with nut and washer, 6d. doz.

Copper Foil Sheets, uniform thickness, 12 in. by 3 in. ... each 3d.

Crystal Detectors on Ebonite. Each 2/6. By post, 3/-

Crystal Detector, cup enclosed with glass cover, dust proof, 4/6. By post, 5/3.

Ebonite Dials, with engraved scale 0-180, 1/- each. By post, 1/8.

Engraved Ivorine Scales, 0-180 round ends, 4½d.

Filament Resistances. Each, 2/6 and 3/6. By post, 3/- and 4/-.

Inductance Coils Wound Enamel Wire, 12 by 4, 3/3. By post, 5/-.

1½ Insulating Sleeving, 5d. yd.; 6 yd. for 2/4. By post, 2/8.

Insulators, Egg, 4 for 11d. : 2/6 per doz. By post, 3/6 doz.

Insulators, Reel, 2d. each. By post, 2/6 doz.

Intervalve Transformers (low frequency), tested and guaranteed 5-1, 14/- each. By post, 15/-.

Knobs, with brass nut (2 B.A.), 4½d. each. By post, 7d. 6 for 2/- . By post, 2/6.

Large Spacer Washers, 3 doz., 9d. By post, 1/-.

Lead-in Tubes, ebonite with brass terminals, 9 in., 1/2. By post, 1/6. 12 in., 1/4. By post, 1/8.

Slider and Plunger, 5d. By post, 7d.

Slider Knob, Plunger and 13 in. rod, 8d. the set. Cannot be sent by post.

Small Spacer Washers, 6 doz. 1/- . By post, 1/4.

Switch Arms, with polished knob, bushed 2 B.A. nut, laminated blade, spring coil washer, nuts and bush, 1/6, 2/- each. By post, 1/9, 2/-.

Tin Foil, free from lead. Sheets, 17 in. by 11 in. each, 4d.

Valve Legs, with nuts and washers, 1d. each.

Valve Holders, ebonite, complete with nuts, 1/3.

TRADE SUPPLIED
Terms on Application

Terminals

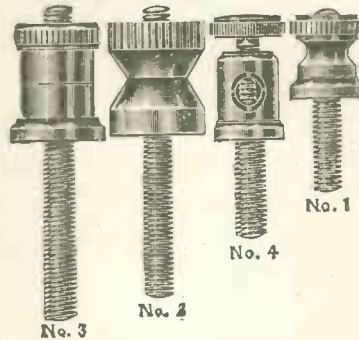

No. 3 Terminals, 2 B.A., with nut and washer, 2/- doz. By post, 2/6.

No. 2 Terminals, War Office Pattern, with nut and washer, 2/- doz. By post, 2/6.

No. 4 Terminals, telephone, with nut and washer, 2/- doz. By post, 2/6.

No. 1 Terminals, with nut and washer, 1/6 doz. By post, 2/-.

Terminals (large), aerial and earth, complete with 2 nuts and 2 washers (2 B.A.), 2 for 8d. By post, 1/-.

"EBONITE"

Postage Free. Any Size cut

		¾ in. thick		1 in. thick	
		s. d.	£ s. d.	s. d.	£ s. d.
8x1	...	7	12x10	...	7 6
4x4	...	1 3	17½x8½	...	9 6
7x5½	...	2 8	18x18	...	12 10
10x6	...	3 9	36x18	...	1 4 9
17x5	...	5 3	7 lb.	...	1 4 9

Instrument Wires

British Made Copper Wires.

Prices Per lb. Other sizes in stock. A charge of 3d. extra is made for reeling off in small quantities. Postage extra.

		yds. ohms.		S.W.G. per lb. per 1,000 S.C.C. D.C.C. S.S.C. D.S.C.		Enmld.	
		yds.	ohms.				
22	140	39	2/9	3/6	4/-	5/-	2/7
24	230	63	3/-	3/6	4/6	6/-	2/8
26	340	95	3/7	4/1	5/-	8/-	3/2
28	530	140	4/4	4/8	6/-	9/-	3/6
30	716	200	5/-	5/6	7/-	10/-	3/10
32	950	262	6/-	7/3	8/-	12/6	4/2
34	1,300	362	7/-	8/3	9/-	13/6	4/4
36	2,000	530	8/8	10/-	12/-	15/6	4/8

Wireless Crystals

"Hertzite" 1/6 Carborundum 6d.

Zincite 1/- Molybdenite 6d.

Silicon 6d. Iron Pyrites 6d.

Bornite 6d. Galena 6d.

Copper Pyrites 6d. Graphite 6d.

Wood's Metal 6d. Tellurium, dram 2/6

— Post free —

Intervalve Transformers

Size 3x3x1½. Ebonite Top and Bottom, Ratio 5 to 1 Post Free, 15/-

The most suitable transformer for panel mounting.

Celluloid Accumulators

BEST BRITISH MAKE.

Volts.	Amp. hrs. continuous	Amp. hrs. ignition	Price.	Post
Oldham 6	20	40	28/-	2/-
Rotax 4	20	40	19/-	1/9
M.A.L. 4	20	40	19/-	1/9
2	20	40	10/-	1/-

H.T. Batteries, 30 volt, 6/- (by post, 7/6)

H.T. Batteries, 60 volt, 12/- (by post, 13/6)

Inductance Tubes

Cardboard

12x2½ . . 4d. Post 2½d. 12x3½ 6d. Post 4d.

12x3 . . 5d. " 3½d. 12x4 8d. " 5½d.

Mahogany Boxes

		Polished		Post.	
4½x4½x3½ in.	3/-	3d.
4½x4½x5 in.	3/6	6d.
6½x6½x4 in.	4/6	1/-
13x6½x4 in.	7/-	1/-

VARIOMETERS

FOR GENERAL BROADCASTING

Price 6/- each

Post Free 6/9

No. 14

Price 7/6 complete.

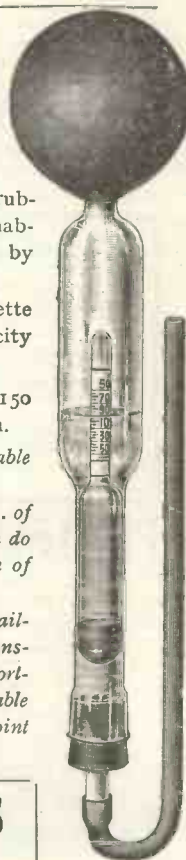

SYRINGE HYDROMETERS SPECIFICATION.

BULB—Heavy moulded rubber of full capacity enabling pipette to be filled by slight compression.

Fitted with a 6-in. pipette having a flotation capacity of half a fluid ounce.

HYDROMETER scaled 1150 —1300 S.G. or at option.

Designed for small portable cells.

For ascertaining the S.G. of the electrolyte in cells which do not permit of the insertion of other Hydrometers.

Adopted by leading Railway Companies and Transport organisations for all portable cells. Eminently suitable for determining dilution point of Wireless cells.

THE SIGN OF QUALITY

WHEN YOU BUY AN INSTRUMENT BEARING THIS MARK YOU ARE GETTING THE BENEFIT OF 30 YEARS' MANUFACTURING EXPERIENCE



COMPLETE WIRELESS SETS & COMPONENTS OF THE FINEST DESIGN, WORKMANSHIP AND EFFICIENCY.

FULLY ILLUSTRATED LIST PRICE 6d. POST FREE

GAMBRELL BROS. LTD.

76, VICTORIA ST., S.W.1
 'Phone - - Vic 9938
 Works: SOUTHFIELDS

CUT IT OUT!

You can eliminate all the interference and confusion that now spoils your reception—Static, Morse, atmospherics, and interruptions from transmitting stations other than the one to which you are tuned—by fitting to your present receiver *without alteration* an

'Autoveyors' 3-E.V.C.

The only Complete Absorber of Disturbances. British Patent 17703/22.

Price.	Over-all	Dimensions.
	s. d.	Length. Breadth. Depth.
*0005 mfd. 30 0	7"	4 1/2" 3"
*001 mfd. 40 0	7"	4 1/2" 4"

*Capacity essential for interference elimination. Wherever you may be, whatever the station you desire to receive, the "Autoveyors" 3-Electrode Variable Condenser gives you just what you want, exactly when you want it. Get one now and learn the delight of listening-in without disturbance.

Obtainable from all reputable dealers or direct for remittance with order from:—

AUTOVEYORS LTD.,

Radio Engineers and Contractors,
 84 VICTORIA STREET, LONDON, S.W.1.
 Write for General Catalogue—the most comprehensive list in the Wireless Trade—3d., Post Free.

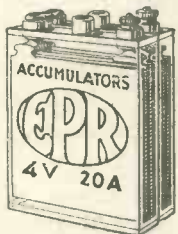

ACCUMULATORS REDUCED PRICES

The E.P.R. Accumulators have 20 years' reputation for dependability and efficiency.

ALL CELLS GUARANTEED



WIRELESS ACCESSORIES VALVES.

- DUTCH, FOR DETECTING, 8/11.
- DUTCH, PHILLIPS "R," 10/11
- MARCONI DITTO, 15/6.
- EDISWAN, 14/6.
- MULLARD "ORA," 15/-.
- Postage, 6d. extra.
- 'PHONES IN STOCK.
- FRENCH, 17/11.
- BRUNET, 22/6.
- FEDERAL, 25/-.
- T.M.C., 26/11.
- STERLING, 31/11.
- BROWN'S, 29/11
- Postage, 1/- extra.
- BASKET COILS, 2/11 set 6.
- CRYSTAL DETECTORS, 1/6, 2/-, 2/6, 3/6.
- VALVE HOLDERS, 1/- each.

POPULAR TYPE CLEAR CELLULOID CASES.

No.	Volt- age.	Ignition Cap. Amps.	Act. A.H. Cap.	Carriage Price. Extra.
1000	4	17	8	9/11
1310	4	20	10	12/11 1/6
1315	4	30	15	14/11
1320	4	40	20	16/11
1330	4	60	30	22/6 2/3
1340	4	80	40	29/-
1420	6	40	20	27/6
1430	6	60	30	33/9 2/6
1440	6	80	40	39/6
1450	6	100	50	45/6 3/6

"C" TYPE ACCUMULATORS

Special Features. Extra Stout Cases (Celluloid) Specially Formed Lattice Grid Plates. Absolutely the Finest Cell yet produced.

No.	Volt- age.	Ignition Cap. Amps.	Act. A.H. Cap.	Carriage Price. extra.
1720	4	44	22	22/-
1730	4	66	33	27/6 2/3
1740	4	88	44	35/-
1820	6	44	22	33/6 2/6
1830	6	66	33	42/6
1840	6	88	44	52/6 3/6
1850	6	110	55	63/-

RICHFORD & CO., 153, Fleet Street, LONDON, E.C.4
 Established 1878.
 Telephone: HOLBORN 6120.

SOLVED! The problem of charging your Filament Accumulator.

THE "ELLA" CONVERTER

connects to direct current circuits of any voltage

Output 5 amps 9 volts.

No attention required.

Saves its cost in a few months.

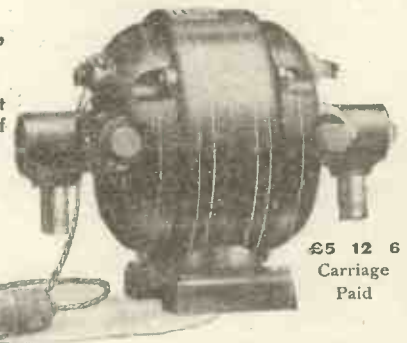

£5 12 6
 Carriage Paid

also A.C. £7 12 6

Double Scale Voltmeters
 for measuring Filament and Plate
 Volts on ONE Instrument.
HUNDREDS ALREADY SOLD.

British (B.B.C.) Headphones
 4,000 ohms, 32/-
LIGHTEST and BEST.

"STAPLEITE"

The LIVE Crystal.
 Sample, 2/- Post free.



20/- Post Free.

TRADE SUPPLIED.

LIONEL ROBINSON & CO.
 (Dept. M.W.), 3, Staple Inn, London, W.C.1.

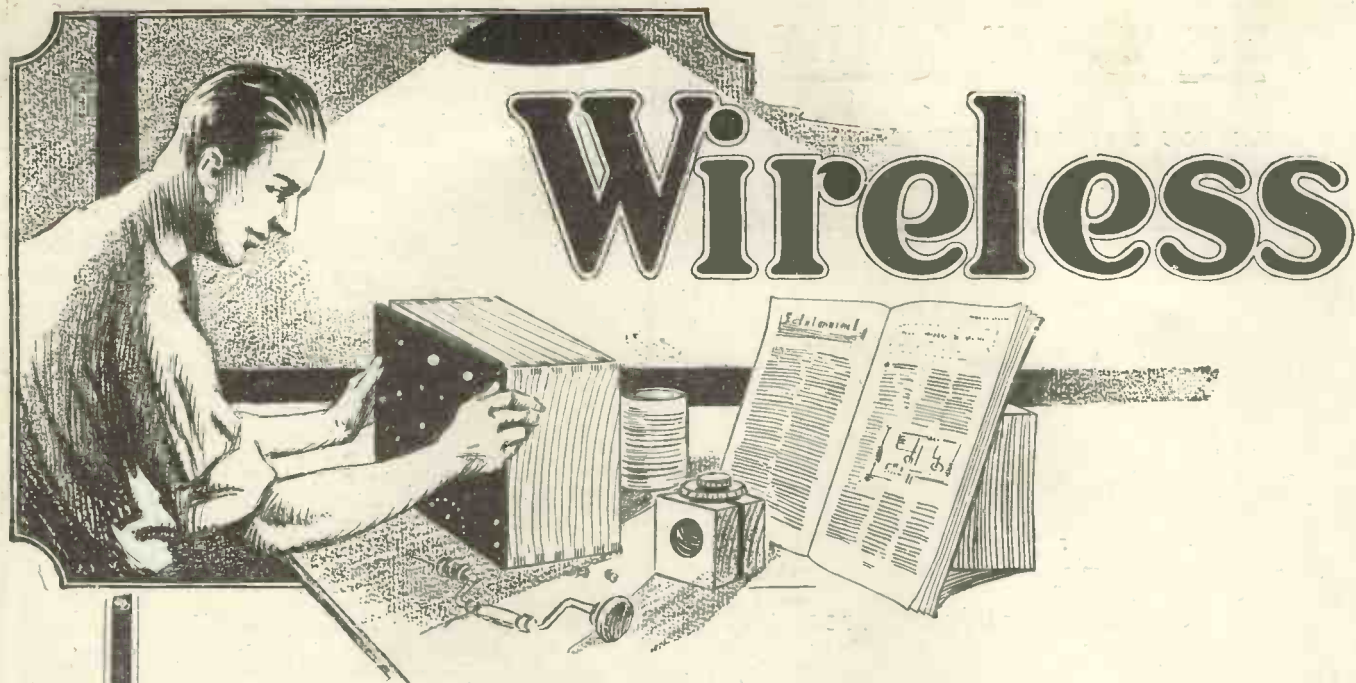

The Experimenter's own Weekly —

THREE months have elapsed since the first issue of *Wireless Weekly*—time enough to look back and view the progress that has been made.

Wireless Weekly was produced to fill a definite need. The instantaneous success of *Modern Wireless* showed that there was an ever-growing public quick to appreciate a good readable technical Magazine, which would interest and instruct.

There is one disadvantage inherent in every monthly Magazine, however, and that is that the necessary four weeks between each issue make continuity difficult and prevent the introduction of topical and serial Articles.

Wireless Weekly was produced to fill this very definite need. Its Articles are bright and up-to-the-minute. Whatever the latest developments of Radio—latest discoveries of Circuit combinations—recent inventions and so on—all are discussed in detail at the earliest possible moment.

As an appreciative reader of *Modern Wireless* we ask you to buy a copy of this week's *Wireless Weekly*. You will at once realise that, between them, these two publications cover every requirement, and that you'll need no other.

Every
Wednesday



HAVE A GOOD ONE

The



MANY wireless sets are not all they should be. An otherwise good set is frequently spoiled by a poor transformer.

Twin-Coil Intervalve Transformer

is a great advance in transformer design. Its characteristics compared with other transformers are—

- High Primary Inductance.*
- Much lower Self Capacity.*
- Gives greater amplification.*
- Entire absence of distortion.*

Many users have replaced their transformer by an "M-L." with remarkable results—**Clearer and Stronger Signals and greater range.** Only by using the best component parts will you get the best results from your set.

Do you wish to improve your set? Are you adding extra valves? If so, use the best Transformer—an "M-L."

An experimenter writes us as follows:—

2, P.V. Kenilworth.

RE L.F. INTERVALVE TRANSFORMERS.

I have now carefully tried out your transformers and have pleasure in reporting that they are giving exceptionally good results.

As you are aware, I have tried out practically every make of L.F. Transformer available to the amateur, and, in my considered opinion, your latest production is superior to anything I have previously tested.

G. SMITH CLARKE, M.I.A.E., M.S.A.E. (U.S.A.).

Member Radio Soc. of Gt. Britain.

Send for Illustrated Leaflet.

The M-L Magneto Synd. Ltd.

Transformer Dept., Victoria Works, Coventry.



Tested on 600 volts. Dust and damp proof. Perfect Insulation. Primary to secondary ratio 1 to 4. No distortion.

Patent No. 33604/22.

PRICE

30/-

Carriage Paid.

Cash with Order.
Ready for mounting
We invite Traders to write us for terms.

"HAVE A GOOD ONE"

REDUCED ADVERTISEMENT RATES

During the Summer Months the Publishers of WIRELESS WEEKLY have pleasure in offering **REDUCED** rates for Display Advertising Space as follows, commencing May 23rd.

ORDINARY POSITIONS.

13 insertions consecutive	-	£15 per page and pro rata.
6 " " "	-	£15 plus 5% per page and pro rata.
1 to 5 " " "	-	£15 plus 10% per page and pro rata.

NEXT MATTER (In columns only).

13 insertions consecutive	-	£20 per page and pro rata.
6 " " "	-	£20 plus 5% per page and pro rata.
1 to 5 " " "	-	£20 plus 10% per page and pro rata.

SCHEFF PUBLICITY ORGANISATION, LTD.

(Advertisement Managers, Wireless Weekly and Modern Wireless).

125, PALL MALL, LONDON, S.W.1.

Phone—Regent 2440 (2 lines).

NOW IN THE PRESS.

The Construction of Crystal Receivers

by Alan L. M. Douglas

(Author of "The Construction
of Amateur Valve Stations.")

Contents :

- CHAP. 1.—The Crystal Detector
—its Development and Design.
- CHAP. 2.—Crystal Reception
Circuits.
- CHAP. 3.—Inductances for
Crystal Work. (Single layer
solenoid, honeycomb, basket,
slab, inductively coupled,
etc.)
- CHAP. 4.—Condensers Fixed and
Variable. Full constructional
details.
- CHAP. 5.—Telephone Headgear
—including transformers and
loud-speakers.
- CHAP. 6.—How to make a Crystal
Receiver for British Broad-
casting. (Wave-length range,
250-600 metres.)
- CHAP. 7.—How to make a Long
Range Receiver. (Wave-
length, 300-3,000 metres.)
- CHAP. 8.—The "Mark III."
Short-wave Government
Tuner, and useful conversions
and modifications.
- CHAP. 9.—Aerial and Earth
Circuits—their faults and
remedies.
- CHAP. 10.—Valve amplifiers for
Crystal Receivers—high and
low frequency circuits, switch-
ing devices.

IT is not so very long back to the time when all important work was done with the Crystal. Every ship's operator can tell of his experiences in receiving messages transmitted hundreds of miles away. In these days of valve transmission and reception, we are all apt to overlook the fact that the Crystal as a *rectifier* is still unsurpassed. This new book can be thoroughly recommended to all wireless enthusiasts—the more advanced will find a great deal of useful and authoritative information which is entirely new and which is directly the result of the author's own experiences. The novice, on the other hand, will find that this Book is probably the most complete Book solely devoted to Crystal Receivers which has yet been published.

2/6

Sold by all Booksellers
and Newsagents, or 2s. 8d.
post free direct.

RADIO PRESS LTD.—Devereux Court, STRAND, W.C.2.



"TURRET"

WIRELESS MASTS AND AERIAL EQUIPMENT, as supplied to H.M.

KING of ITALY

Designed by Naval Experts like a ship's mast. Columbian pine, painted 3 coats. 500 in use. No current jump or steel to rust. Unbreakable and easy to fix. Rigged by ex-seamen. Light, rigid and sent complete, no extras. Fixings for any roof or confined space. 28ft. mast in 2 sections, Complete - - £2 19 6
36 ft. mast in 3 sections, Complete - - £3 19 6
42 ft. mast with telescopic top pole, hoisted after lower sections are stayed - - £4 9 6
56 ft. mast with 2 top sections telescopic and extra guys, etc. Complete - - £6 18 6
'Turret,' two, 28ft., 37/6
do. do. 42ft., 69/6

SIMPSON & BLYTHE, 8-9, Sherwood Street, Piccadilly, and most Wireless Stores. Phone: 2650 Gerrard.



RADCOM VARIOMETERS

Type H. Designed mainly for use with crystal receiving sets. An exceptionally well finished article designed to cover a wave range length of approximately 150 to 600 metres, when used with a standard P.M.G. aerial.

Type H.R. Same as above, but heavier wound.

- Type H, Variometers .. 21/-
- Type H.R. Variometers .. 23/-
- Type H.R. Varic-coupler .. 23/-

RADCOM POTENTIOMETERS

INCREASE YOUR RANGE
300 ohms Resistance.
Panel Mounting.
Adjustable, Contacts.
increased Signal strength.
Low Price.
RADCOM Quality.
PRICE 7/-

Radio COMPONENTS, LTD

18 Rathbone Place, LONDON, W.1.
Telephone: Mu eum 3485.
Telegrams: Radponents Westcent, London.

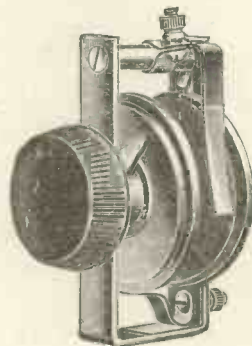

(E.P.S. 26)

"IGRANIC"

Designed for operation in conjunction with any of the standard makes of valve in detector amplifying or multi-stage magnifying circuits.

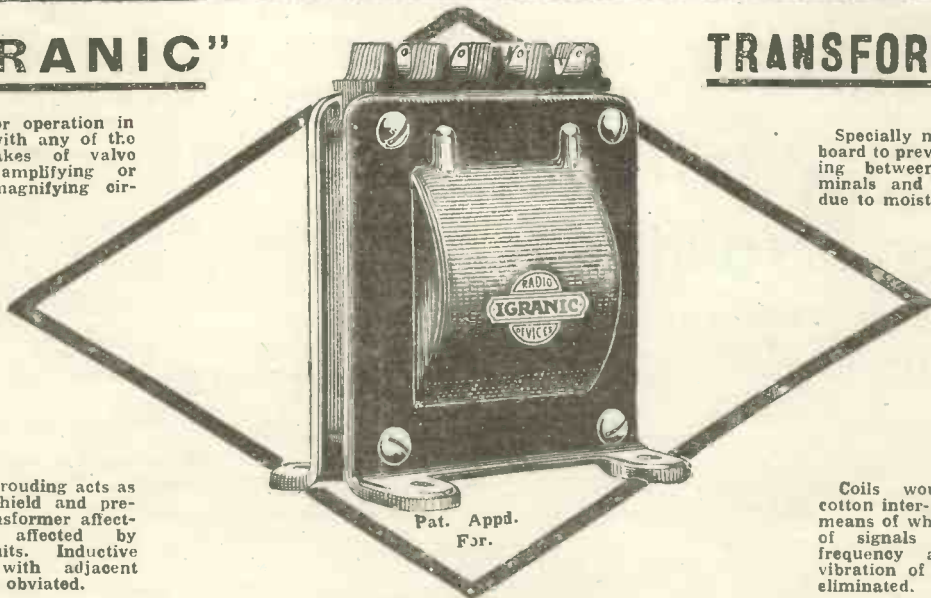

TRANSFORMERS.

Specially moulded terminal board to prevent short circuiting between adjacent terminals and surface leakage due to moisture.

The steel shrouding acts as a magnetic shield and prevents the transformer affecting or being affected by external circuits. Inductive interference with adjacent apparatus is obviated.

Coils wound by patent cotton inter-weave process by means of which all distortion of signals due to high-frequency and mechanical vibration of wires is entirely eliminated.

Pat. Appd. For.

Write for Leaflets Z65.

Glasgow—50, Wellington Street.
Manchester—30, Cross Street.
Birmingham—73/4, Exchange Bldgs.

149, QUEEN VICTORIA STREET, LONDON.



Bradford—18, Woodview Terrace.
Cardiff—Western Mail Chambers
Newcastle—90, Pilgrim Street

WORKS: ELSTOW ROAD, BEDFORD.

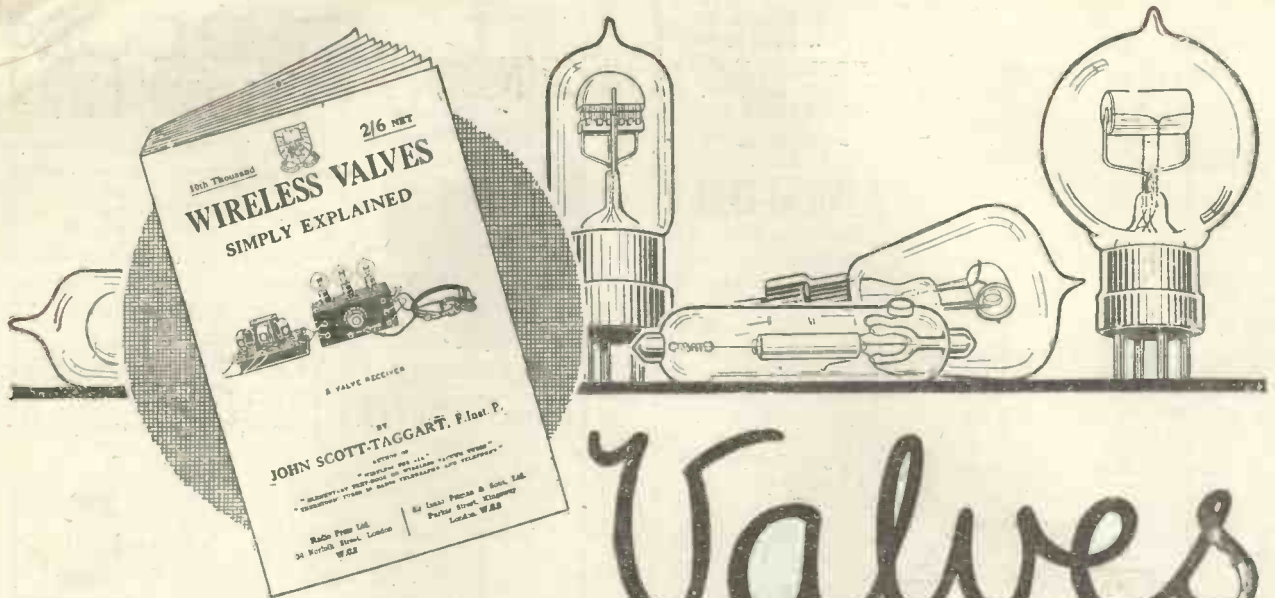

Valves

THE Valve—the most important part of a Receiving Set, yet probably the least understood.

Get to know how the Valve works—how it rectifies, amplifies and oscillates—and you have mastered the rudiments of Wireless. *Without this knowledge you are working in the dark.*

This Book, by the Editor of *Modern Wireless*, is full of the most interesting facts about the Valve, and its explanations can be understood by anyone. Get a copy to-day.

Radio Press
Wireless
Library, No. 10

From all Booksellers
or Newsagents, or
2/8 post free.

2/6

Wireless Valves Simply Explained

By

JOHN SCOTT-TAGGART, F.Inst.P.

Contents.....

- The Theory of the Thermionic Valve.
- The 3-Electrode Valve and its applications.
- Cascade Valve Amplifiers.
- Principles of Reaction Amplification and Self-oscillation.
- Reaction reception of Wireless Signals.
- Continuous Wave Receiving Circuits.
- Valve Transmitters.
- Wireless Telephone Transmitters Using Valves.
- Broadcast Receivers.

RADIO PRESS, LTD.

Devereux Court,
STRAND, W.C.2

Gilbert Advt.

All Previous Lists Cancelled.

Phone: Willesden 1336

THE WILKINSON MOTOR & ENGINEERING CO.,
 10, 12, 14, 29, 31, 33, Lonsdale Rd., Kilburn, N.W.6.
 H. E. WILKINSON, M.J.I.E., Proprietor. Same Address since 1900.

"EIFFEL TOWER" MASTS

The Masts are built of selected wood soaked in creosote, all main parts are screwed together (not merely nailed) and banded with galvanised iron. The Mast is sent out in 10-ft. sections, complete with screws for assembling. These Masts are triangular in shape and made of triangular material, giving great strength combined with lightness.

PRICES:—CASH WITH ORDER.		CARR. FORWARD.	
20 ft.—£2 0 0	... Weight 30 lb.	... Base Size 16 in.	
30 ft.— 3 0 0	... " 50 "	... " 22 "	
40 ft.— 3 17 6	... " 70 "	... " 26 "	
50 ft.— 4 15 0	... " 90 "	... " 29 "	

MAST SUNDRIES—

Seven Strand Rigging Wire in 50 and 100 ft. coils, 1/9 and 3/6 each.
 Rigging Strainer Screws (Gal.) 1/- each.
 Wall Hooks ... 1/6 doz.

Galvanised Pulleys ... 1/6 each.
 Special Tarred Hemp Halyards, 50 ft. 2/6; 100 ft. 5/- and pro rata.
 Green Shell Insulators... 6/- doz.

BEGINNERS' GUIDE to WIRELESS

BEST BOOK OBTAINABLE

Explains in plain everyday language everything you wish to know about Wireless Telegraphy.

HOW TO ERECT, CONNECT AND MAKE

the apparatus required, also full instructions for making coils, tuners, and complete valve and crystal sets. Instructions and diagrams for making the latest two-valve tuned anode receiver are alone worth four times cost of the book: 112 pages, price 1/- Post Free.

SAXON RADIO CO.

(Dept. 24),

SOUTH SHORE, BLACKPOOL

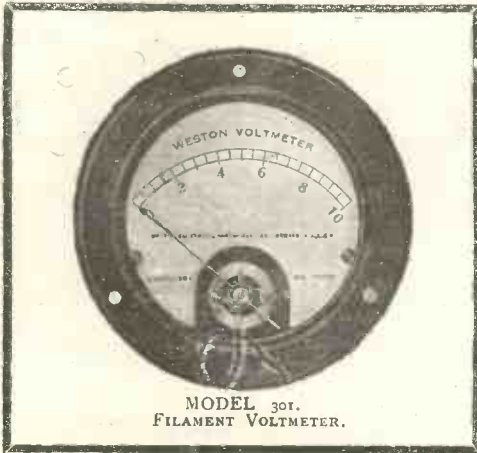

MODEL 301.
 FILAMENT VOLTMETER.

**The WESTON
 Filament Voltmeter**

For Receiving Sets.

MODEL 301.

Simplified tuning by eliminating guesswork as to valve adjustments. Filament voltage control increases the life of the valve from two to three times.

The Weston Filament Voltmeter is accurate and can be relied upon for duplication of results.

**ALL THIS MEANS
 BETTER RECEPTION!**

List Price £2 : 9 : 0.

WESTON ELECTRICAL INSTRUMENT Co., Ltd.,

Audrey House, Ely Place, Holborn, E.C.1.

Telephone: Holborn 2029. Telegrams: "Pivote1, Smith, London."

ECONOMIC ELECTRIC LTD.

NEW

**"Xtraudion"
 THREE ELECTRODE
 VALVE**

Oscillates
 Rectifies
 Amplifies

Filament consumption 0.5
 amps. at 4 volts; Anode
 potential 30—75 volts,

PRICE 15/-

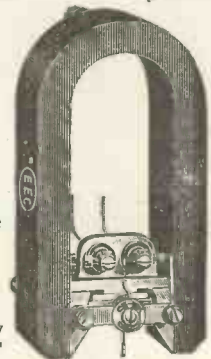

A very limited number available.
BUY NOW

Write
 to-day



**OUR 40-PAGE
 RADIO BOOK**

with over 250
 illustrations of
 everything for
 the Radio
 Recruit or Re-
 search worker,
 mailed post
 free for 4d.

**DEAL
 WITH
 "EEC"
 IT PAYS!**

**WESTON
 MOVING COIL
 RELAY**

The most sensitive Relay
 in existence, works on a cur-
 rent of 50 Micro Amperes.
 The best Relay for record-
 ing wireless signals.

New and perfect condition.

Price 18/6
 Present manufacturers price
 6/9

TRY "RECTARITE,"
 the Synthetic CRYSTAL
 that makes
LOUD SPEAKERS TALK
 Large specimen 1/6

Head Office: 10, FLEETWOOD SQUARE, LONDON, W.1. Showrooms: 303, EUSTON RD., N.W.1. Branch: TWICKENHAM

MARKONITE CRYSTAL

Tested and Guaranteed.

MARKONITE CRYSTAL

Use with any wire contact.

MARKONITE CRYSTAL

Sensitive in every spot.

MARKONITE CRYSTAL

Supplied in sealed boxes only.

MARKONITE CRYSTAL

No battery needed.

Trial box containing two Crystals, post free, for 2/-.

Trade. Ask for catalogue. All crystals supplied by weight.

**ROSE BROS.
 LONDON.
 GLASGOW.**

Electrical Co., Ltd.,
 25-27, Milton Street, E. C. 2.
 194a, St. Vincent Street.

COUPON

Questions and Answers

"MODERN WIRELESS

July, 1923.

See Page xl.

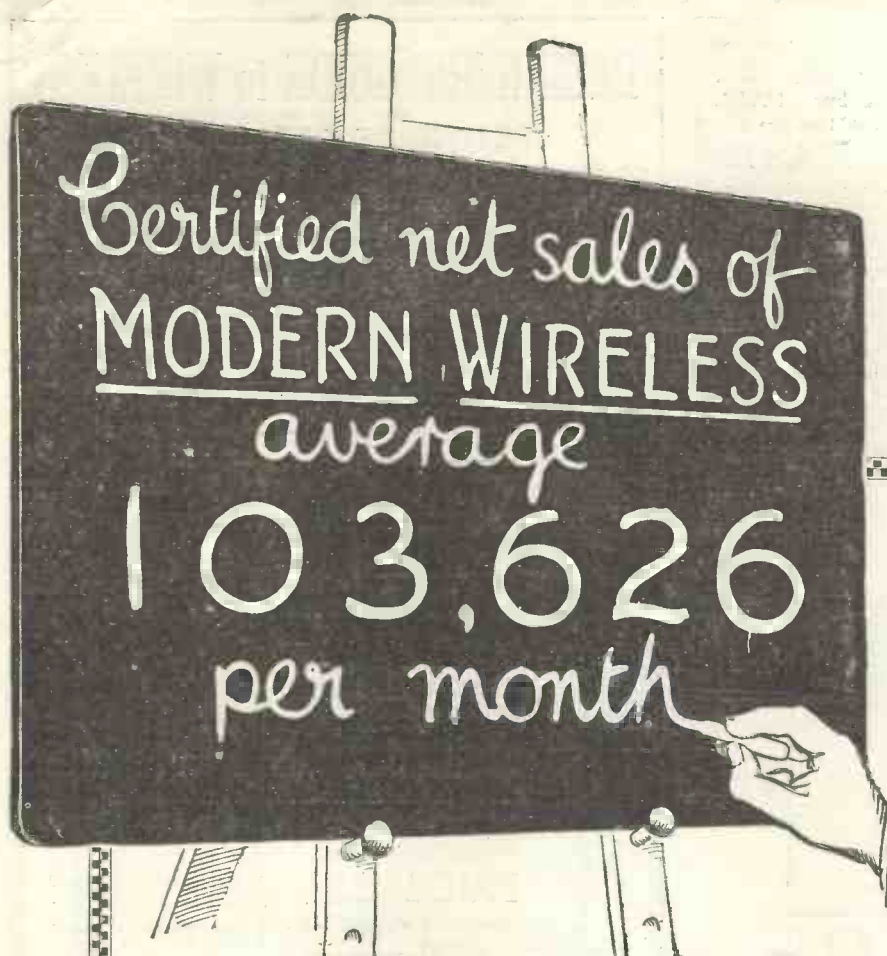

The first
Net Sale
Certificate
of any
Wireless
Magazine

Cheap Advertising

—reach 100,000 actual buyers at
a cost of only 6s. per thousand

All enquiries for rates,
space, etc., to Scheff
Publicity Organisation
Ltd., 125, Pall Mall, S.W.1

MODERN WIRELESS gives its advertisers three distinct advantages over any other Wireless publication.

1.—It has the largest guaranteed sale of any Wireless Magazine—weekly or monthly—in the country. This means that the advertiser knows exactly what he is getting for his money.

2.—As a Monthly Magazine, it is read more leisurely and—nine times out of ten—kept for future reference. Your advertisement, therefore, has a much longer life.

3.—Every reader of *Modern Wireless*—because he spends 1s. for his copy—is obviously of the right type. Keen, with money to spend, always ready to try out new apparatus—an ideal prospect. Remember that there are 100,000 of them!

MODERN WIRELESS
Britain's best Wireless Monthly



The Sequel to "Wireless for All"

AFTER your Wireless friend has read "Wireless for All" get him a copy of this Book. He will be deeply interested in the practical explanation as to how a Wireless Set receives and will appreciate the elementary instructions for building an efficient Crystal Set from the simplest of materials.

Simplified Wireless

By JOHN SCOTT-TAGGART
F.Inst.P.
(Editor of Wireless Weekly)

Contents.....

Some General Remarks regarding Wireless—The Telephone Receiver—Transformers—Air-core and Iron-core Transformers—Step-up and Step-down Transformers—Inductances—Condensers—Frequency and Wavelength—The Aerial Circuit of a Wireless Receiver—The Use of a Variable Condenser when Tuning—The Crystal Detector—A Receiver Using a Variable Condenser—Loose-coupled Circuits—Notes on the Erection of Aerials—Frame Aerials—Loud Speakers—How to Make a Simple Broadcast Receiver—Operation of the Receiver—The Variable Inductances—Some simple forms of Crystal Detector—The Telephone Condenser—The Complete Arrangement of the Apparatus—Operation of the Circuit.

Post Free direct
1/1½

Sold by all Book
sellers and published by

**RADIO
PRESS
LTD.,**

Devereux
Court,
Strand, W.C.2



EDISWAN VALVES

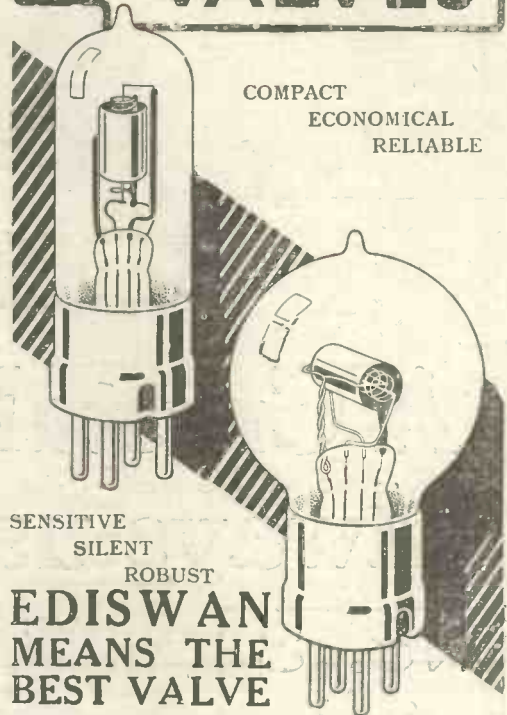

Actual performance has proved beyond all question the superiority of the Edison Valve for wireless work. Every day adds to its reputation.

TYPE A.R. TYPE R.
15/- 17/6

We have had unique experience in the development and manufacture of the Thermionic Valve. The first experiments in connection with the investigation of the "Edison Effect" on which the working of a valve depends were carried out at our Ponders End Works by Prof. J. A. Fleming, who was the company's Scientific Adviser.

WHAT USERS SAY: A typical example of the splendid results constantly being brought to our notice:—

"Dear Sirs,
Last December I purchased one of your A. R. type Receiving Valves, and I could not wish for a better Valve. My set is a home-made single Valve, Variometer tuned. My aerial is 18 ft. high and 110 ft. long, with this I can receive Glasgow, 250 miles distance, Newcastle, Manchester, London, Cardiff, Birmingham, 12 miles away.
Dudley, 1/6/1923.

Also manufacturers of complete Receiving Sets, Accessories and H.T. and L.T. Batteries. Dealers should write at once for particulars and terms. Descriptive leaflets free on request.

**THE
EDISON SWAN ELECTRIC
CO., LTD.,**

Contractors to H.M. Admiralty, War Office, Royal Air Force.
**123/5, Queen Victoria Street, E.C.4,
and 71, Victoria Street, S.W. 1.**
WORKS: PONDERS END, MIDDLESEX.

Branches in all Principal Towns.



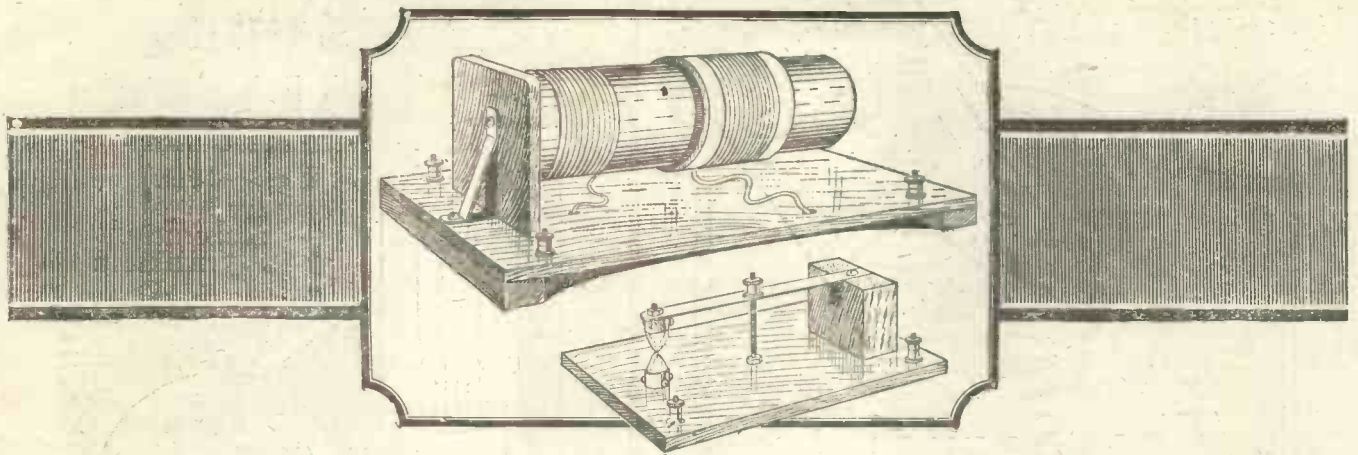

A Crystal Set is always useful—

No. 3
of the
RADIO PRESS
Series

WHEN your Accumulator runs down, or your Valve burns out, or your H.T. Battery suddenly develops noises—these are the occasions when you would give almost anything for some means of “carrying on.” Why not forestall these possibilities by making a Crystal Set now?

This new Book by John Scott-Taggart, Editor of “Wireless Weekly” describes three useful Sets which can be made by anyone without special skill in the use of tools. In fact, the simplest of them (illustrated above) can even be constructed of material you would find around the house.

All have been designed to give good results with a range of, say, 25 miles from your nearest Broadcasting Station.

Get a copy of this Book to-day—even if your present Set seems immune from breakdown, you will never regret the time spent on building a Crystal Receiver.

Contents

- Some General Principles.
- The Question of Licences.
- Parts of the Wireless Receiver.
- Crystal Detectors.
- Inductance Coils.
- The Construction of the Crystal Detector.
- Connecting up the Receiver.
- Operation of the Set.
- The Variable Inductances.
- The Telephone Condenser.
- Operation of the Circuit.
- Erecting your Aerial.
- Insulating your Aerial.
- General Dimensions of the Aerial.
- Constructional Details when using Masts.
- The Down-lead and Lead-in.
- Adjusting the Span of the Aerial.
- Twin-wire Aerials.
- The Earth Connection.
- The Aerial-earth Switch.
- Some remarks on Tuning.
- Receiving Paris Signals.



Radio Press, Ltd
PUBLISHERS OF AUTHORITATIVE WIRELESS LITERATURE
BEVEREUX COURT, STRAND, W.C.2

From all Booksellers and Newsagents, or 1/7 post free direct

How to make your own Broadcast Receiver

By John Scott-Taggart, F.Inst.P.

1/6

NEGRETTI & ZAMBRA

The finest Loud Speaker.

The Western Electric Loud Speaking Equipment consists of a powerful Loud-speaking Receiver, complete with Two-stage Power Amplifier, of a special type. Western Electric valves are used on this set and special precautions are taken to eliminate distortion.

Write for new List of Wireless Sets and Accessories.

NEGRETTI & ZAMBRA

Wireless Department
38 HOLBORN VIADUCT
LONDON, E.C.1.

Agents for the
Western Electric
Company.

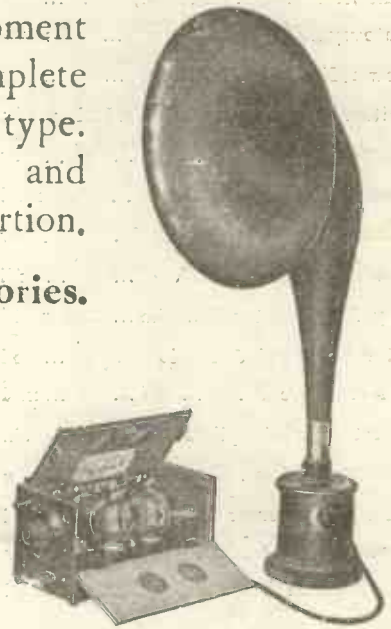

Established 1850

Immediate Delivery.

Trade Supplied.

BRING THE STARS OF OPERA TO YOUR HOME

BUT hear them through Ericsson 'Phones— every voice-modulation, every intake of breath, every liquid note of the tenor or soprano, unspoil by distortion—too common a 'phone fault.

Prices 31/- 2,000 ohms, 32/- 4,000 ohms.

Write to-night for Free List.

The BRITISH L.M. ERICSSON MFG. Co.,
International Buildings,
67/73, Kingsway,
London, W.C. 2.

Ericsson Telephones



Look for these marks when buying Ericsson Telephones.

Selling Agents
Scotland: 57, Robertson St.,
Glasgow.
Newcastle-on-Tyne: Milburn
House,
Manchester: 105/107,
Corporation Street.
Nottingham: W. J. Furze & Co.,
Lancaster Street.
Birmingham: 14/15, Snow Hill

Index to Advertisers

PAGE	PAGE	PAGE
American Hard Rubber Co., Ltd. ... iv	Elwell, Ltd. (C. F.) ... x	Raymond (M.) ... vi-vii
Autoveyors, Ltd. ... xxvii	Fellows Magneto Co., Ltd. ... xv	Richford & Co. ... xxvii
Bower Electric, Ltd. ... iv	Gambrell Bros., Ltd. ... xxvii	Robinson, Lionel & Co. ... xxvii
British L.M. Ericsson Mfg. Co. Ltd. xxxix	General Electric Co., Ltd. ... xiv	Rogers, Foster & Howell, Ltd. ... v
Burne-Jones, Ltd. ... iv	General Radio Co. ... xi	Rose Bros. ... xxxv
Buss (T. O.) ... xxvi	Graham (A.) & Co. ... xxi	Saxon Radio Co. ... xxxv
Cable Accessories Co., Ltd. ... xxxv	Igranic Electric Co., Ltd. ... xxxiii	Simpson & Blythe ... xxxiii
Canadian-Brandes, Ltd. ... xii	C. H. Johnson & Co., ... xxii	Sterling Telephone and Electric Co., Ltd. ... iii
City Accumulator Co., The ... Cover iii	Marconi Wireless Telegraph Co. Ltd. ix	Tingey Wireless, Ltd. ... xvi
Cline Electrical & Radio Co. ... xl	M.L. Magneto Syndicate, Ltd. xxxi	Waterloo Electric Co. ... iv
Cessor Valve Co. ... xx.i	Mullard Radio Valve Co., Ltd. ... xiii	Western Electric Co., Ltd. ... Cover ii
Directory of Suppliers ... xvii-xviii	Negretti & Zambra ... xxxix	Weston Electrical Instrument Co., Ltd. ... xxxv
Drummond Bros. ... v	Peto-Scott Co., The ... xxv	Wilkinson Motor Co. ... xxxv
Dubilier Condenser Co. (1921), Ltd. xvi	Radio Communication Co., Ltd. ... xix	
Economic Electric Co. ... xxxv	Radio Components, Ltd. ... xxxi.i	
Edison Swan Electric Co., Ltd. xxxv.i	Radio Instruments, Ltd. ... Cover iv	

USE THIS COUPON

CUT HERE

In connection with your announcement in MODERN WIRELESS, please supply me with:

Enclosed please find remittance of.....
(Leave blank if not an order)

If an open envelope is used in applying for catalogues a half-penny stamp will cover postage.

Name.....

Address.....

Date.....

CUT HERE

Cline Electrical & Radio Co.

293, REGENT ST., LONDON, W. 1.

Phone: Mayfair 1313. (Near Polytechnic)

**EVERY ARTICLE HERE IS A BARGAIN
IN EVERY SENSE OF THE WORD.**

Altophone Crystal Set (B.B.C.) Dust-proof Detector	Price 52/6
Ericsson Phones (B.B.C.)	" 17/6
Thomson-Houston Phones - 4000 Ohms	Price 19/6
Brown Phones "A" Reed Type 120 Ohms super-sensitive. M.k.r.'s price 58/6	Price 30/-
Intervalve Transformers Ratio 5:1 (guaranteed)	Price 15/-
Variometer De Luxe Engraved ebonite knob & dial	Price 5/-
Enamelled Aerial Wire 100ft. "	2/6
6 Volt 60 Amp. Hour ACCUMULATORS	" 29/6

(Postage 1/- on each of the above.)

Mail orders dealt with in rotation on the basis of "Money back if not satisfied."

Marcon phone, Geophone & all standard sets in stock.

We install our instruments in Clients' homes and guarantee satisfaction.
Write for our new catalogue of ALL WIRELESS APPARATUS.

THE MOST STARTLING WIRELESS OFFER EVER MADE

Test the Wonderful FULLER "BLOCK" TYPE ACCUMULATOR at Our Expense !!

TENS OF THOUSANDS OF PEOPLE who have used this famous Accumulator would never again dream of purchasing the old-fashioned "plate" type, because they have proved its numerous wonderful advantages, not by glowing accounts in advertisements, but by the best proof of all

BY ACTUAL USE AND PRACTICE

To those who, for some reason or another, have not yet convinced themselves that the "BLOCK" Accumulator is infinitely superior to any other on the market, we have decided, at no small cost to ourselves, to invite everybody to test this Accumulator

AT OUR EXPENSE.

We are therefore giving away, **ABSOLUTELY FREE OF CHARGE,**

2,500 6-volt. 40 amp. "BLOCK" ACCUMULATORS

each listed at £2 8s. 9d. a total of over £7,000 to our next 2,500 customers who place an order for certain of our goods to the value of £5 or over. In doing so, we are confident that it will be money well spent, as the many thousands of testimonials we have received from all parts of the world positively ensure that the "BLOCK" Accumulator, when once used, will prove to the user all that is claimed for it.

In framing an offer of this magnitude it is of course necessary to make a few stipulations. Briefly these are as follows :

- (i.) Only one free Accumulator will be allowed to any one customer.
- (ii.) The offer will open with all orders received by first post on Saturday morning (May 12th, 1923), and no claims for the free Accumulator in respect of orders received prior to that date will be entertained. One week's notice will be given of the withdrawal of the offer in the wireless press, and after the date then specified no claims for the free Accumulator will be entertained.
- (iii.) In order that the Trade may extend the same offer to individual customers, we invite bona-fide retailers to write to us for particulars.
- (iv.) Orders to be eligible for this free gift must be made up of any of the following items from our Catalogue :— Accumulators, High-tension Batteries, Variometers, Coil Holders, Sets of Parts for home-made Sets, Loud Speakers, Variable Condensers, Rheostats, Transformers, Valve Holders, Aerial Wire, Lead-in Tubes, Terminals.

Polished Teak Cases to hold this size Accumulator, with leather strap, outside terminals, etc., can be supplied, if desired at 10s. 6d. each.

Send for our Illustrated Catalogue.

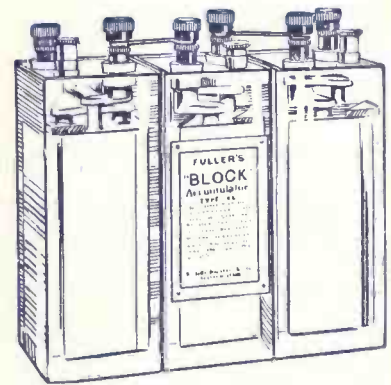

THE CITY ACCUMULATOR CO.,

79, MARK LANE, LONDON, E.C.3 Phone: AVENUE 1316.

(Agents where the free Accumulators may also be obtained)

- LANCASHIRE and CHESHIRE :**
Henry Hollingdrake & Son, Ltd., Princes Street, Stockport.
- SOUTH WALES :**
South Wales Wireless Installations Co., Ltd., 18, West Bute Street, Cardiff, and at Cambrian Road, Newport.
- WEST RIDING OF YORKSHIRE :**
Messrs. H. Wadsworth Sellers & Co., Standard Buildings, Leeds.

- GLOUC., SOMERSET and WILTS :**
Bristol Wireless Co., 52, Cotham Hill, Bristol.
- LEICESTERSHIRE :**
Walter Rowe, Ltd., Eldon House, 97, London Road, Leicester.
- FRANCE :**
33, Rue d'Hauteville, Paris.

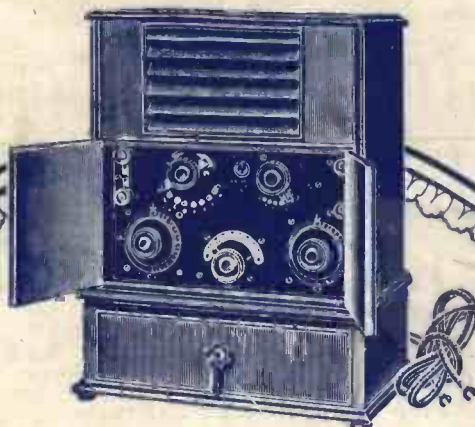

Radio Hints.

No. 1.

A lead from the negative side of battery to earth will invariably stop howling in low frequency amplifier.

Until you have used **R.I.** sets and components, it is impossible to appreciate the character of quality behind the name Radio Instruments engraved on all **R.I.** products. The complete set of components required to build the famous S.T. 100 circuit can be supplied ready for mounting.

Write for illustrated catalogue now.

RADIO INSTRUMENTS, LIMITED.

Managing Director : J. JOSEPH, M.I.E.E.
Chief Designer : W. A. APPLETON, M.B.E., M.I.R.E.,
Late Admiralty Technical Research Office.

Only Address, Works, Offices, and Showrooms :

**12, HYDE STREET,
NEW OXFORD STREET, W.C.1**

Telephone :
Regent 6214-6215-6216.

Telegrams :
"Instradio, London."

